

Directions for Use

Alaris® System
(with PC Unit, Model 8000)

Supports Guardrails® Suite MX with Guardrails® Point-Of-Care software and v9 Operating System software.

February 2007

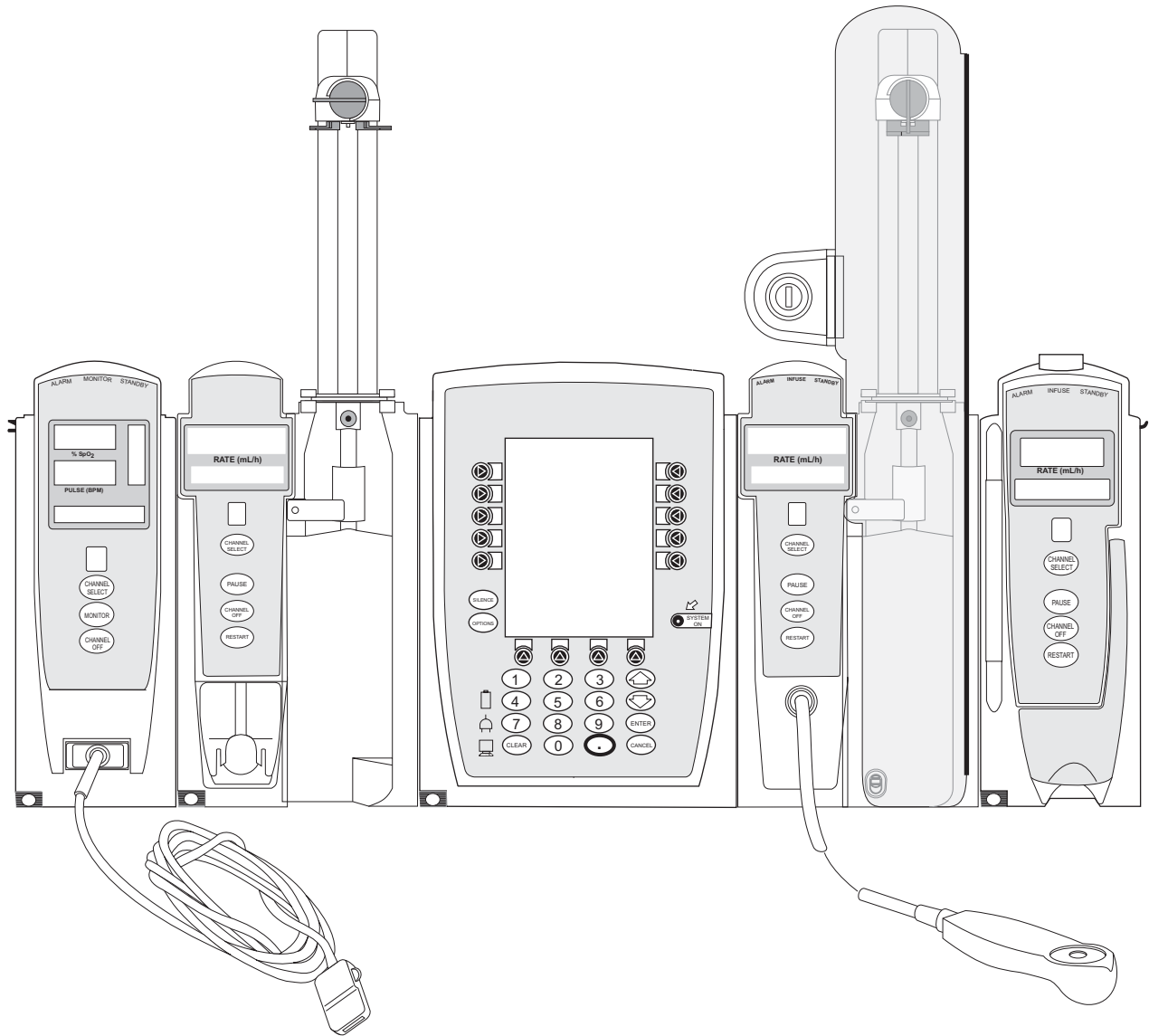

Table of Contents

Each of the Alaris® product-specific Sections has its own table of contents.

General Contact Information	i
Introduction	ii
Installation.....	iv
PC Unit	1
Pump and Syringe Modules	2
PCA Module	3
SpO ₂ Module.....	4
EtCO ₂ Module	5
Auto-ID Module	6
Nurse Call Accessory	7
Communications Interface Board Accessory	8
Appendix	
Maintenance.....	A-1
Cleaning	A-1
Service Information.....	A-2
Warranty	A-3
Regulations and Standards	A-5
Compliance	A-5
Trademarks	A-14

Order Numbers:

Electronic Copy: 10015905

Printed Copy: 10110697

©2006, 2007 Cardinal Health, Inc. or one of its subsidiaries. All rights reserved.

General Contact Information

Cardinal Health
Alaris® Products
10221 Wateridge Circle
San Diego, California 92121
cardinal.com/alaris

Customer Advocacy - North America

Clinical and technical feedback.

Phone: 800.854.7128, Ext. 7812

E-Mail: CustomerFeedback@cardinal.com

Technical Support - North America

Maintenance and service information support; troubleshooting.

United States - Phone:

858.458.6003
800.854.7128, Ext. 6003

Canada - Phone:

Within Canada: 800.387.8309
From United States: 800.908.9918

Customer Care - North America

Instrument return, service assistance, and order placement.

United States - Phone: 800.482.4822

Canada - Phone: 800.387.8309

Introduction

The Alaris® PC unit Section of this Directions for Use ("DFU") provides procedures and information applicable to the Alaris® System and the PC Unit. Each of the other major Sections provides product-specific procedures and information.

The Alaris® System is a modular system intended for adult, pediatric and neonatal care in today's growing professional healthcare environment. It consists of the PC Unit, the Guardrails® Suite MX, and up to 4 detachable infusion and/or monitoring modules (channels). The Auto-ID Module can be included as a fifth module.

Guardrails® Suite MX for the Alaris® System brings a new level of medication error prevention to the point of patient care. The Guardrails® Suite MX features medication dosing, concentration delivery rate and optional initial programming guidelines for up to 15 patient-specific care areas, referred to as profiles. Each profile contains a specific Drug Library and channel labels, as well as instrument configurations appropriate for the care area. Optional drug-specific Clinical Advisories provide visual messages. Dosing limits for each Guardrails® drug entry may be a Hard Limit that cannot be overridden during infusion programming and/or a Soft Limit that can be overridden, based on clinical requirements.

A Data Set is developed and approved by the facility's own multi-disciplinary team using the Editor Software, the PC-based authoring tool. A Data Set is then transferred to the Alaris® System by qualified personnel. The approved Data Sets are maintained by the Editor Software for future updates and reference.

Information about an Alert that occurs during use is stored within the PC Unit, and can be accessed using the CQI Reporter.

Documentation provided with Alaris® System products may reference product not present in your facility or not yet available for sale in your area.

A superscript number (for example, ^①) identifies additional information provided as a NOTE at the end of the procedure.

WARNING

Read all instructions before using the Alaris® System.

CAUTION

Rx Only

Introduction (Continued)

WARNINGS AND CAUTIONS:

Product-specific warnings and cautions, covered in the applicable Sections of this DFU, provide information needed to safely and effectively use the Alaris® System.

A **◀ DANGER ▶** is an alert to an imminent hazard which could result in serious personal injury and/or product damage if proper procedures are not followed.

A **WARNING** is an alert to a potential hazard which could result in serious personal injury and/or product damage if proper procedures are not followed.

A **CAUTION** is an alert to a potential hazard which could result in minor personal injury and/or product damage if proper procedures are not followed.

DEFINED TERMS:

The following table identifies the defined terms used throughout this document for certain products and product features.

<u>Product / Feature</u>	<u>Defined Term</u>
Alaris® Auto-ID module	Auto-ID Module
Alaris® EtCO ₂ module	EtCO ₂ Module
Alaris® Mobile Systems Manager	Mobile Systems Manager
Alaris® PCA module	PCA Module
Alaris® PC point-of-care unit	PC Unit
Alaris® Pump module	Pump Module
Alaris® SpO ₂ module	SpO ₂ Module
Alaris® Syringe module	Syringe Module
Alaris® System Maintenance	System Maintenance
Alaris® Systems Manager	Systems Manager
Guardrails® alert	Alert
Guardrails® clinical advisory	Clinical Advisory
Guardrails® CQI Reporter	CQI Reporter
Guardrails® data set	Data Set
Guardrails® drug library	Drug Library
Guardrails® Editor	Editor Software
Guardrails® hard limit	Hard Limit
Guardrails® IV fluid	IV Fluid
Guardrails® limit	Limit
Guardrails® PCA pause protocol	PCA Pause Protocol
Guardrails® soft limit	Soft Limit
SmartSite® needle-free valve	Needle-Free Valve
SmartSite® positive bolus needle-free valve	Needle-Free Valve

Installation

Instruments are tested and calibrated before they are packaged for shipment. To ensure proper operation after shipment, it is recommended that an incoming inspection be performed before placing the instrument in use.

Prior to placing the Alaris® System in use:

1. Perform check-in procedure using System Maintenance software.
2. Verify whether or not Profiles feature has been enabled (see PC Unit Section, "System Options", "System Configurations").^①

NOTE:

- ^① To enable the Profiles feature, a hospital-defined best-practice Data Set must be uploaded to the PC Unit.

Alaris® PC Unit Model 8000

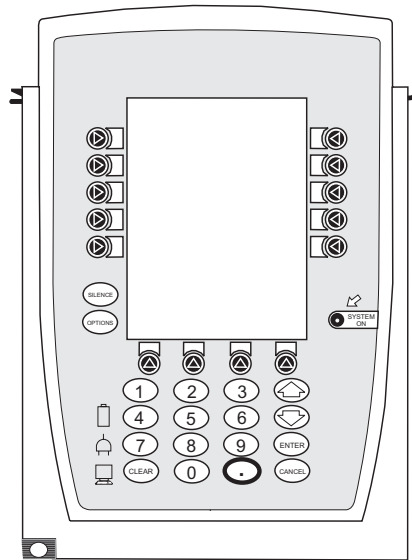

GETTING STARTED

INTRODUCTION.....	1-1
-------------------	-----

GENERAL SETUP AND OPERATION

ATTACHING AND DETACHING MODULES.....	1-3
Attaching Module(s).....	1-3
Detaching Module(s).....	1-4
Adding Module(s) While System is Powered On.....	1-4
START-UP.....	1-5
Powering On System.....	1-5
Responding to Maintenance Reminder.....	1-6
Adjusting Display Contrast.....	1-6
Selecting New Patient and Profile Options.....	1-7
Adjusting Audio Volume.....	1-9
Locking/Unlocking Tamper Resist.....	1-10
POWER OFF SYSTEM.....	1-11
SYSTEM OPTIONS.....	1-11
Display Contrast.....	1-11
Patient ID.....	1-12
Clinician ID.....	1-14
Power Down All Channels.....	1-15
Anesthesia Mode.....	1-16
Battery Runtime.....	1-19
System Configurations.....	1-19
Serial Numbers.....	1-21
Software Versions.....	1-22
Time of Day.....	1-23
Network Status.....	1-24
Wireless Connection.....	1-26
Data Set Status.....	1-27
Maintenance Due.....	1-28

GENERAL INFORMATION

WARNINGS AND CAUTIONS.....	1-31
General.....	1-31
Electromagnetic Compatibility.....	1-32
FEATURES AND DISPLAYS.....	1-33
Features and Definitions.....	1-33
Operating Features, Controls, Indicators.....	1-35
Displays.....	1-37
SYSTEM CONFIGURABLE SETTINGS.....	1-38
SPECIFICATIONS AND SYMBOLS.....	1-39
Specifications.....	1-39
Symbols.....	1-40

TROUBLESHOOTING AND MAINTENANCE

GENERAL.....	1-43
ALARM, ERRORS, MESSAGES.....	1-43
Definitions.....	1-43
Audio Characteristics.....	1-44
Alarms.....	1-45
Errors.....	1-45
Messages.....	1-46
STORAGE.....	1-47
BATTERY CARE AND MAINTENANCE.....	1-47
Battery Type and Charging.....	1-47
Battery Charge.....	1-48
Battery Care.....	1-48
Battery Cautions and Disposal.....	1-48
INSPECTION REQUIREMENTS.....	1-49

Introduction

This Section of the DFU provides PC Unit (Model 8000) and Alaris® System instructions and information. It is used in conjunction with:

- PC Unit / Pump Module Technical Service Manual
- Product-specific sections of this DFU
- System Maintenance software (and its instructions) for Alaris® System check-in, maintenance, and wireless configuration

The PC Unit is the core of the Alaris® System and provides a common user interface for programming infusions and monitoring, which helps to reduce complexity at the point of care.

Alarms, Errors, Messages: See "Troubleshooting and Maintenance" for specific PC Unit alarms, errors and messages.

Contraindications: None known.

Electromagnetic Environment: See "Appendix" Section of this DFU ("Regulations and Standards", "Compliance").

WARNING

Read all instructions, including those for the attached module(s) and applicable accessories, before using the Alaris® System.

CAUTION

Rx Only

THIS PAGE
INTENTIONALLY
LEFT BLANK

Attaching and Detaching Module(s)

Modules can be attached to either side of the PC Unit or to either side of another module. The process to attach or detach is the same for either side, whether attaching/detaching to/from a PC Unit or another module.

Attaching Module(s) ① ② ③

1. Position free module at a 45° angle, aligning IUI connectors.
2. Rotate free module down against PC Unit or attached module, until release latch snaps in place.

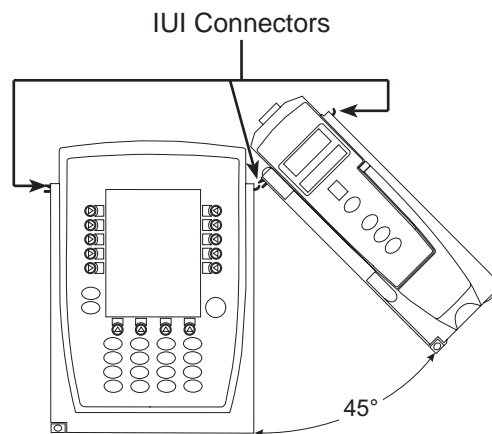

WARNING

When properly secured/snapped, the **release latch** provides a very secure connection between modules. If not properly latched, a module can be dislodged during operation.

NOTES:

- ① Individual hospital/facility may choose to permanently attach modules. To remove permanently attached modules, contact qualified service personnel.
- ② Application of adhesive tape or other materials to the sides of the PC Unit and modules may prevent proper latching.
- ③ The Alaris® System is designed to operate a maximum of 4 infusion or monitoring modules. Modules added in excess of 4 are recognized by the system. The Auto-ID Module can be included as a fifth module. The module(s) can be attached in any position; however, when mounted on an IV pole, it is recommended that a balanced configuration be maintained.

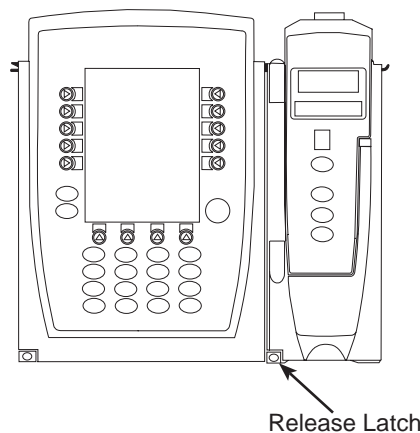

Attaching and Detaching Modules (Continued)

Detaching Module(s)

1. Ensure module(s) is powered off before detaching.
2. Push module release latch and then rotate module(s) up and away from PC Unit or attached module (opposite to motion shown above) to disengage connectors.
 - Alaris® System reidentifies and shows appropriate module identification (A, B, C or D), from left to right.
 - Appropriate module position(s) (A, B or C) for remaining module(s) appear on Main Display.

Adding Module(s) While System is Powered On ^①

Add module as described in "Attaching Module(s)".

- System tests module, causing all LED segments and indicator lights of displays to illuminate briefly.
- Appropriate module identification display (A, B, C or D) illuminates. Modules are always labeled left to right, so if a module is added to left of other modules, all modules are reidentified. Module reidentification does NOT interrupt or affect infusion or monitoring on active modules.
- Module positions (A, B, C or D) appear on Main Display.

NOTE:

- ① If any of the following conditions are observed, the affected module must be removed from use and inspected by qualified personnel:
- LED segments are not illuminated on displays during power-on test.
 - Indicator lights do not illuminate.
 - Appropriate module identification (A, B, C or D) is not displayed.

If the affected module operates normally when it is attached via the alternate IUI connector, it may be used until a replacement module can be substituted.

Start-Up

Powering On System ^① ^②

1. Connect PC Unit to an external AC power source.
2. Press **SYSTEM ON**.
3. System self test begins:
 - Diagnostics test causes all LED display segments and Status Indicator lights of attached module(s) to illuminate briefly.
 - Power Indicator illuminates.
 - Appropriate module identification (A, B, C or D) displays on attached module(s).
 - An Audio tone sounds.
 - If PM Reminder option is enabled and scheduled preventive maintenance is due, **MAINTENANCE REMINDER** screen appears.
 - At completion of system-on test, **New Patient?** screen appears.

NOTES:

- ① Previous infusion parameters are automatically cleared after 8 hours.
- ② If any of the following conditions are observed, the PC Unit or the affected attached module must be removed from use and inspected by qualified personnel:
 - LED segments are not illuminated during system-on test.
 - Indicator lights do not illuminate.
 - Appropriate module identification (A, B, C or D) is not displayed.
 - Audio tone does not sound.
 - Main Display does not appear backlit, appears irregular, or has evidence of a row of pixels not functioning properly.

If the affected module operates normally when it is attached via an alternate IUI connector, it may be used until a replacement module can be substituted.

Start-Up (Continued)

Responding to Maintenance Reminder ① ②

If the Preventive Maintenance (PM) Reminder option is enabled and the PC Unit or an attached module is due for preventive maintenance, a **MAINTENANCE REMINDER** message appears at power up.

1. Remove and, if needed, replace module requiring maintenance with a new module (see "Attaching and Detaching Modules").
2. If Alaris® System was powered off to replace PC Unit, reinitiate start-up process.

OR

If an attached module (such as a Pump Module) was powered off and removed, **MAINTENANCE REMINDER** display reflects removal of that module. To continue start-up process, press **CONFIRM** soft key.

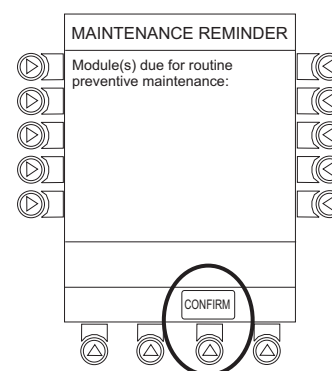
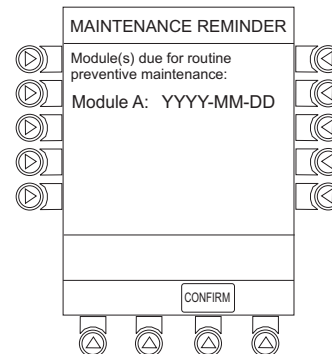

NOTES:

- ① If necessary, the reminder can be temporarily bypassed by pressing the **CONFIRM** soft key.
- ② Notify the appropriate facility personnel when a **MAINTENANCE REMINDER** occurs.

Adjusting Display Contrast

1. Press **DISPLAY CONTRST** soft key.

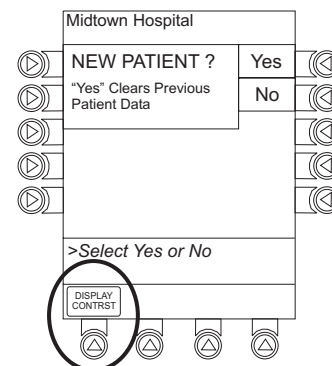

Start-Up (Continued)

Adjusting Display Contrast (Continued)

- To adjust display for optimum viewing, use **Lighter/Darker** soft keys.
- To return to main screen, press **CONFIRM** soft key.

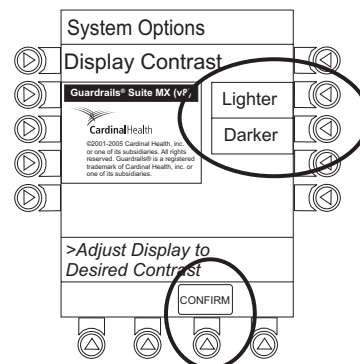

Selecting New Patient and Profile Options

The following procedures assume the Profiles feature is enabled.

- Select required **NEW PATIENT?** option.
 - To indicate programming is for a new patient and clear all stored patient parameters from memory, press **Yes** soft key.
 - OR**
 - To confirm programming is for same patient and retain all stored patient parameters, press **No** soft key.
 - Last used profile displays. ^①

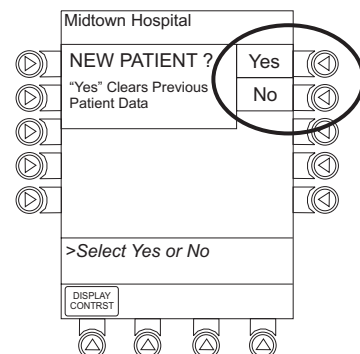

- Accept or change current profile:
 - To accept current profile, press **Yes** soft key.
 - Main screen appears.
 - To change profile, press **No** soft key and continue with next step.
 - Profile selection screen appears.

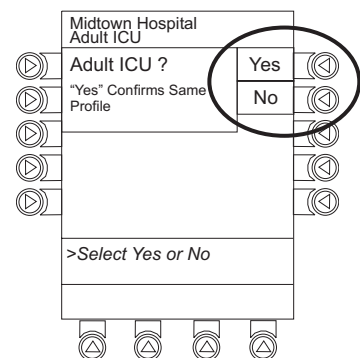

Start-Up (Continued)

Selecting New Patient and Profile Options (Continued)

- To select a profile, press corresponding left soft key. ②
- To confirm profile selection, press **CONFIRM** soft key.
 - Main screen appears.

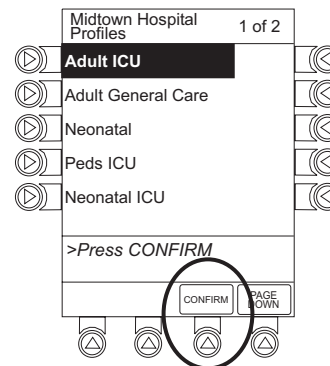

NOTES:

- If the Profiles feature is disabled, the main menu appears.
- To view additional choices, press **PAGE DOWN** soft key.

Patient ID Entry Feature

The option to enter and display a 16-character alphanumeric patient identifier is always available. The instrument may be configured to automatically display the **Patient ID Entry** screen during start-up or to provide access only through the **Systems Options** menu (see "System Options").

If **Yes** was selected to indicate programming for a new patient, perform one of following steps:

- If patient identifier is not required, press **CONFIRM** or **EXIT** soft key.
- To manually enter patient identifier, use numeric data entry keys and/or alpha speed keys. ① ② ③ ④ ⑤
- To scan bar code on patient identification band, see Auto-ID Module Section of this DFU.

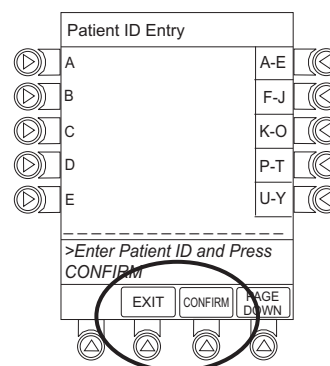

Start-Up (Continued)

Selecting New Patient and Profile Options (Continued)

Patient ID Entry Feature (Continued)

NOTES:

- ① An alphanumeric identifier, of up to 16 characters, can be entered.
- ② Press the soft key next to a letter group to list letters in that group. Press the soft key next to an individual letter to enter that letter.
- ③ To access the letter "Z" and special characters (hyphen, underscore, space), press the **PAGE DOWN** soft key.
- ④ To clear an entire entry, press **CLEAR** key.
- ⑤ To back up a single character at a time, press **CANCEL** key.

Adjusting Audio Volume

1. Press **AUDIO ADJUST** soft key.

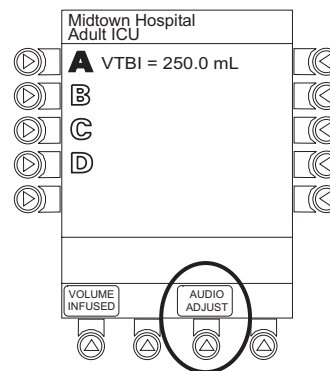

2. To change volume to desired level, press either **Louder** or **Softer** soft key. To sample alarm loudness level, press **Test** soft key.
3. To return to PC Unit screen, press **MAIN SCREEN** soft key.
 - After 30 seconds without a key press, Main Display appears.

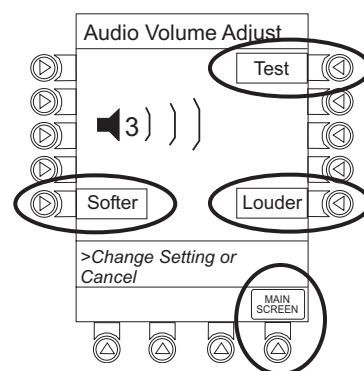

Start-Up (Continued)

Locking/Unlocking Tamper Resist

1. Initiate operation of applicable module(s).
2. Press and hold Tamper Resist Switch, on back of PC Unit, for 3 to 4 seconds (see "General Information", "Features and Displays", "Operating Features, Controls, Indicators").
 - An advisory tone (if **Key Click Audio** is enabled) and a three-second **PANEL LOCKED** prompt on Main Display confirm activation.
 - When Tamper Resist is active, keypad panel is locked; however, clinician may:
 - ◆ Silence audio alarm.
 - ◆ View volume(s) infused.
 - ◆ View and test audio alarm setting.
 - ◆ View selected parameters on attached modules.

Any other key press results in a visual **PANEL LOCKED** prompt and, if **Key Click Audio** is enabled, an illegal key-press audio advisory.

3. To unlock keypad panel, press and hold Tamper Resist Switch for 3 to 4 seconds.
 - An advisory tone (if **Key Click Audio** is enabled) and a three-second **PANEL UNLOCKED** prompt on Main Display confirm activation.

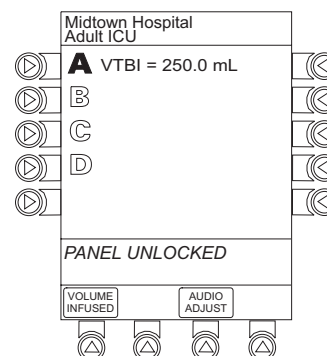
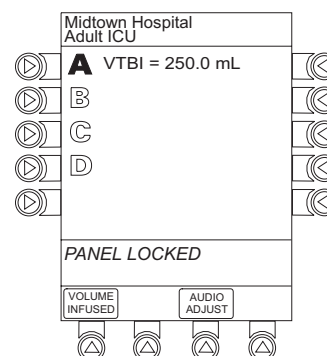

Power Off System

Press and hold **CHANNEL OFF** key until a beep is heard (approximately 1.5 seconds) and then release to initiate power down. ①

- During power off sequence, Main Display flashes **Powering Down**.
- Once all attached modules are powered off, PC Unit automatically powers down.

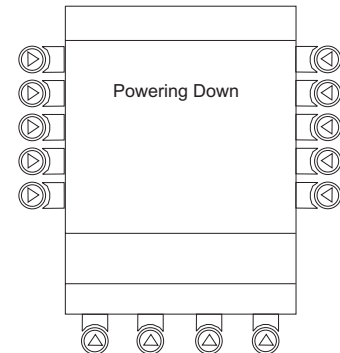

NOTE:

- ① To interrupt the power down sequence, quickly press any key (except **SYSTEM ON**) on the PC Unit.

System Options

Display Contrast

1. Press **OPTIONS** key.

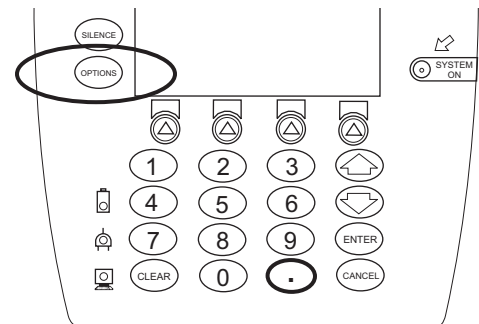

2. Press **Display Contrast** soft key.

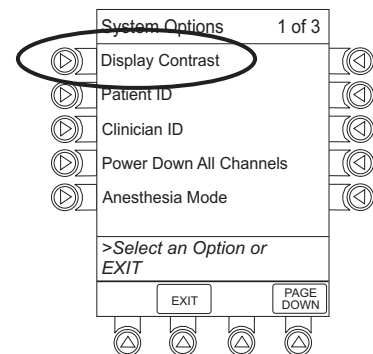

3. Adjust display and return to main screen (see "Start-Up", "Adjusting Display Contrast" procedure).

System Options (Continued)

Patient ID

Entering

1. Press **OPTIONS** key.
2. Press **Patient ID** soft key.

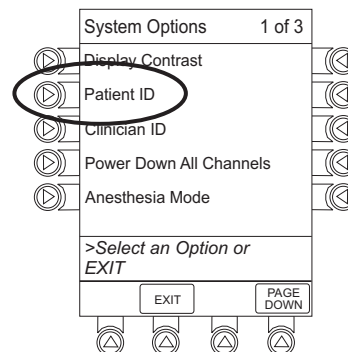

3. Scan or manually enter patient identifier:
 - To manually enter patient identifier, use numeric data entry keys and/or alpha speed keys. ① ② ③ ④ ⑤
 - To scan bar code on patient identification band, see Auto-ID Module Section of this DFU.
4. To verify correct entry, press **CONFIRM** soft key.

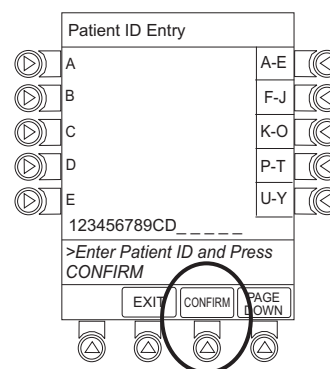

System Options (Continued)

Patient ID (Continued)

Modifying

1. Press **OPTIONS** key.
2. Press **Patient ID** soft key.
3. To clear entire entry, press **CLEAR** key.

OR

To back up a single character at a time, press **CANCEL** key.

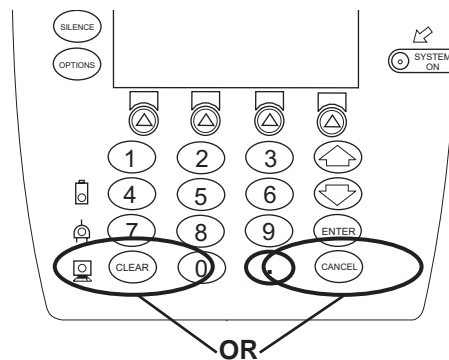

4. To enter modified patient identifier, use numeric data entry keys and/or alpha speed keys. ① ② ③
5. To verify correct entry, press **CONFIRM** soft key.
 - New **Patient ID Entry** verification screen appears.

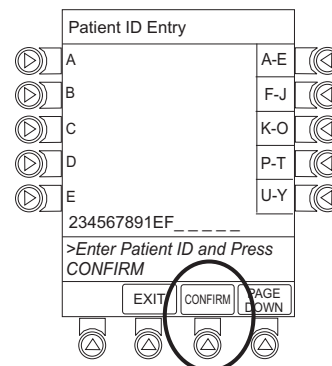

System Options (Continued)

Patient ID (Continued)

Modifying (Continued)

- To accept modified Patient ID, press **Yes** soft key.
 - Main screen appears with new Patient ID.

OR

To retain original (old) Patient ID, press **No** soft key.

 - Main screen appears with old Patient ID.

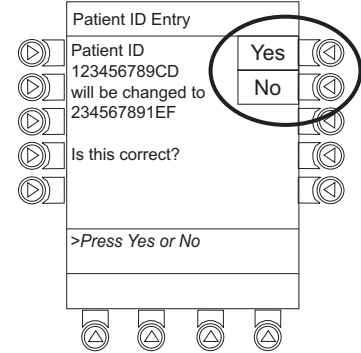

NOTES:

- An alphanumeric identifier, of up to 16 characters, can be entered.
- Press the soft key next to a letter group to list letters in that group. Press the soft key next to an individual letter to enter that letter.
- To access the letter "Z" and special characters (hyphen, underscore, space), press the **PAGE DOWN** soft key.
- To clear an entire entry, press **CLEAR** key.
- To back up a single character at a time, press **CANCEL** key.

Clinician ID

- Press **OPTIONS** key.
- Press **Clinician ID** soft key.

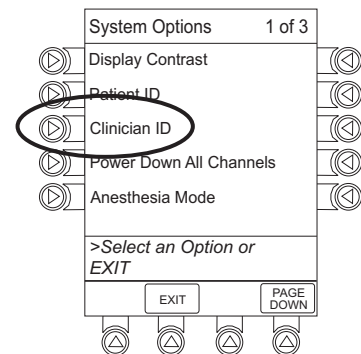

System Options (Continued)

Clinician ID (Continued)

- Scan or manually enter clinician identifier:
 - To manually enter clinician identifier, use numeric data entry keys and/or alpha speed keys. ① ② ③ ④ ⑤
- To verify correct entry, press **CONFIRM** soft key.

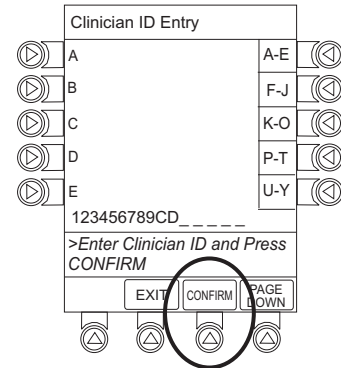

NOTES:

- ① An alphanumeric identifier, of up to 16 characters, can be entered.
- ② Press the soft key next to a letter group to list letters in that group. Press the soft key next to an individual letter to enter that letter.
- ③ To access the letter "Z" and special characters (hyphen, underscore, space), press the **PAGE DOWN** soft key.
- ④ To clear an entire entry, press **CLEAR** key.
- ⑤ To back up a single character at a time, press **CANCEL** key.

Power Down All Channels

- Press **OPTIONS** key.
- Press **Power Down All Channels** soft key.

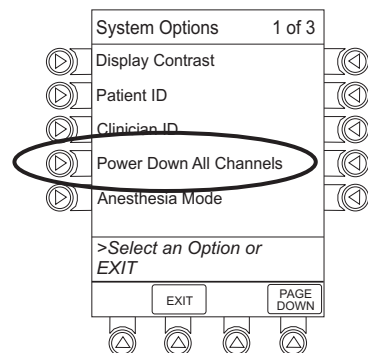

System Options (Continued)

Power Down All Channels (Continued)

- Press **Yes** soft key.
 - During power off sequence, Main Display flashes **POWERING DOWN**.

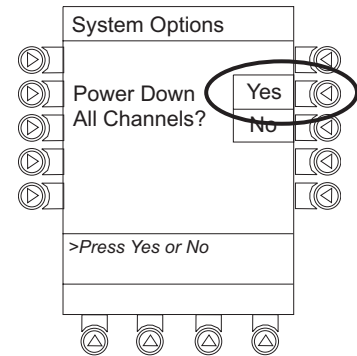

Anesthesia Mode

When the Anesthesia Mode is enabled while a module is paused, the module remains in an indefinite pause until restarted.

When Anesthesia Mode is enabled:

- All limits are set to **Soft**.
- Dose checking mode is set to **Smart**.
- Key-press audio is turned off.
- Tamper Resist Mode (panel locked) is not available.
- Guardrails® drug list defaults to drugs designated by Editor Software as anesthesia only. All Guardrails® drugs in a profile can be viewed by pressing **ALL DRUGS** soft key.
- Bolus dose is automatically available for:
 - Guardrails® drugs that have bolus dose limits defined
 - generic drug calculation setup
- Anesthesia Mode**, alternating with other required prompts, displays in prompt bar of Main Display.
- Callback audio for paused module is permanently silenced.
- Review of drug calculation setup page is omitted when restoring a stopped drug calculation.
- Clinical Advisories are not displayed.
- Auto-ID Module is not available.

CAUTION

When the Alaris® System is set up for use in Anesthesia Mode, it is important to **select the profile** that corresponds with the care area the patient will be taken to when the Anesthesia Mode is discontinued. This ensures that the Alaris® System will be in the correct profile following the use of the Anesthesia Mode.

System Options (Continued)

Anesthesia Mode (Continued)

Enabling

1. Press **OPTIONS** key.
2. Press **Anesthesia Mode** soft key.

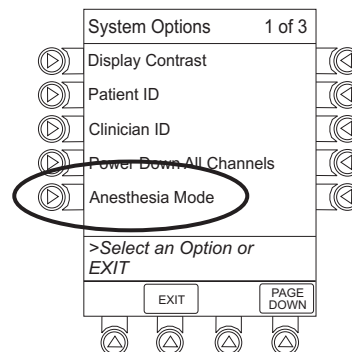

3. Press **Enable** soft key.
4. Press **CONFIRM** soft key.

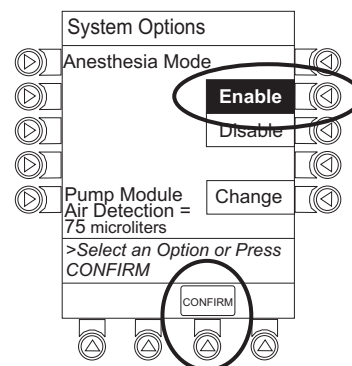

Disabling

The Anesthesia Mode can be disabled, and normal operation resumed, using either of the following three methods:

- System Options menu.
- Disconnecting from AC power.
- Connecting to AC power.

System Options (Continued)

Anesthesia Mode (Continued)

Disabling (Continued)

From System Options Menu

1. Press **OPTIONS** key.
2. Press **Anesthesia Mode** soft key.
3. Press **Disable** soft key.
4. Press **CONFIRM** soft key.
 - **Anesthesia Mode** no longer appears on Main Display, indicating it has been disabled.

Connecting To AC Power

1. Connect system to AC power.
2. To continue using Anesthesia Mode, press **Yes** soft key.

OR

To discontinue Anesthesia Mode, press **No** soft key.

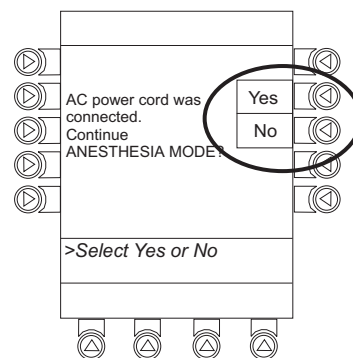

Disconnecting from AC Power

1. Disconnect system from AC.
 - Anesthesia Mode is automatically disabled.
 - All currently running infusions continue.
 - A prompt appears as an alert that Anesthesia Mode has been discontinued.
2. Press **CONFIRM** soft key.

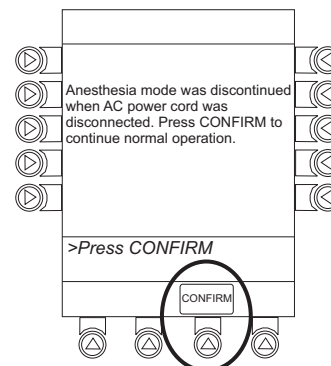

System Options (Continued)

Battery Runtime

1. Press **OPTIONS** key.
2. Press **PAGE DOWN** soft key.
3. Press **Battery Runtime** soft key.

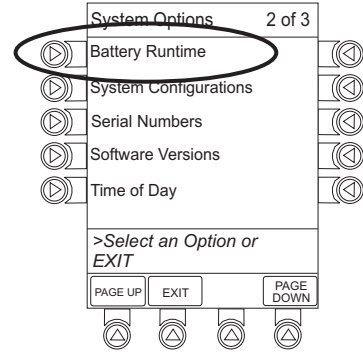

4. To return to main screen, press **CANCEL** key or **EXIT** soft key.

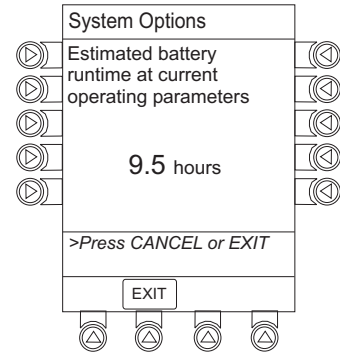

System Configurations

1. Press **OPTIONS** key.
2. Press **PAGE DOWN** soft key.
3. Press **System Configurations** soft key.

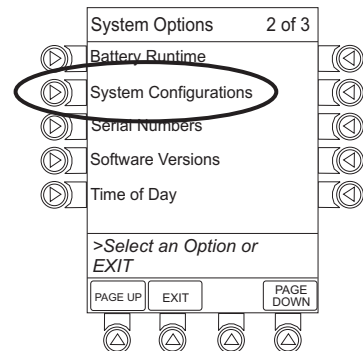

System Options (Continued)

System Configurations (Continued)

4. Press **PC Unit** soft key.

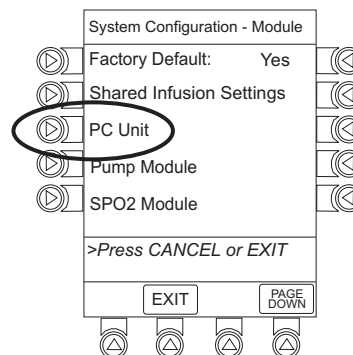

5. To review various system configuration settings, press **PAGE DOWN** and **PAGE UP** soft keys. ① ②

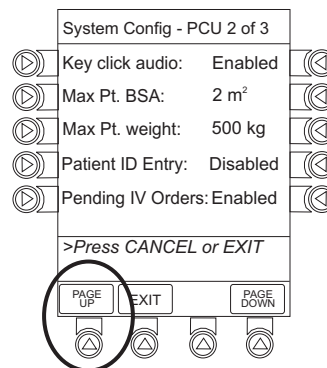
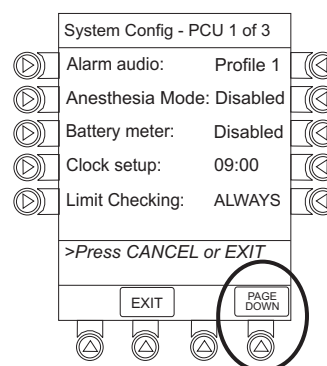

System Options (Continued)

System Configurations (Continued)

- To return to main screen, press **CANCEL** key or **EXIT** soft key.

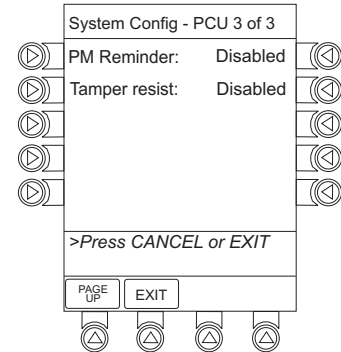

NOTES:

- The **Profiles** option is listed only if it is **disabled**.
- The **Limit Checking** (or **Dose Checking**), **Max Pt. BSA**, and **Pending IV orders** options are listed only if the **Profiles** option is **enabled** and a valid Data Set is loaded.

Serial Numbers

- Press **OPTIONS** key.
- Press **PAGE DOWN** soft key.
- Press **Serial Numbers** soft key.
 - Serial numbers for PC Unit and all attached modules display. ^①

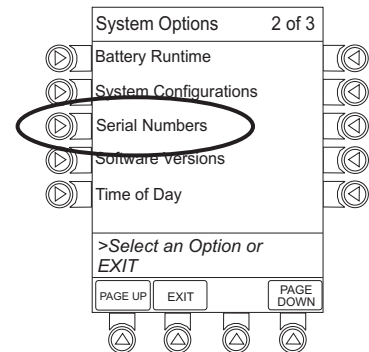

- To return to main screen, press **EXIT** soft key.

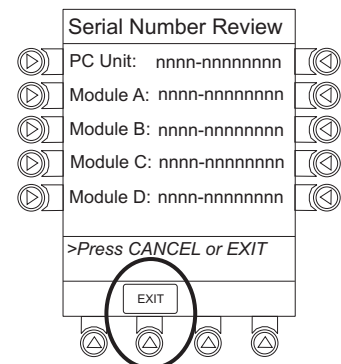

NOTE:

- "nnnn-nnnnnnnn" in the illustrated display represents a serial number.

System Options (Continued)

Software Versions

1. Press **OPTIONS** key.
2. Press **PAGE DOWN** soft key.
3. Press **Software Versions** soft key.

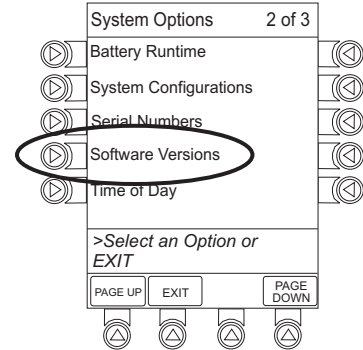

4. To review software version information, press **View** soft key next to applicable module.

OR

To return to main screen, press **EXIT** soft key.

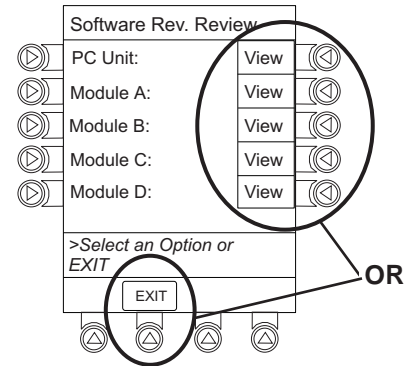

5. To return to previous screen, press **EXIT** soft key. ^①

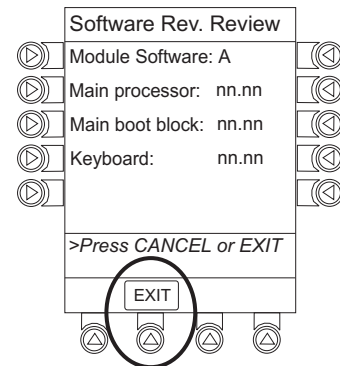

NOTE:

- ^① "nn.nn" in the illustrated display represents a software version.

System Options (Continued)

Time of Day ^①

1. Press **OPTIONS** key.
2. Press **PAGE DOWN** soft key.
3. Press **Time of Day** soft key.

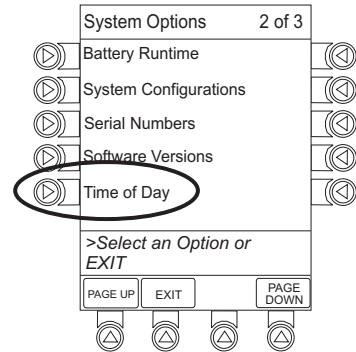

4. If time is correct, press **CONFIRM** soft key.
OR
To change time, press **Change Time** soft key.

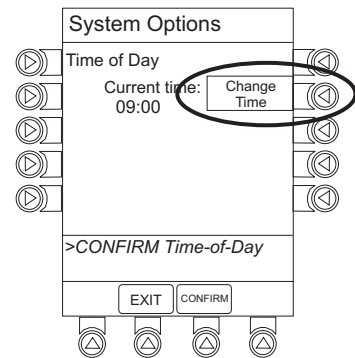

5. Enter current Time of Day.

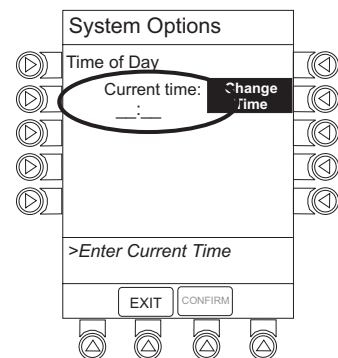

System Options (Continued)

Time of Day (Continued) ①

6. Press **CONFIRM** soft key.

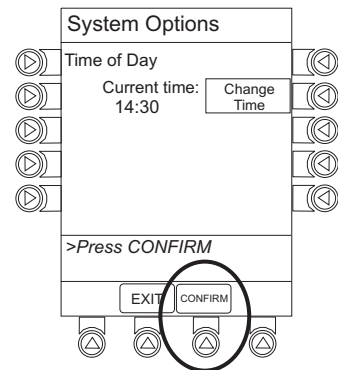

NOTE:

- ① The format is a 24-hour clock (military time).

Network Status

This option is available only when the Communications Interface Board Accessory is installed and the PC Unit has been flashed to support wireless communications with Alaris® Server or Mobile Systems Manager. The displayed status updates immediately when a status change takes place.

1. Press **OPTIONS** key.
2. Press **PAGE DOWN** soft key 2 times.
3. To view network status and wireless status information, press **Network Status** soft key.

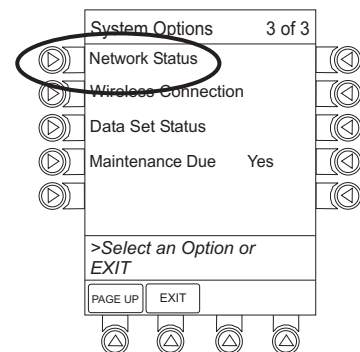

System Options (Continued)

Network Status (Continued)

- Enter password (can be found in System Maintenance software instructions).
 - Information based on a wireless status of **DISASSOCIATED**, **SCANNING**, **IDENTIFYING**, **ASSOCIATING**, or **ASSOCIATED** is displayed.
 - If wireless status is **ASSOCIATED**, wireless connectivity link quality and signal strength is identified.

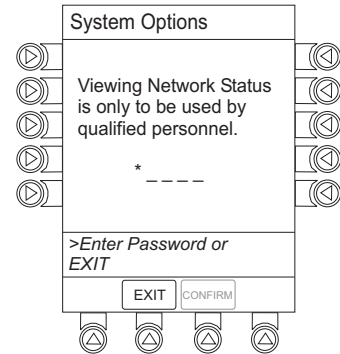

- To view network connectivity information, press **NET STATUS** soft key.
 - A status of **DISABLED**, **DISCONNECTED**, **CONFIGURING**, or **CONNECTED** is displayed.

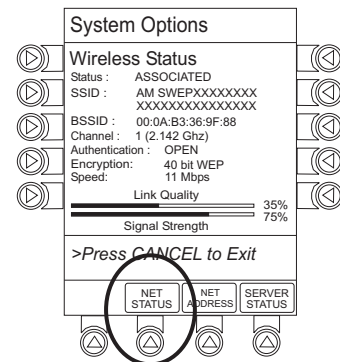

- To view network address information, press **NET ADDRESS** soft key.

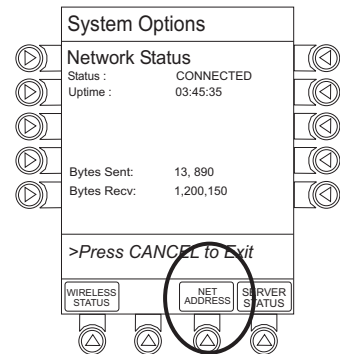

System Options (Continued)

Network Status (Continued)

- To view server connectivity information, press **SERVER STATUS** soft key.
 - Information based on a status of **DISABLED**, **SEARCHING**, **VERIFYING**, **CONNECTING**, or **CONNECTED** is displayed.

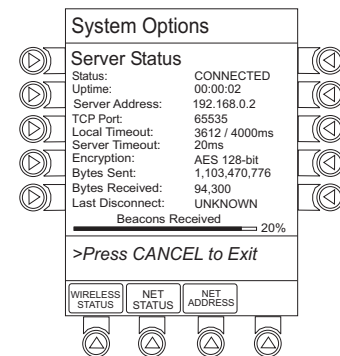
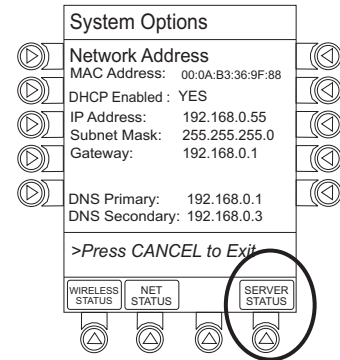

Wireless Connection

This option is available only when the Communications Interface Board Accessory is installed and the PC Unit has been flashed to support wireless communications with Alaris® Server or Mobile Systems Manager.

- Press **OPTIONS** key.
- Press **PAGE DOWN** soft key 2 times.
- Press **Wireless Connection** soft key.

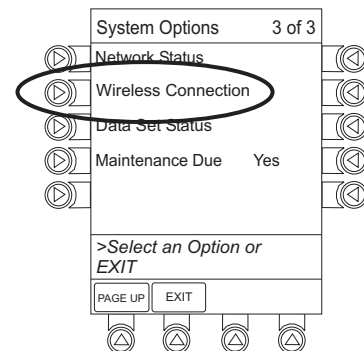

System Options (Continued)

Wireless Connection (Continued)

- To disable wireless communication, press **Disable** soft key.
OR
To enable wireless communication, press **Enable** soft key.

WARNING

To comply with FAA regulations and prevent potential interference with aircraft communications, **disable wireless communication** when the Alaris® System is used in an aircraft.

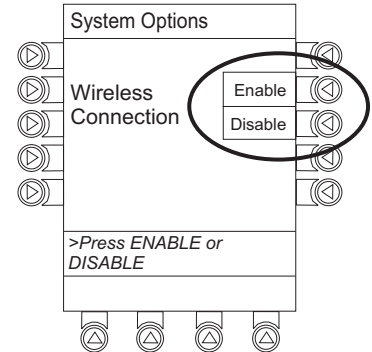

Data Set Status

- Press **OPTIONS** key.
- Press **PAGE DOWN** soft key 2 times.
- To view Data Set status, press **Data Set Status** soft key.

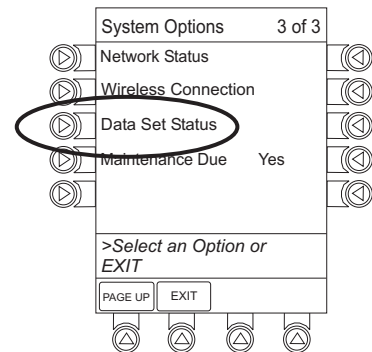

-- Continued Next Page --

System Options (Continued)

Data Set Status (Continued)

- A status of **Current**, **Pending**, **Transferring**, or **Not Activated** displays.

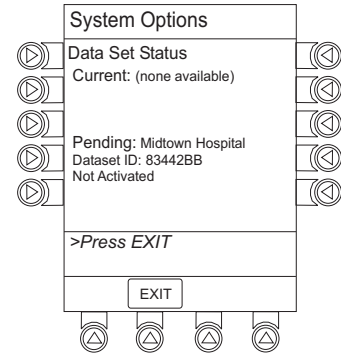

Maintenance Due

1. Press **OPTIONS** key.
2. Press **PAGE DOWN** soft key 2 times.
3. Press **Maintenance Due** soft key.

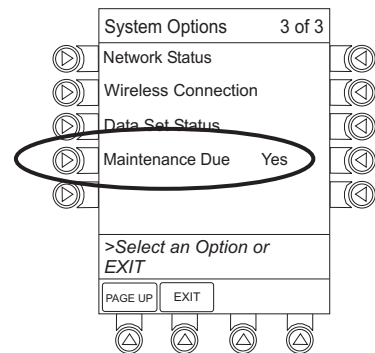

4. To return to main screen, press **EXIT** soft key. ^①

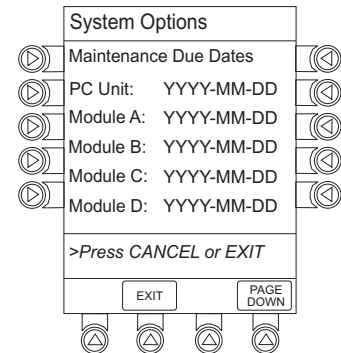

-- Continued Next Page --

System Options (Continued)

Maintenance Due (Continued)

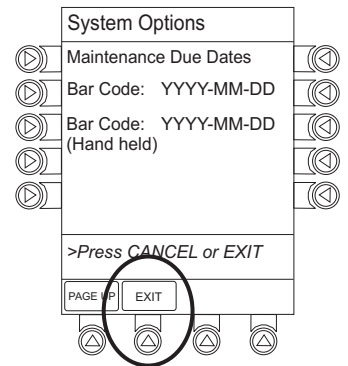

NOTE:

- ① **PAGE DOWN** soft key appears only if an Auto-ID Module is attached.

THIS PAGE
INTENTIONALLY
LEFT BLANK

Warnings and Cautions

◀ DANGER ▶

Explosion risk if used in the presence of flammable anesthetic agents or gasses.

General

WARNINGS

- Assess patient's condition **before silencing an alarm**. Do not silence alarm if patient safety might be compromised.
- Before each use, **verify the alarm limits** are appropriate for the patient.
- The Alaris® System performs a **self check during power up**. The PC Unit should beep, no errors should occur, and if a module is connected, all LED segments should flash. If the Alaris® System fails the self check, remove the failing PC Unit or module from use.
- When properly secured/snapped, the **release latch** provides a very secure connection between modules. If not properly latched, a module can be dislodged during operation.
- Disconnect from main (AC) and battery power when performing **maintenance**.
- Electrical shock hazard. **Do not open case**. Refer to qualified service personnel.
- To comply with FAA regulations and prevent potential interference with aircraft communications, **disable wireless communication** when the Alaris® System is used in an aircraft (see "System Options", "Network Status").
- The Alaris® System is not intended to replace **supervision by medical personnel**. The user must become thoroughly familiar with the Alaris® System features, operation and accessories prior to use.
- Always use a grounded, **three-wire receptacle**. Where the integrity of the protective earth grounding system is in doubt, operate on internal battery.

Warnings and Cautions (Continued)

General (Continued)

CAUTIONS

- **Hyperbaric Chamber Operation:**
 - ♦ The Alaris® System is not certified for use in oxygen-enriched environments.
 - ♦ The Alaris® System, with the exclusion of the EtCO₂ Module, has been verified to operate with no malfunction alarms due to the hyperbaric chamber environment or unintentional key presses when used in a hyperbaric chamber.
 - ♦ The healthcare facility's hyperbaric safety director is responsible for all equipment used in the hyperbaric chamber environment.
- Should an instrument or accessory be **dropped or severely jarred**, it should be immediately taken out of use and inspected by qualified service personnel, to ensure its proper function prior to reuse.
- If an instrument appears **damaged**, contact Cardinal Health for authorization to return it for repair.

Electromagnetic Compatibility

WARNINGS

- Do not use the Alaris® System near Magnetic Resonance Imaging (**MRI**), including Stereotaxis technology.
- Do not use the Alaris® System near **Therapeutic Radiation** equipment, such as Linear Accelerators.
- Use of any **accessory, transducer or cable** other than those specified may result in increased emissions or decreased Alaris® System immunity.

CAUTIONS

- The Alaris® System should not be used **adjacent to or stacked with other equipment**. If adjacent or stacked use is necessary, monitor the Alaris® System to verify it is operating normally in that setup.
- **Portable and mobile RF communications** can affect medical electrical equipment.

Warnings and Cautions (Continued)

Electromagnetic Compatibility (Continued)

CAUTIONS

- **Interconnected data communications systems** must be certified to IEC 60950 (data processing equipment) or IEC 60601–1 (electromedical equipment).
- The Alaris® System is intended for use by healthcare professionals only. This is a CISPR 11 Class B Group 2 medical system. In a domestic environment, this system **may cause radio interference**. Reorienting, relocating or shielding the system, or filtering the connection to the public mains network, are examples of steps that can be taken to reduce or eliminate interference.
- Medical electrical equipment **needs special precautions regarding EMC** and needs to be installed and used according to the EMC information provided in the "Appendix" Section of this DFU (see "Regulations and Standards", "Compliance").
- **Nurse call systems** must be certified to UL 1069 (hospital signaling and nurse call equipment) or comply with the requirements specified in IEC 60601–1.

Features and Displays

Features and Definitions

See the product-specific Section of this DFU that applies to the attached module(s) for features and definitions specific to that module.

Clinician ID	An optional alphanumeric 16-character clinician identifier that can be entered and displayed.
Data Set	Created using Editor Software authoring tool and then transferred to PC Unit. A Data Set reflects facility's best-practice guidelines for IV Drug administration and includes: Profile Drug Libraries, Clinical Advisories, instrument configurations, and Channel Label Libraries.

Features and Displays (Continued)

Features and Definitions (Continued)

Guardrails® Suite MX	<p>Designed to help prevent programming errors by:</p> <ul style="list-style-type: none">• Customizing device configurable settings to meet need of selected hospital/facility area/unit (profile).• Comparing user programming with hospital-defined best-practice guidelines.• Providing a visual and audio prompt if an out-of-limits entry is made.
Patient ID	<p>An optional alphanumeric 16-character patient identifier that can be entered and displayed.</p> <ul style="list-style-type: none">• When enabled, ID entry defaults to Startup screen.• When disabled, ID entry is only accessible from System Options screen.
Profile	<p>A unique set of system configuration settings and best-practice guidelines for a specific patient population or patient type, and can consist of following components:</p> <ul style="list-style-type: none">• Instrument configuration settings.• A Drug Library, which includes Drug names, standard concentrations, dosing units, duration limits, and optional associated Clinical Advisories for both continuous and bolus dose infusion.• An IV Fluid library, an optional library consisting of IV Fluids (for example, TPN) and limits around rate of delivery.• A Channel Label Library with text (alphanumeric) labels, which allows identification (on modules) that can be used to indicate route of delivery (for example, epidural). <p>Profile settings are established by the facility's own multi-disciplinary team prior to system implementation. Profile parameters are used to create a Data Set, which is then transferred to the PC Unit.</p>
System Configuration	<p>Allow system settings to be customized. If Profiles feature is enabled, system settings defined for selected profile are automatically activated.</p>
Tamper Resist	<p>Provides a quick one-touch lockout of front panel keypad.</p>

Features and Displays (Continued)

Operating Features, Controls, Indicators

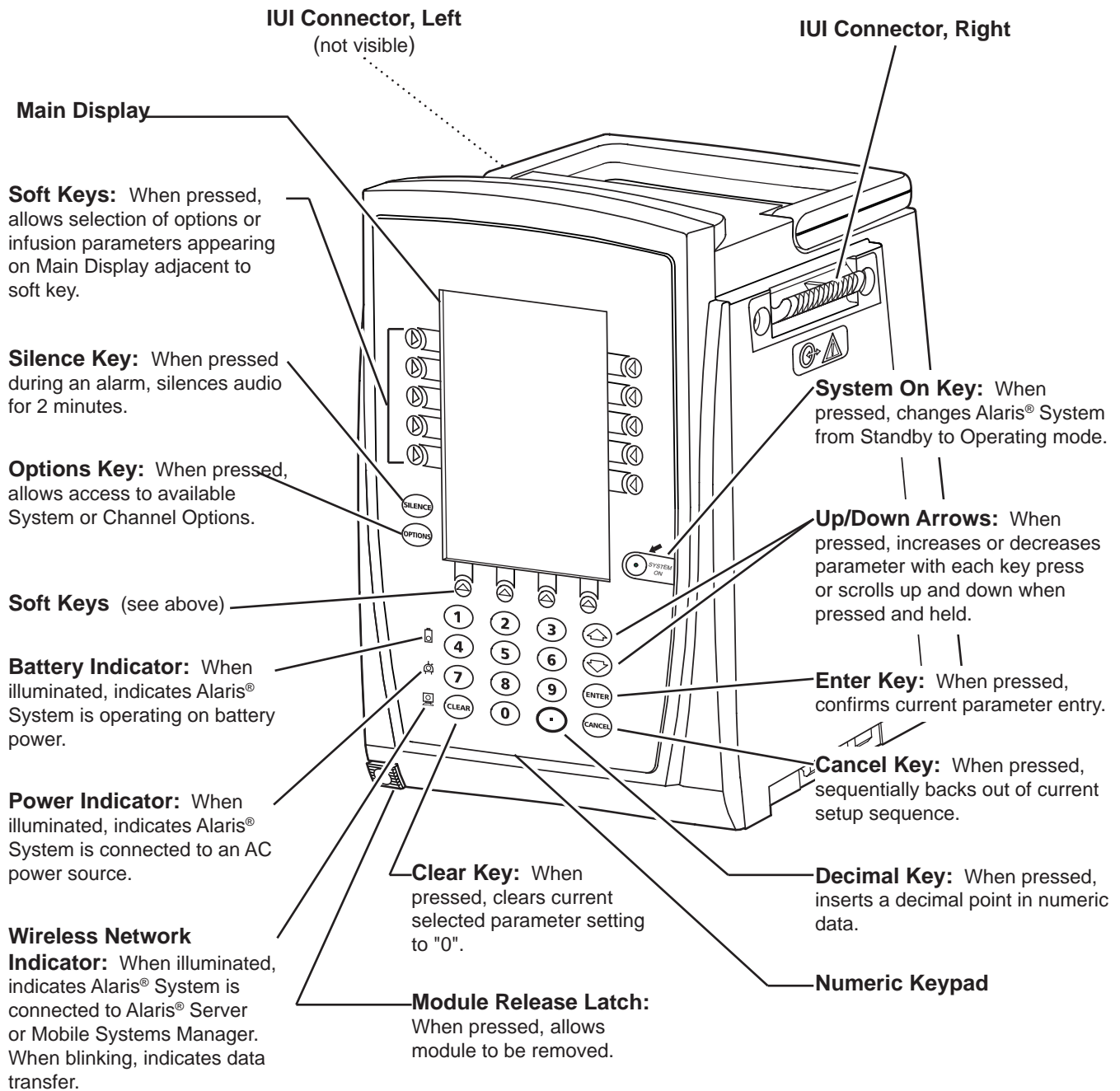

Features and Displays (Continued)

Operating Features, Controls, Indicators (Continued)

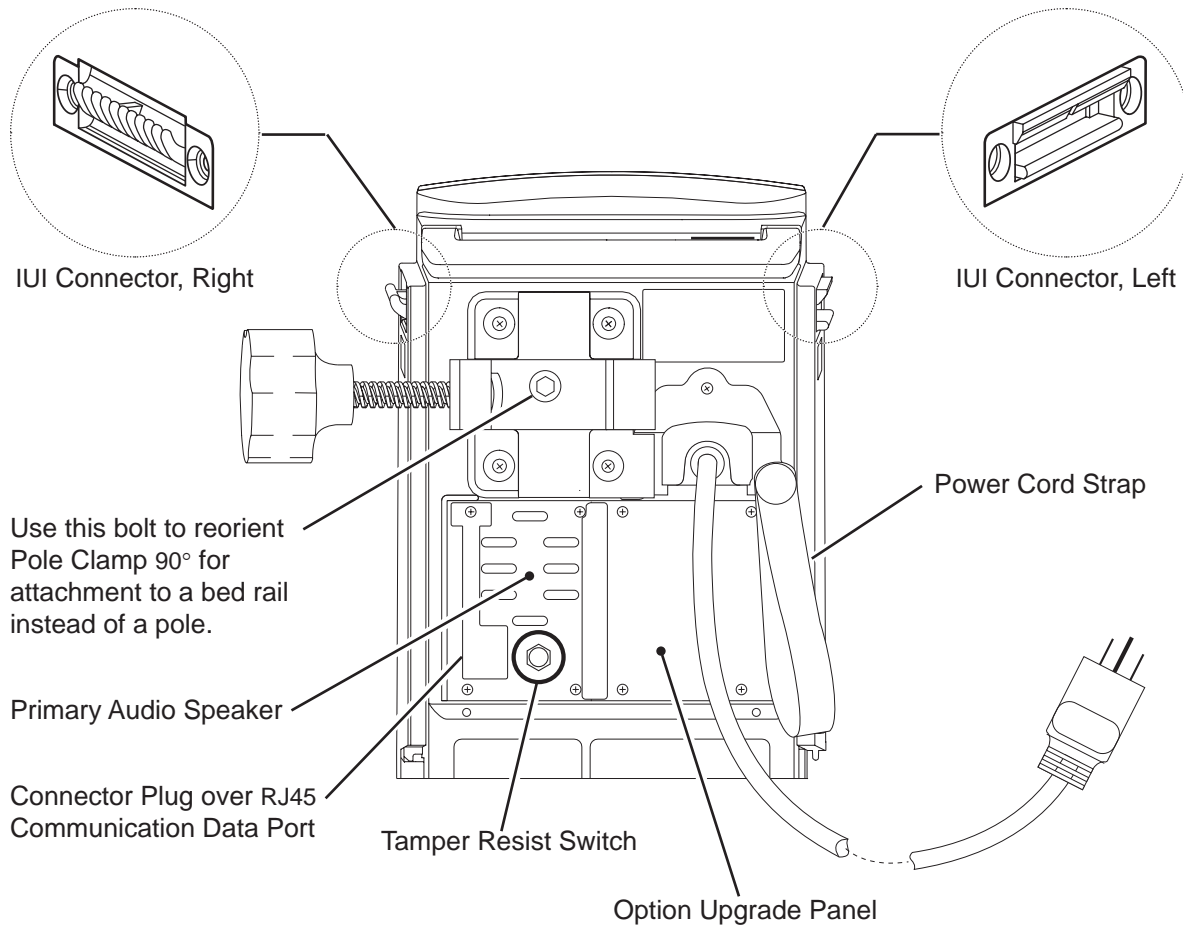

Features and Displays (Continued)

Displays

The displays illustrated throughout this document are for illustration purposes only. The display content varies, depending on configuration settings, hospital-defined Data Set uploaded using the Guardrails® Suite MX, and many other variables.

Main Display

Title Bar

Module Status

- A solid letter display indicates module is operating.
- An outlined letter display indicates module is attached and ready for use.

Soft Keys

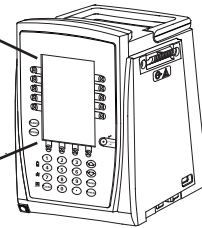
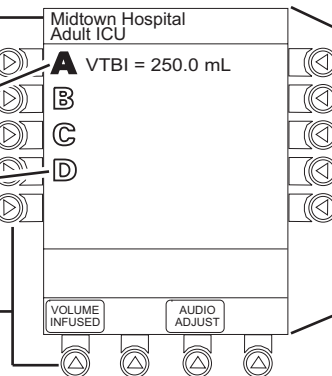

Module Selected Indicator

"Inactive" Soft Key

Nonhighlighted indicates a nonselected soft key.

"Active" Soft Key

Highlighted indicates a selected soft key.

Prompt Bar

Look here for user prompts.

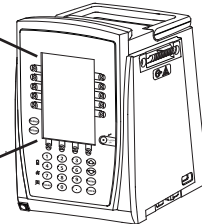
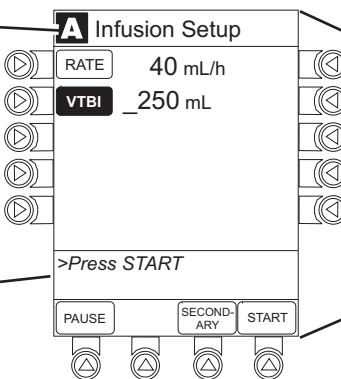

System Configurable Settings

If the configuration settings need to be changed from the **Factory default** settings, reference the applicable Technical Service Manual or contact Cardinal Health Technical Support, for technical, troubleshooting, and preventive maintenance information.

With the Profiles feature enabled, the settings are configured independently for each profile. A hospital-defined, best-practice Data Set must be uploaded to enable the Profiles feature. Date and Time is a system setting and is the same in all profiles.

Feature	Default Setting	Options
Alarm Audio	Profile 1	Profile 1, 2 or 3
Anesthesia Mode	Disabled	Enabled - Disabled
Battery Meter	Disabled	Enabled - Disabled
Clock Setup (Date and Time)	N/A	Set date and time
Dose Checking	Always	Always, Smart
Key Click Audio	Enabled	Enabled - Disabled
Max Patient Weight	500 kg	0.1 - 500 kg
Patient ID Entry	Disabled	Enabled - Disabled
PM Reminder (Preventive Maintenance)	Enabled	Enabled - Disabled
Profiles	Disabled	Enabled - Disabled
Tamper Resist	Disabled	Enabled - Disabled

Specifications and Symbols

Specifications

Battery Operation:	Battery run time is a function of the number of modules attached and module activity. With a new, fully charged battery, the system operates as follows before a "BATTERY DISCHARGED" message occurs: <ul style="list-style-type: none">• 6 hours with 1 Pump Module infusing at 25 mL/h• 6 hours with 1 Pump Module infusing at 25 mL/h and 1 Auto-ID Module• 3 hours with 4 Pump Modules infusing at 25 mL/h• 3 hours with 4 Pump Modules infusing at 25 mL/h and 1 Auto-ID Module• 4.5 hours with 1 active SpO₂ Module• 6 hours with 1 Syringe Module or PCA Module infusing at 5 mL/h• 3 hours with 4 Syringe Modules, or 1 PCA Module and 3 Syringe Modules, infusing at 5 mL/h• 4 hours with 1 active EtCO₂ Module	
Communication Data Port:	RS-232 with an RJ45 connector.	
Dimensions:	6.9" W x 8.8" H x 9" D (including pole clamp)	
Electric Classification:	Class 1, Internally Powered Equipment ^①	
Electronic Memory:	System configuration parameters stored in volatile memory are retained for at least 6 months by internal backup lithium battery. Module-specific parameters are stored for 8 hours when system is turned off. After 8 hours of continuous off-time, or if a module is detached, module-specific trend data (if applicable) and module-specific operating parameters are automatically purged. If a PCA, SpO ₂ or EtCO ₂ Module is detached and replaced with another PCA, SpO ₂ or EtCO ₂ Module, its module-specific trend data is purged.	
Environmental Conditions:	<u>Operating</u>	<u>Storage/Transport</u>
Temperature Range:	41 - 104° F (5 - 40° C)	-4 - 140° F (-20 - 60° C)
Relative Humidity: (Avoid prolonged exposure to relative humidity >85%)	20 - 90% Noncondensing	5 - 85% Noncondensing
Atmospheric Pressure:	525 - 4560 mmHg (700 - 6080 hPa)	375 - 760 mmHg (500 - 1013 hPa)
Equipment Orientation:	To ensure proper operation, Alaris® System must remain in an upright position.	
Fluid Ingress Protection:	IPX1, Drip Proof	
Mode of Operation:	Continuous	
Power Requirements:	100 - 240V ~, 50/60 Hz, 150 VA MAX ^②	
Shock Protection:	Type CF, Defibrillator Proof	
Weight:	7.2 lbs	

Specifications and Symbols (Continued)

Specifications (Continued)

NOTES:

- ① See the product-specific Section of this DFU for shock protection type and defibrillation-proof rating information.
- ② Power Cords:
North America: To ensure correct polarity and grounding reliability, use power cords that incorporate a NEMA 5-15P (125V) or NEMA 6-15P (250V) plug only.
International: Use only cords that comply with IEC 60245, or IEC 60227, designation #53 and local electrical codes and/or regulations.

Symbols

See the product-specific Section of this DFU that applies to the attached module(s) for symbols specific to that module.



Silenced alarm.



Alternating Current: Indicates device should be attached to alternating current source, 50/60 Hz only.



Battery power.



Caution: Reference accompanying documentation.



Canadian and U.S. Certification Mark: Products bearing this mark have been tested and certified in accordance with applicable U.S. and Canadian electrical safety and performance standards.



Communications connector for RS-232 attachment.



Consult operating instructions.



Type CF defibrillation-proof equipment.



Electrostatic discharge (ESD).

Specifications and Symbols (Continued)

Symbols (Continued)



Fuse Replacement: Replace fuse only with same type and rating.

IPX1

Protection against fluid ingress: Drip Proof



IUI Connector: Inter-Unit Interface connector used to establish power and communications between PC Unit and attached modules.



Main Power: Connected to alternating current, 100-240 VAC.



Manufacturing Date: Number adjacent to symbol indicates month and year of manufacture.



Potential Equalization Conductor (if so equipped). Note: If integrity of PEC or Hospital Earth System is in question, operate instrument using internal battery power.



Radio frequency (RF) transmission.

Rx Only

Caution: Federal (U.S.A.) law restricts this device to sale by or on order of a physician.



"SYSTEM ON"



Tamper Resist activate/deactivate switch.

THIS PAGE
INTENTIONALLY
LEFT BLANK

Troubleshooting and Maintenance

General

The Alaris® System Technical Service Manual is available from Cardinal Health. It includes routine service schedules, interconnect diagrams, component parts lists and descriptions, test procedures, and other technical information, to assist qualified service personnel in repair and maintenance of the instrument's repairable components. Maintenance procedures are intended to be performed only by qualified personnel, using the Service Manual and System Maintenance software.

Alarms, Errors, Messages

To enhance safety and ease of operation, the Alaris® System provides a full range of audio and visual alarms, errors, and messages.

Operating the system near equipment which radiates high-energy radio frequencies (such as, electrosurgical/cauterizing equipment, portable radios, cellular telephones) may cause false alarm conditions. If this happens, reposition the Alaris® System away from the source of interference or turn off the system and manually regulate the flow with the clamp and/or monitor the vital parameters using an appropriate clinical alternative

Definitions

See the product-specific Section of this DFU that applies to the attached module(s) for alarm, error and message definitions specific to that module.

Advisory / Message	A sequence of audio and/or visual signals indicating operating status of Alaris® System.
Alarm	An audio and visual signal that a potentially unsafe condition is present. Immediate action is required.
Alarm Silence	Alarms can be silenced for up to 120 seconds by pressing SILENCE key. Alarm indicators remain on and, if applicable, alarm silence symbol (see monitoring module Section of this DFU) is displayed. Silence period can be ended by pressing CANCEL SILENCE soft key.

Alarms, Errors, Messages (Continued)

Definitions (Continued)

Error	An audio and/or visual signal that a failure has been detected. Immediate action is required.
Maintenance Reminder	A visual message that, when enabled, appears at module startup when scheduled preventive maintenance is due/overdue for any part of Alaris® System (PC Unit or attached module).
Prompt	An audio signal and/or a visual message appearing on bottom line of Main Display or in Message Display. Audio signal may be silenced for 12 seconds by pressing SILENCE key.

Audio Characteristics

The Alaris® System provides various types of alert information. See the product-specific Section of this DFU that applies to the attached module(s) for audio characteristics specific to that module.

Type	Sound	Notes
Advisory / Message	One short beep every 2 seconds	Variable volume; can be silenced for 2 minutes.
Alarm	Choice of 3 alarm audio profiles, selectable in System Configuration	Variable volume; can be silenced for 2 minutes.
Error (Hardware Detected)	Pairs of long beeps	Fixed maximum decibel volume; cannot be silenced.
Error (Software Detected)	Pairs of long beeps	Fixed maximum decibel volume; can be silenced for 2 minutes.
Illegal Key Press	Two short beeps	Variable volume; cannot be silenced.
Key Click	One short beep	Fixed minimum volume; can be silenced and disabled in System Configuration.
Prompt	One short beep every 2 seconds	Variable volume; can be silenced.

Alarms, Errors, Messages (Continued)

Alarms

Alarm	Meaning	Response
Battery Discharged	Operation of all modules stopped due to insufficient battery charge.	Connect AC power cord to power source (alarm silenced). To continue operation of paused modules, press RESTART key on affected module.
Channel Disconnected	Module(s) disconnected while in operation or have a communication problem.	To silence alarm and clear message from screen, press CONFIRM soft key. Reattach module, if needed, ensuring it is securely "clicked" into place at Module Release Latch. If alarm is still present, replace module with an operational instrument.
Very Low Battery <5 minutes to system shutdown	Battery has 5 minutes or less of power at current power consumption rate before operation stops.	Connect AC power cord to power source (alarm silenced).

Errors

Error	Meaning	Response
Audio System Error	Main speaker failure.	<ol style="list-style-type: none"> 1. Visually check alarm status to determine whether or not an operational alarm also needs to be addressed (red Alarm Status Indicator lit). 2. Replace PC Unit with an operational instrument.
Channel Error	Error detected. Operation stops on affected module.	To silence alarm and continue operation of unaffected modules, press CONFIRM soft key. Replace module with an operational instrument.
Defective Battery	Defective battery.	To continue temporary operation, press SILENCE key. Replace PC Unit with an operational instrument.

Alarms, Errors, Messages (Continued)

Errors (Continued)

Error	Meaning	Response
Hardware Detected Error	Error detected on PC Unit. Operation stops on all modules.	Replace PC Unit with an operational instrument.
Missing Battery	Battery not present or not connected.	To continue temporary operation, press SILENCE key. Replace PC Unit with an operational instrument.
Power Supply Error	Power supply system malfunction.	Disconnect AC power immediately. To continue operation under battery power, press SILENCE key. Replace PC Unit with an operational instrument.
System Error	Error detected on PC Unit. Operation continues on all attached modules.	To continue temporary operation, press SILENCE key. Replace PC Unit with an operational instrument.

Messages

Message	Meaning	Response
Battery Run Time = X.X hours	AC power cord is disconnected from power source. Approximate remaining battery run time under current power consumption rate is displayed.	Connect AC power cord to power source as soon as possible.
Low Battery	Low battery threshold sensed; remaining battery run time is limited.	Connect AC power cord to power source (alarm silenced).
Panel Locked	Tamper Resist feature is active and key was pressed.	If appropriate, deactivate Tamper Resist feature using Tamper Resist Control on back of PC Unit.
Panel Unlocked	Tamper Resist feature deactivated.	None.
Powering Down	Last module powering off. System shuts off in indicated number of seconds.	Press any key, except SYSTEM ON key, to cancel power down sequence.

Alarms, Errors, Messages (Continued)

Messages (Continued)

Message	Meaning	Response
Replace Battery	Occurs at System On. Battery has less than 50% of original capacity.	To continue normal operation with reduced battery capacity, press CONFIRM soft key. Replace PC Unit with an operational instrument.

Storage

Plug the PC Unit into an AC outlet during storage to ensure a fully charged battery. The AC indicator light (⏻) is on when the PC Unit is plugged in.

Battery Care and Maintenance

Battery Type and Charging

The PC Unit is equipped with a 12 volt, 4000 mAh nickel metal hydride battery. The battery is charging whenever the instrument is plugged into an AC receptacle. The life expectancy of the battery is dependent on the amount of use, the depth of discharge, and the state of the charge that is maintained. Generally, the battery has the longest life if the instrument is plugged in and battery use is infrequent. Frequent use of battery power and insufficient battery charge cycles significantly decrease the life of the battery.

The quality of the battery is also a significant factor in determining battery life and runtime. The battery cannot be repaired and should not be opened. Replace the battery with the same type, size and voltage rating. Use of any other brand may yield poor performance and is not recommended.

Batteries should be charged in a room with a temperature between 50 - 80.6° F (10 - 27° C), to minimize charge time and maximize battery life.

Battery Care and Maintenance (Continued)

Battery Charge

- The PC Unit is shipped with the battery in a discharged condition.
- Before the PC Unit is released for use, it should be plugged into a hospital grade AC outlet and the battery charged for at least 8 hours. This ensures proper battery operation when the Alaris® System is first set up for patient use.
- Whenever possible, leave the power cord connected to an external AC power source while operating the instrument.

Battery Care

The battery capacity should be checked at least once every 6 months. Reference the Alaris® System Technical Service Manual for test and replacement procedures.

If the PC Unit is to be stored at temperatures in excess of 86° F (30° C) for 1 or more months, the battery should be removed and placed in an environment of 50 - 86° F (10 - 30° C).

If the batteries are to be stored for more than 1 year, they should be charged at least once per year to prevent leakage and deterioration in performance due to self-discharge.

When the battery is first being put into use, or has been out of use for 1 or more months, it will not have full capacity due to deactivation of reactants.

Restore such batteries to original performance by repeating 1 or 2 cycles of fully charging and fully discharging.

Some temporary reduction in capacity might become apparent if the battery is partially discharged repeatedly. Doing 1 or 2 cycles of full discharge and full charge can restore full performance.

Battery Cautions and Disposal

Battery replacement should be performed by qualified service personnel while the instrument is not in use.

CAUTION

Do not open, incinerate or short circuit. Worn-out batteries must be disposed of properly, according to local regulations.

Inspection Requirements

To ensure the Alaris® System remains in good operating condition, both regular and preventive maintenance inspections are required. Reference the System Maintenance software for detailed instructions.

REGULAR INSPECTIONS

<u>PROCEDURE</u>	<u>FREQUENCY</u>
INSPECT FOR DAMAGE:	
Exterior Surface	Each usage
Pole Clamp	Each usage
Power Cord	Each usage
Keypad	Each usage
CLEANING	As required
Start-Up	Each usage

WARNING

Failure to perform these inspections may result in improper instrument operation.

CAUTION

Regular and preventive maintenance inspections should only be performed by qualified service personnel.

Alaris® Pump Module, Model 8100
Alaris® Syringe Module, Model 8110

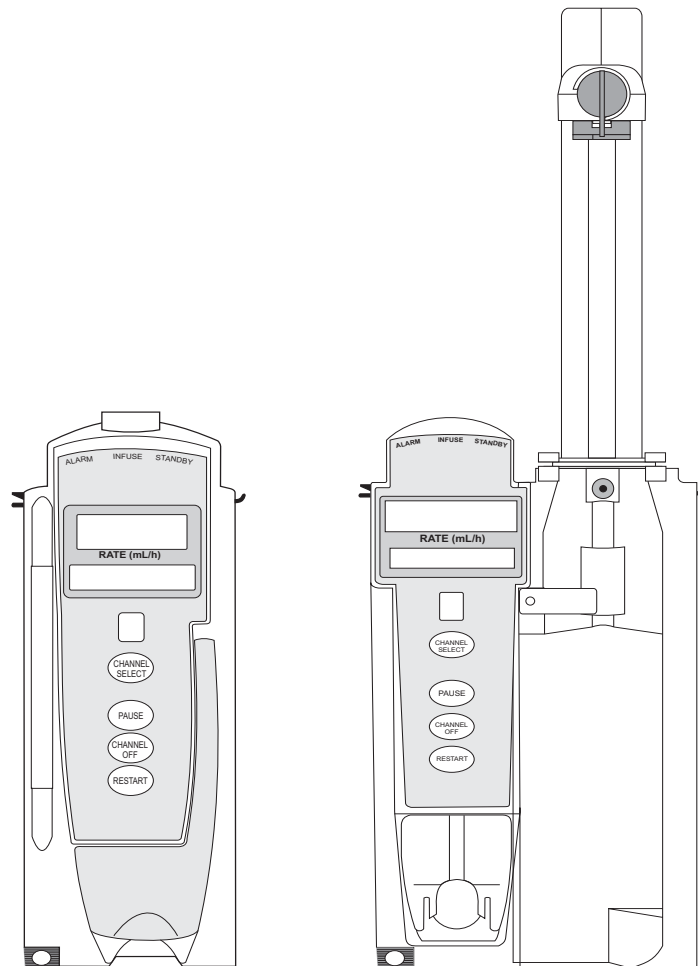

GETTING STARTED

INTRODUCTION.....	2-1
PREPARING ADMINISTRATION SET (PUMP MODULE).....	2-3
Loading.....	2-3
Removing.....	2-5
Priming.....	2-5
PREPARING SYRINGE AND ADMINISTRATION SET (SYRINGE MODULE).....	2-6
Loading.....	2-7
Priming - Using Options Menu.....	2-11
Priming - Manual.....	2-17

PROGRAMMING

PRIMARY INFUSION - WITH GUARDRAILS® SUITE MX PROTECTION.....	2-21
Continuous Infusion.....	2-23
Bolus Dose.....	2-30
Intermittent Infusion.....	2-35
IV Fluid Infusion.....	2-39
SECONDARY INFUSION - WITH GUARDRAILS® SUITE MX PROTECTION (PUMP MODULE).....	2-44
Introduction.....	2-44
Setup.....	2-45
Infusion.....	2-46
Stopping Secondary and Returning to Primary.....	2-49
INFUSION - NO GUARDRAILS® SUITE MX PROTECTION.....	2-50
Basic Infusion.....	2-51
Promoting Basic Infusion to Guardrails® Suite MX Protection.....	2-52
Continuous Infusion - Drug Calculation.....	2-52
Bolus Dose.....	2-54
SECONDARY INFUSION - NO GUARDRAILS® SUITE MX PROTECTION (PUMP MODULE).....	2-55
Introduction and Setup.....	2-55
Infusion.....	2-55
Stopping Secondary and Returning to Primary.....	2-56
PAUSING, CHANGING, RESTARTING INFUSION.....	2-57
Pausing and Restarting Infusion.....	2-57
Changing Rate or VTBI During Infusion.....	2-57
Restoring Infusion.....	2-58
VIEWING AND CLEARING VOLUME INFUSED.....	2-58
CHANNEL LABELS.....	2-60
Selecting.....	2-60
Removing.....	2-62
ANESTHESIA MODE.....	2-62
DELAY OPTIONS.....	2-63
Delaying Infusion.....	2-63
Scheduling a Callback.....	2-66
Pausing Infusion.....	2-67
MULTIDOSE MODE.....	2-68
Volume/Duration Enabled.....	2-70
Volume/Duration Disabled.....	2-71
SELECTING PRESSURE LIMIT.....	2-73
Pump Module.....	2-73
Syringe Module.....	2-74

GENERAL SETUP AND OPERATION

SYSTEM START-UP / SETUP.....	2-77
Setting Up for Gravity Infusion (Pump Module).....	2-77
Changing Solution Container (Pump Module).....	2-77
Changing Syringe During Infusion (Syringe Module).....	2-78

GENERAL INFORMATION

WARNINGS AND CAUTIONS.....	2-79
General.....	2-79
Administration Sets.....	2-79
Epidural Administration.....	2-81
Guardrails® Suite MX.....	2-82
ADMINISTRATION SET / SYRINGE INFORMATION.....	2-82
SmartSite® Infusion Set (Pump Module).....	2-83
Safety Clamp Fitment (Pump Module).....	2-84
Compatible Syringes (Syringe Module).....	2-85
FEATURES AND DISPLAYS.....	2-86
Features and Definitions.....	2-86
Operating Features, Controls, Indicators.....	2-93
Displays.....	2-96
DRUG CALCULATION DEFINITIONS AND FORMULAS.....	2-97
CONFIGURABLE SETTINGS.....	2-98
Shared Infusion.....	2-98
Pump Module.....	2-99
Syringe Module.....	2-100
SPECIFICATIONS.....	2-101
Pump Module.....	2-101
Syringe Module.....	2-103
SYMBOLS.....	2-107
Pump and Syringe Modules.....	2-107
Pump Module.....	2-107
TRUMPET AND START-UP CURVES.....	2-108
Introduction.....	2-108
Graphs.....	2-111

TROUBLESHOOTING AND MAINTENANCE

GENERAL.....	2-115
ALARMS, ERRORS, MESSAGES.....	2-115
Definitions.....	2-116
Audio Characteristics.....	2-116
Alarms.....	2-116
Errors.....	2-121
Messages.....	2-122
Possible End of Infusion Messages and Alerts.....	2-124
INSPECTION REQUIREMENTS.....	2-124

Introduction

This Section of the DFU provides Pump Module (Model 8100) and Syringe Module (Model 8110) instructions and information. It is used in conjunction with:

- Alaris® product administration set instructions
- Drug product labeling
- PC Unit Section of this DFU
- Pump Module Set Compatibility Card
- Pump Module Technical Service Manual
- Syringe Module Set Compatibility Card
- Syringe Module Technical Service Manual
- System Maintenance software (and its instructions) for Alaris® System check-in, maintenance, and wireless configuration

The Pump and Syringe Modules are intended for facilities that utilize infusion and/or syringe pumps for the delivery of fluids, medications, blood, and blood products using continuous or intermittent delivery through clinically acceptable routes of administration; such as, intravenous (IV), intra-arterial (IA), subcutaneous, epidural, enteral, or irrigation of fluid spaces. The Pump and Syringe Modules are indicated for use on adults, pediatrics, and neonates. Up to four (4) Pump and/or Syringe Modules can be connected to the Alaris® System.

If a procedure/information applies to a specific module, the following identifiers indicate the applicable module.

Pump Module :



Syringe Module:

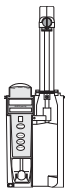

Administration Sets / Syringes: See "General Information" for specific "Administration Set / Syringe Information".

Alarms, Errors, Messages: See "Troubleshooting and Maintenance" for module-specific alarms, errors and messages.

WARNING

Read all instructions, for both the infusion modules and PC Unit, before using the Alaris® System.

CAUTION

Rx Only

Introduction (Continued)

Contraindications: None known.

Electromagnetic Environment: See "Appendix" Section of this DFU ("Regulations and Standards", "Compliance").

Preparing Administration Set (Pump Module)



For instructions on how to go from checking in a Pump Module to preparing it for an infusion setup, see "General Setup and Operation".

Loading

1. If a new set is being loaded, prime set (see "Priming" procedure).
2. Open Pump Module door.
3. Load administration set, as follows:
 - a. Hold upper fitment above fitment recess and lower into recess.
 - b. Ensure tubing is not twisted.

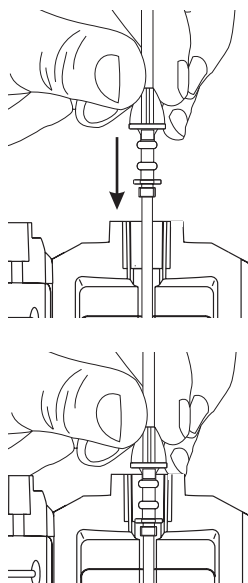

WARNINGS

- To prevent a **potential free-flow condition**, ensure no extraneous object (for example, bedding, tubing, glove) is enclosed or caught in the Pump Module door.
- **Administration Sets:**
 - ♦ Use only **Pump Module/ Gemini Infusion System administration sets**. The use of any other set may cause improper instrument operation, resulting in an inaccurate fluid delivery or other potential hazard. For a list of compatible sets, reference the Set Compatibility Card (provided separately).
 - ♦ **Discard if** packaging is not intact or protector caps are unattached.

CAUTIONS

- Before operating instrument, verify that administration set is **free from kinks and installed correctly** in instrument.
- Insert upper fitment **before installing safety clamp* fitment**.
- When **reloading an administration set**, leave the safety clamp* fitment in the **closed** position (see "General Information", "Safety Clamp Fitment").
- * "Safety clamp" is referred to on the device as "Flo-Stop".

Preparing Administration Set (Pump Module) (Continued)



Loading (Continued)

- c. Press safety clamp fitment into recess below mechanism. ①
- d. Using a finger tip, firmly push tubing toward back of Air-in-Line (AIL) Detector.

CAUTION

To reduce the potential for nuisance AIL alarms, **ensure tubing is fully inserted** in AIL Detector.

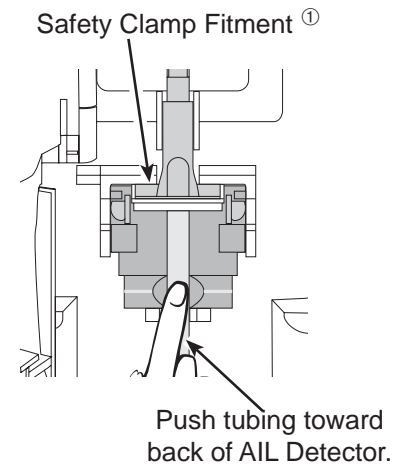

4. Close door and latch, as follows:
 - a. Close door and hold in a closed position by grasping door and instrument case with one hand.
 - b. Gently lower latch.
 - Safety clamp device is automatically disengaged. ①

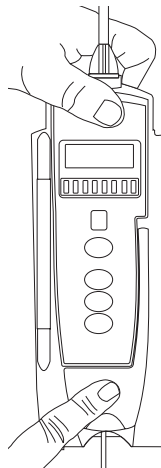

WARNINGS

- **Do not touch** the administration set while closing the door. Failure to follow this instruction may result in infusion rate inaccuracy.
- To **prevent a potential free-flow condition**, ensure no extraneous object (for example, bedding, tubing, glove) is enclosed or caught in the Pump Module door.

5. Open roller clamp.
6. Verify no fluid is flowing through drip chamber.

NOTE:

① "Safety clamp" is referred to on the device as "Flo-Stop".

Preparing Administration Set (Pump Module) (Continued)



Removing

1. Close roller clamp.
2. Open Pump Module door.
 - Set's safety clamp fitment automatically closes to prevent accidental free-flow. ①
3. Remove set, as follows:
 - a. Gently pull tubing below Air-in-Line Detector forward and out.
 - b. Lift upper fitment from upper fitment receptacle.
4. If set is being removed to begin a gravity flow:
 - a. Depress blue ridged release tab on upper side of safety clamp device. ①
 - b. Slide white slide clamp into blue fitment (open position).
 - c. Adjust flow rate using set's roller clamp.

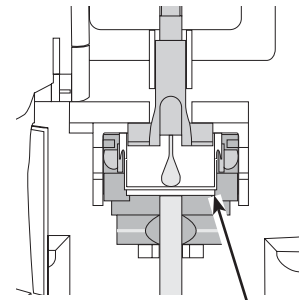

White Slide Clamp
(shown in closed position)

NOTE:

① "Safety clamp" is referred to on the device as "Flo-Stop".

Priming

1. Prepare primary solution container in accordance with manufacturer's directions for use.
2. Open administration set package, remove set, and close roller clamp. (Reference set's directions for use.)
3. Insert administration set spike into prepared fluid container, following accepted hospital/facility procedure, and hang container 20 inches above Pump Module.

Preparing Administration Set (Pump Module) (Continued)



Priming (Continued)

4. Fill drip chamber to 2/3 full.
5. If container requires venting, open vent cap on administration set spike.
6. To prime tubing and clear air from injection sites and tubing fittings, slowly open roller clamp.
7. When priming is complete, close roller clamp.
8. Verify no fluid flow.

Preparing Syringe and Administration Set (Syringe Module)



To decrease start-up delays when infusing at a rate less than 1.0 mL/h, the following actions are recommended:

- Enable Fast Start (with Data Set development of System Configuration per profile).
- Use smallest syringe size possible (for example, if infusing 7.2 mL of fluid, use a 10 mL syringe).
- Prime Syringe Module as well as administration set (see "Priming - Using Options Menu").

For instructions on how to go from checking in a Syringe Module to preparing it for an infusion setup, including how to change a syringe during infusion, see "General Setup and Operation".

1. Prepare syringe (see "General Information", "Compatible Syringes") in accordance with manufacturer's directions for use.
2. Prepare administration set (reference Set Compatibility Card, provided separately) in accordance with manufacturer's directions for use.
3. Attach upper fitting of administration set to syringe tip.

WARNING

Use only standard, single-use, disposable syringes (with luer-lock connectors) and administration sets, designed for use on syringe pumps. The use of any other **syringe or administration set** may cause improper instrument operation, resulting in inaccurate fluid delivery or pressure sensing, or other potential hazards. For a list of compatible syringes, see "General Information", "Compatible Syringes". For a list of compatible administration sets, reference the Set Compatibility Card (provided separately).

Preparing Syringe and Administration Set (Syringe Module) (Continued)



Loading

WARNINGS

- **Before loading** the syringe, check it for damage or defects.
- Ensure syringe barrel, flange, and plunger are installed and secured correctly. Failure to **install syringe correctly** can result in uncontrolled fluid flow to the patient, and may cause serious injury or death.
- **Before loading or unloading** the syringe, always turn off fluid flow to the patient, using the tubing clamp or stopcock. Uncontrolled fluid flow can occur when the administration set is not clamped or turned off, and may cause serious injury or death.

CAUTION

When initially loading the syringe, allow for the volume of fluid contained in the administration set and retained in the syringe at the end of an infusion, as this "dead space" will not be infused.

1. Ensure instrument is as close to level of patient as possible (patient should be in line with **CHANNEL SELECT** key).

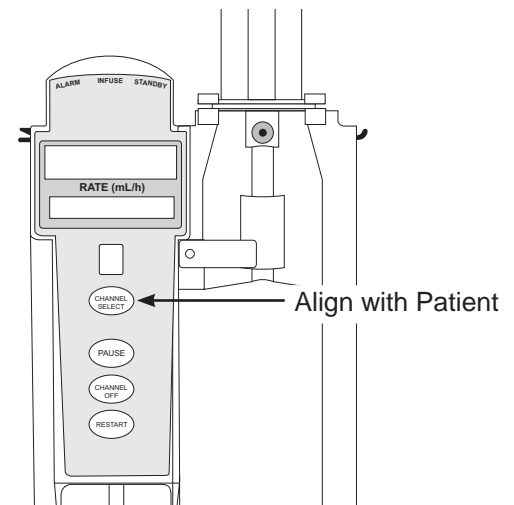

Preparing Syringe and Administration Set (Syringe Module) (Continued)



Loading (Continued)

2. Open syringe barrel clamp.
 - a. Pull syringe barrel clamp out and hold.
 - b. Rotate clamp to left (clockwise or counter clockwise) until it clears syringe chamber.
 - c. Gently release clamp.

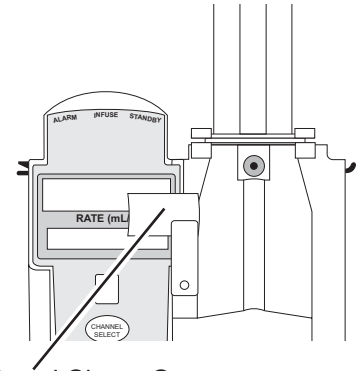

Syringe Barrel Clamp Open

3. Raise drive head to its fully extended position.
 - a. Twist gripper control clockwise and hold in position. ①
 - b. While holding gripper control in open position, raise drive head to full extension.
 - c. Gently release gripper control.

Drive Head Fully Extended

Gripper Control / Drive Head Release in Open Position

Plunger Grippers Open

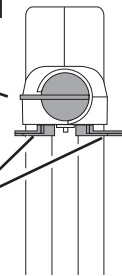

4. Insert syringe (from front of instrument) by sliding flat edge of syringe barrel flange between barrel flange grippers.

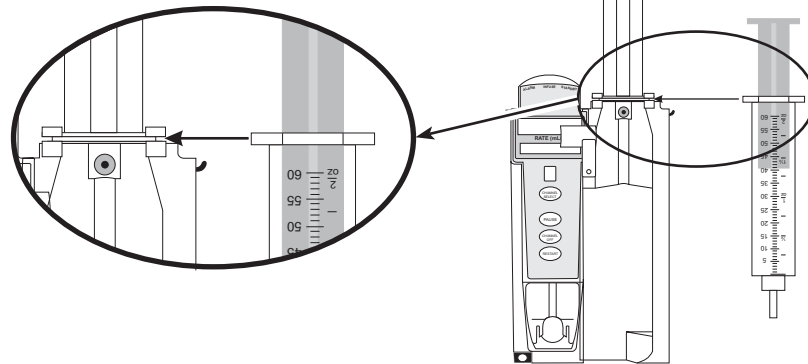

Preparing Syringe and Administration Set (Syringe Module) (Continued)



Loading (Continued)

5. Lock syringe in place.
 - a. Pull syringe barrel clamp out and hold.
 - b. Rotate clamp to right (clockwise or counter clockwise) until it lines up with syringe.
 - c. Gently release clamp against syringe.

6. Lower drive head and lock plunger in place with plunger grippers.
 - a. Twist gripper control clockwise and hold in position. ①
 - b. While holding gripper control in open position, gently lower drive head until it makes contact with plunger flange.
 - c. Gently release gripper control.
 - d. Ensure plunger grippers lock and hold plunger in place.

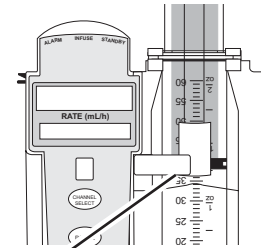

Syringe Barrel Clamp Closed

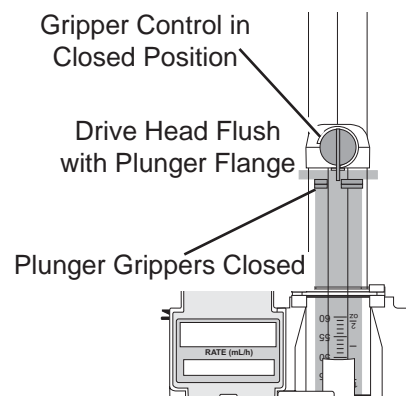

CAUTIONS

- To **avoid an occlusion** when loading a smaller size syringe, use extra care to close off administration set tubing and gently lower drive head against syringe plunger.
- For **smaller syringes** (such as; 1, 3 or 5 mL), stabilize the syringe plunger with thumb and index finger while carefully lowering the drive head. Ensure the syringe plunger head makes contact with the small black sensor, located on the bottom of the drive head (between the plunger grippers).

Preparing Syringe and Administration Set (Syringe Module) (Continued)



Loading (Continued)

7. Insert pressure sensing disc (if used), as follows: ②

WARNING

When the **pressure sensing disc is not being used** and an occlusion occurs, there is a risk of infusing pressurized buildup of infusates upon correction of the occlusion. To avoid an inadvertent bolus, relieve the pressure before restarting the infusion.

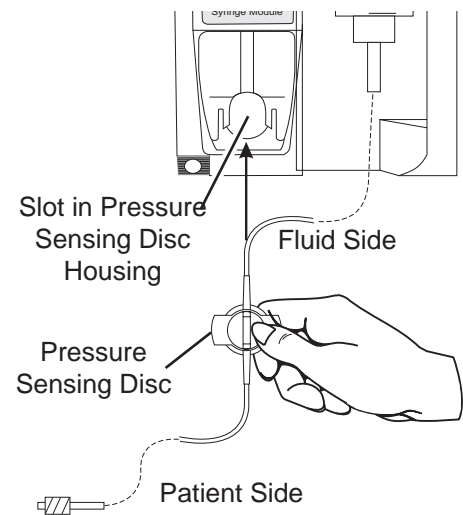

- a. Orient pressure sensing disc, as follows:
 - fluid side up (patient side down)
 - cavity forward (membrane toward instrument)
- b. Gently slide pressure sensing disc up into slot in pressure sensing disc housing.

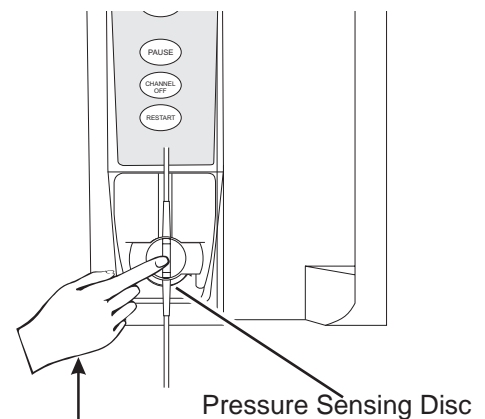

Preparing Syringe and Administration Set (Syringe Module) (Continued)



Loading (Continued)

- c. Apply firm upward pressure on pressure sensing disc (not tubing) until disc snaps into place.

NOTES:

- ① The gripper control is spring loaded. When twisted to the open position and then released, it (and the plunger grippers) returns to the closed position.
- ② The following Syringe Module features are available only with extension sets fitted with a pressure sensing disc: (See "General Information", "Features and Displays" for definitions.)
 - Auto Pressure
 - Back Off (upon occlusion)
 - Customizable Pressure Alarm Settings (see "Occlusion Pressure" feature definition)
 - Dynamic Pressure Display (see "Pressure Tracking" feature definition)
 - Fast Start

Priming - Using Options Menu

The Priming option can be enabled at the time the Alaris® System is configured for use. The Priming selection (**PRIME** soft key) is available only after the syringe and infusion type have been selected, and prior to beginning an infusion.

If a pressure sensing disc is in use, it should be removed from the instrument before priming. See the applicable procedure (as follows) depending on whether or not a pressure sensing disc is used. ①

WARNING

When priming:

- Ensure administration set is not connected to patient.
- Ensure air is expelled from line prior to beginning infusion (unexpelled air in line could have serious consequences).

Failure to prime correctly can delay infusion delivery and cause the total volume to be infused to read higher than the actual total delivered to the patient.

CAUTION

During priming, the pressure limit alarms are temporarily increased to their maximum level.

Preparing Syringe and Administration Set (Syringe Module) (Continued)



Priming - Using Options Menu (continued)

Administration Set With Pressure Sensing Disc

1. Ensure administration set is not connected to patient.
2. If installed, remove pressure sensing disc from instrument.
 - Using a finger, apply firm downward pressure on pressure sensing disc (not tubing) until disc snaps loose from slot in pressure sensing disc housing.

CAUTION

The pressure sensing disc, if left installed during priming, can trap air that may not be totally expelled. To **ensure entrapped air is eliminated**, it is recommended that the pressure sensing disc be removed prior to priming and the membrane gently massaged with a finger while priming. After priming is completed, reinstall the pressure sensing disc.

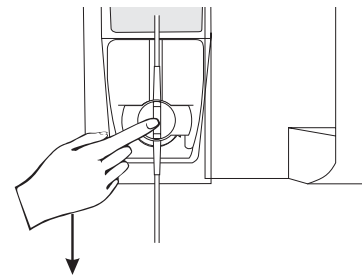

3. Press **OPTIONS** key.

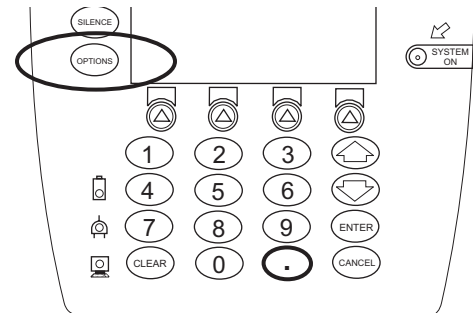

Preparing Syringe and Administration Set (Syringe Module) (Continued)



Priming - Using Options Menu (continued)

Administration Set With Pressure Sensing Disc (Continued)

4. Press **Prime Set with Syringe** soft key.

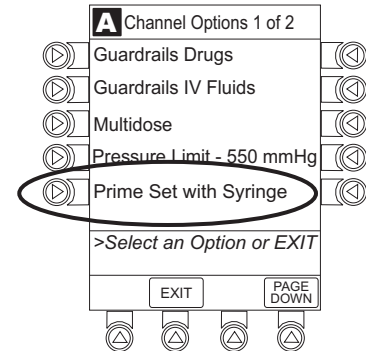

- If pressure sensing disc was not removed prior to pressing **Prime Set with Syringe** soft key, a pressure sensing disc removal prompt displays.

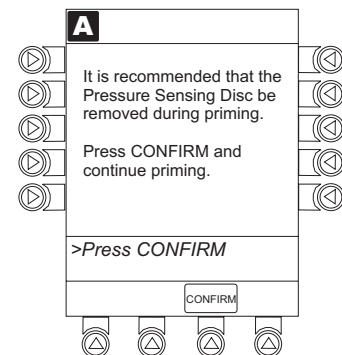

5. Invert pressure sensing disc so that patient side is up.
6. Hold pressure sensing disc between 2 fingers.

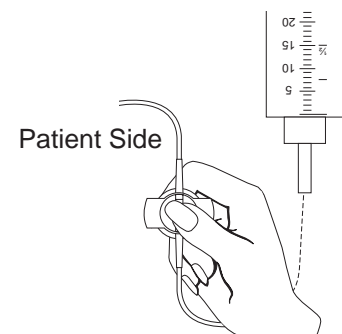

Preparing Syringe and Administration Set (Syringe Module) (Continued)



Priming - Using Options Menu (continued)

Administration Set With Pressure Sensing Disc (Continued)

7. Press and hold **PRIME** soft key. ^②

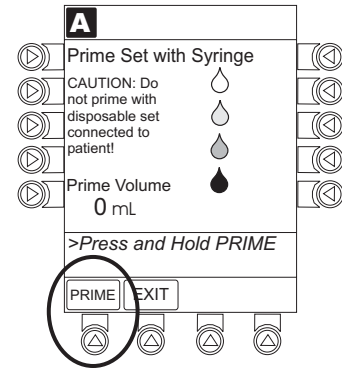

8. Gently massage pressure sensing disc to ensure all air is expelled. Disc must remain inverted only until air is expelled. Continue to gently massage disc throughout priming to ensure it does not become under- or over-filled.
9. Continue to prime until fluid flows and priming is complete.
10. When priming is complete, release pressure sensing disc and **PRIME** soft key. ^③

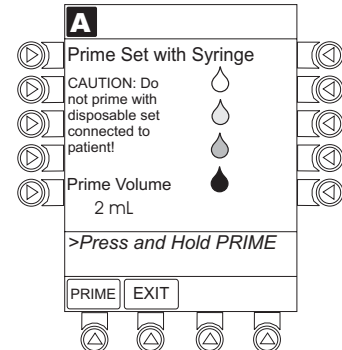

Preparing Syringe and Administration Set (Syringe Module) (Continued)



Priming - Using Options Menu (continued)

Administration Set With Pressure Sensing Disc (Continued)

11. Reinstall pressure sensing disc, as follows:
 - a. Orient pressure sensing disc, as follows:
 - fluid side up (patient side down)
 - cavity forward (membrane toward instrument)
 - b. Gently slide pressure sensing disc up into slot in pressure sensing disc housing.
 - c. Apply firm upward pressure on pressure sensing disc (not tubing) until disc snaps into place.

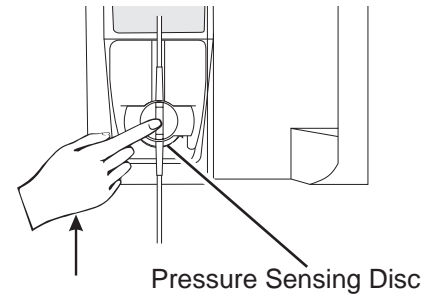
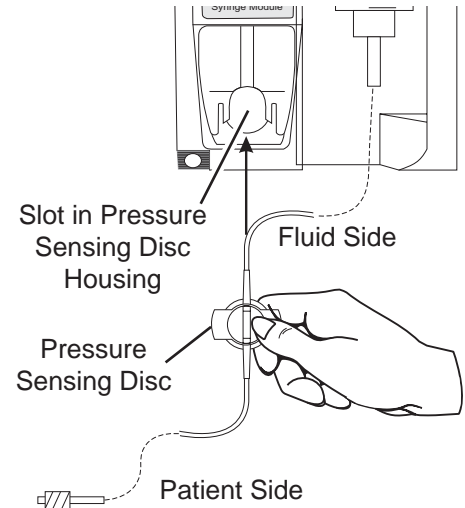

12. To return to main screen, press **EXIT** soft key.
 - If **EXIT** soft key is pressed before pressure sensing disc is reinstalled, a prompt to reinstall pressure sensing disc displays.

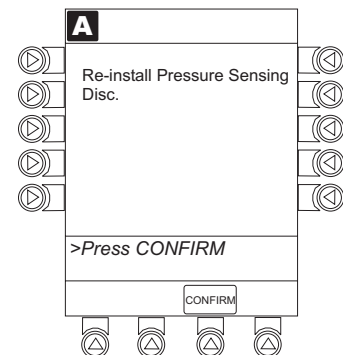

Preparing Syringe and Administration Set (Syringe Module) (Continued)



Priming - Using Options Menu (continued)

Administration Set With No Pressure Sensing Disc

1. Press **OPTIONS** key.
2. Press **Prime Set with Syringe** soft key.

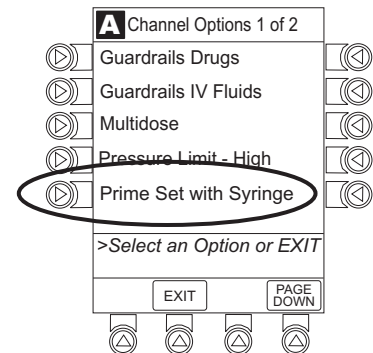

3. Press and hold **PRIME** soft key until fluid flows and priming is complete. ^②
4. Release **PRIME** soft key. ^③
5. To return to main screen, press **EXIT** soft key.

NOTES:

- ① When manually priming (per hospital/facility protocol) and an administration set having a pressure sensing disc is in use, depress the disc between 2 fingers while priming and prime uphill (distal end of pressure sensing disc/tubing pointing upward).
- ② Fluid is delivered during priming only while the **PRIME** soft key is pressed. Each press of the **PRIME** soft key delivers up to 2 mL of priming fluid per continuous press. To deliver additional amounts, press the **PRIME** soft key again.
- ③ Volume used during priming is displayed but not added to VTBI or VI.

Preparing Syringe and Administration Set (Syringe Module) (Continued)



Priming - Manual

Use the following procedures to manually prime the administration set.

WARNING

When priming:

- Ensure administration set is not connected to patient.
- Ensure air is expelled from line prior to beginning infusion (unexpelled air in line could have serious consequences).

Failure to prime correctly can delay infusion delivery and cause the total volume to be infused to read higher than the actual total delivered to the patient.

Administration Set With Pressure Sensing Disc

1. Ensure administration set is not connected to patient.
2. If installed, remove pressure sensing disc from instrument.
 - Using a finger, apply firm downward pressure on pressure sensing disc (not tubing) until disc snaps loose from slot in pressure sensing disc housing.

CAUTION

The pressure sensing disc, if left installed during priming, can trap air that may not be totally expelled. To **ensure entrapped air is eliminated**, it is recommended that the pressure sensing disc be removed prior to priming and the membrane gently massaged with a finger while priming. After priming is completed, reinstall the pressure sensing disc.

Preparing Syringe and Administration Set (Syringe Module) (Continued)



Priming - Manual (Continued)

Administration Set With Pressure Sensing Disc (Continued)

3. Invert pressure sensing disc so that patient side is up.
4. Hold pressure sensing disc between 2 fingers.

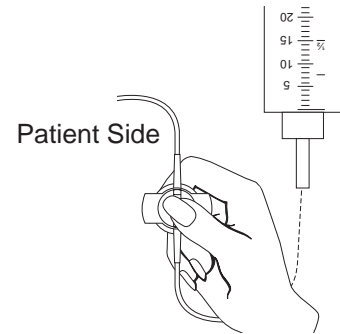

5. Slowly prime set while gently massaging pressure sensing disc to ensure all air is expelled. Disc must remain inverted only until air is expelled. Continue to gently massage disc throughout priming to ensure it does not become under- or over-filled.
6. When priming is complete (no air exists), close set clamp.

Administration Set With No Pressure Sensing Disc

1. Prime per hospital protocol.
2. When priming is complete (no air exists), close set clamp.

Eliminate Mechanical Slack

To eliminate mechanical slack or free play, and minimize delays in the delivery of medication, especially when infusing at a rate lower than 1.0 mL/h, it is recommended that the instrument be primed per the following procedure.

1. Load syringe (see "Loading" procedure). If a pressure sensing disc is being used, do not install disc until priming is complete.
2. Select syringe and infusion type (see "Programming" chapter).

Preparing Syringe and Administration Set (Syringe Module) (Continued)



Priming - Manual (Continued)

Eliminate Mechanical Slack (Continued)

3. Open administration set clamp.
4. Prime, as follows, using Priming option (see "Priming - Using Options Menu"):
 - a. Follow applicable procedure (based on whether or not pressure sensing disc is installed) through step to press and hold **PRIME** soft key.
 - b. Prime until fluid drips from end of tubing.
 - c. Complete procedure (installing pressure sensing disc, if applicable, and exiting options menu).

THIS PAGE
INTENTIONALLY
LEFT BLANK

References throughout this procedure to specific drugs and drug doses are for illustration purposes only. Reference specific drug product labeling for information concerning appropriate administration techniques and dosages.

See "General Information", "Features and Displays" and the PC Unit Section of this DFU for information about:

- Displays
- Operating Features, Controls, Indicators

The majority of user interface programming is identical for both the Pump Module and Syringe Module. When referring to both modules, the term "infusion modules" is used.

Primary Infusion - With Guardrails® Suite MX Protection

The following procedures are to be used only when the drug to be infused is listed in the Drug Library. To access the Drug Library, a hospital-defined best-practice Data Set must be transferred using the Editor Software and the Profiles feature must be enabled.

1. Perform following steps (see PC Unit Section of this DFU, "General Setup and Operation", "Start-Up"):
 - a. Power on system.
 - b. Choose **Yes** or **No to New Patient?**
 - c. Confirm current profile or select a new profile.
 - d. Enter patient identifier, if required.
2. Prepare and load syringe/administration set (see "Getting Started").
3. Prime (see "Getting Started").

WARNING

When the **pressure sensing disc is not being used** and an occlusion occurs, there is a risk of infusing pressurized buildup of infusates upon correction of the occlusion. To avoid an inadvertent bolus, relieve the pressure before restarting the infusion.

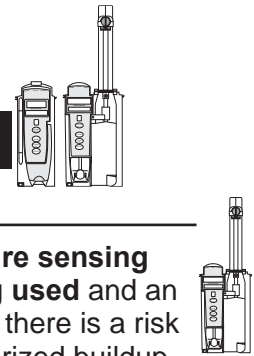

Primary Infusion - With Guardrails® Suite MX Protection (Continued)

4. Press **CHANNEL SELECT** key.

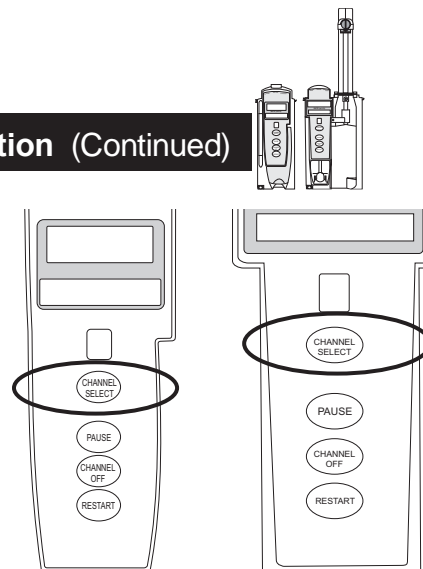

5. Syringe Module: Select syringe type and size, as follows; otherwise, proceed to step 6. ①

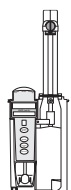

WARNING

Ensure the displayed **syringe manufacturer and syringe size** correctly identify the installed syringe. Mismatches may cause an under-infusion or over-infusion to the patient that could result in serious injury and/or death. For a list of compatible syringes, see "General Information", "Compatible Syringes". If the installed syringe is displayed and selected, but is not recognized, servicing is required (see "Maintenance", "Service Information" in "Appendix" Section of this DFU).

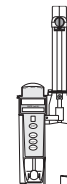

- a. Press soft key next to installed syringe type and size. If a default syringe list has been enabled and correct syringe cannot be found, press **ALL SYRINGES** soft key.

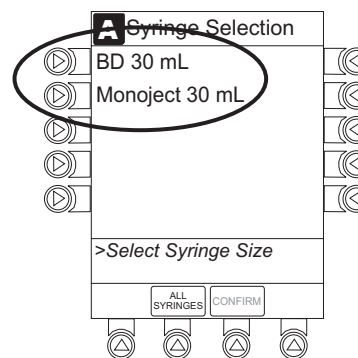

Primary Infusion - With Guardrails® Suite MX Protection (Continued)

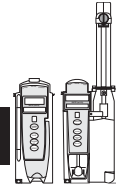

- b. To accept, press **CONFIRM** soft key.

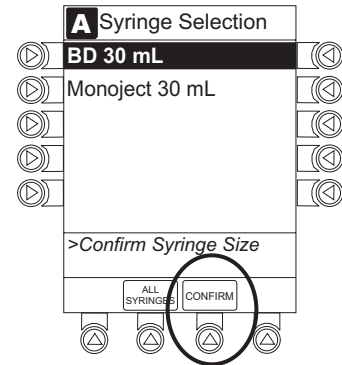

6. Start applicable infusion, as described in following procedures:

Continuous Infusion
Bolus Dose
Intermittent Infusion
IV Fluid Infusion

NOTE:

- ① At the start of a Syringe Module infusion program, the system prompts to select and confirm the syringe type and size. The system automatically detects the syringe size, and lists syringe types and sizes that most closely match the installed syringe. If the syringe is not recognized, **Syringe not recognized** displays.

Continuous Infusion

When using a drug listed in the Drug Library, the drug parameters are automatically calculated, based on:

- drug selected
- weight entry (if required)
- rate or dose entry
- VTBI entry (Syringe Module: if other than All)

Primary Infusion - With Guardrails® Suite MX Protection (Continued)

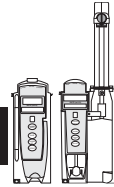

Continuous Infusion (Continued)

1. Press **Guardrails Drugs** soft key.

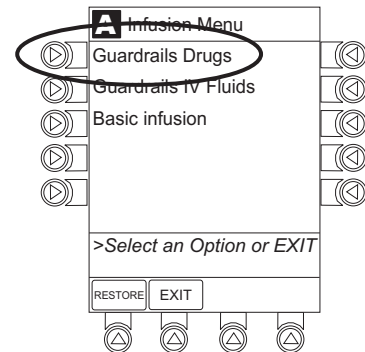

2. Press soft key next to desired drug. ^①

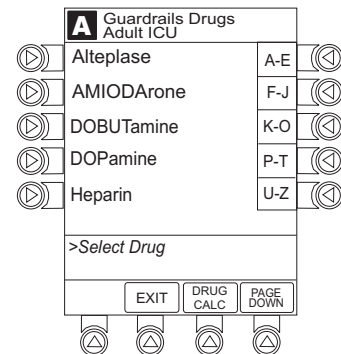

- If applicable, an optional hospital-defined therapy or clinical indication for delivery of this infusion may appear (as in illustrated example, which reflects use of Alteplase). Different limits can be defined for same drug with different therapeutic indications.

Therapy indication appears on drug or IV fluid confirmation screen. Once drug or IV fluid has been confirmed, therapy indication appears in title bar.

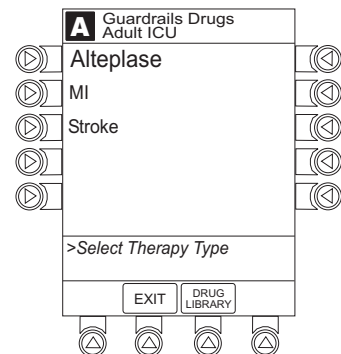

-- Continued on Next Page --

Primary Infusion - With Guardrails® Suite MX Protection (Continued)

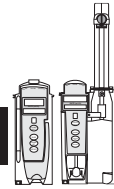

Continuous Infusion (Continued)

- If applicable, a weight-based or non weight-based option for delivery of this infusion may appear (as in illustrated example, which reflects use of Heparin).

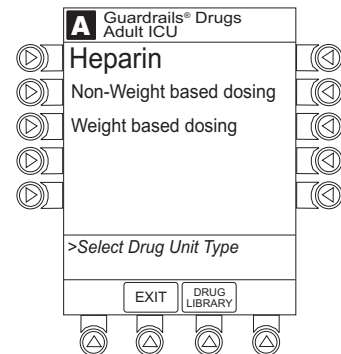

- If applicable, multiple concentration listings for delivery of this infusion may appear (as in illustrated example, which reflects use of Dopamine).

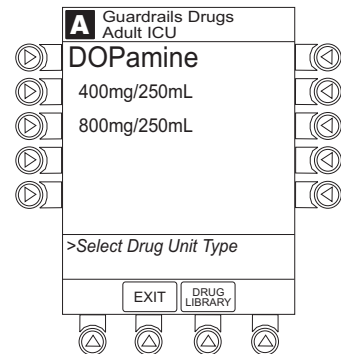

3. To continue programming, press **Yes** soft key. ②

- Bolus dose units appear if Bolus Dose is enabled.

OR

To change selection, press **No** soft key.

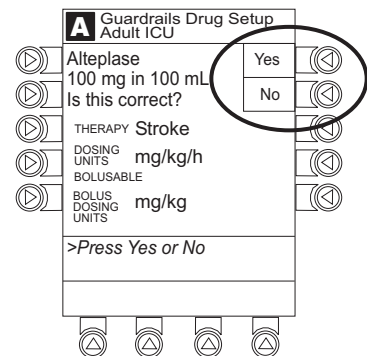

-- Continued on Next Page --

Primary Infusion - With Guardrails® Suite MX Protection (Continued)

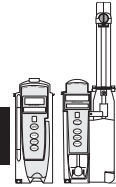

Continuous Infusion (Continued)

- If **Yes** was selected and facility has defined a Clinical Advisory for that drug, a message appears. To indicate information has been noted and continue programming, press **CONFIRM** soft key.

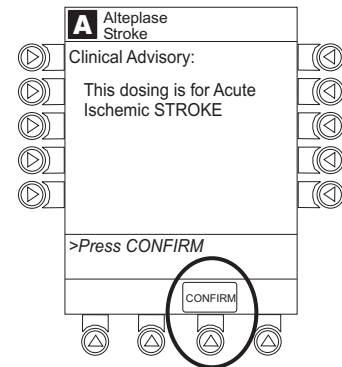

- If **Yes** was selected to continue programming, drug amount and diluent volume (if defined in Drug Library) are automatically entered for selected drug.

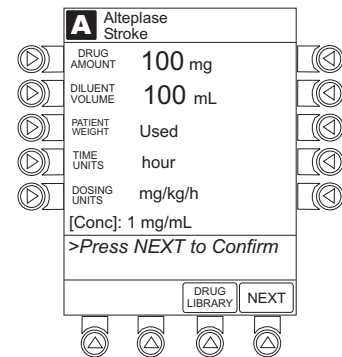

- If selected drug had "___ / ___ mL" concentration, drug amount and diluent volume need to be entered.
- If selected drug is not weight-based, **Not Used** displays in **PATIENT WEIGHT** field.
- If hospital/facility practice guidelines identify selected drug as weight-based, prompt for a patient weight in kilograms appears (as in illustrated example, which reflects use of Alteplase). ③

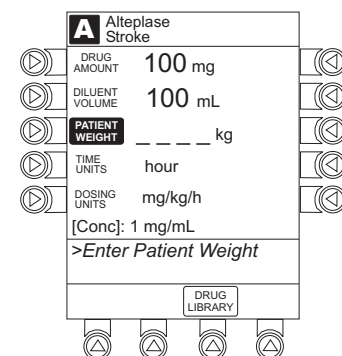

4. Verify parameters are correct and press **NEXT** soft key to confirm.

Primary Infusion - With Guardrails® Suite MX Protection (Continued)

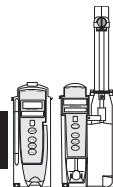

Continuous Infusion (Continued)

- An optional hospital-defined and editable starting value for continuous infusion dose may already be entered.

OR

To make a rate or dose entry, press applicable soft key, **RATE** or **DOSE**, and use numeric data entry keys (other value is calculated and displayed).

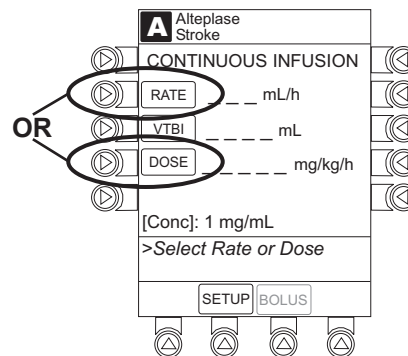

- To enter volume to be infused, press **VTBI** soft key and use numeric data entry keys. ⁴ ⁵
 - BOLUS** soft key appears only if Bolus Dose is enabled within selected profile, drug is bolusable, and a VTBI is entered.

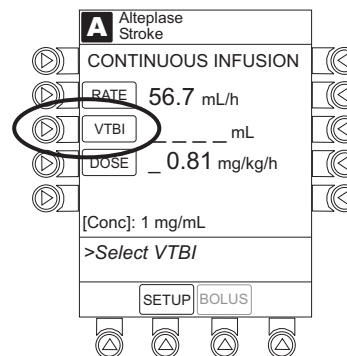

- Syringe Module:
 - When **VTBI ALL** is enabled, **VTBI** soft key is inactive and estimated available volume in syringe displays. When **VTBI** soft key is pressed, a new value can be entered.
 - When **VTBI ALL** is disabled and **VTBI** soft key is pressed, estimated available volume in syringe displays.

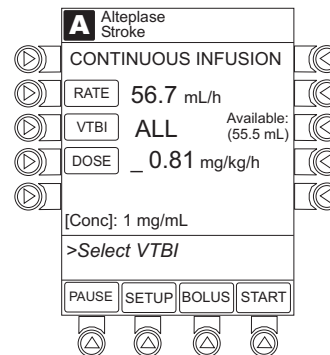

Primary Infusion - With Guardrails® Suite MX Protection (Continued)

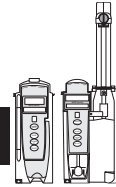

Continuous Infusion (Continued)

7. Verify parameters are correct and press **START** soft key.

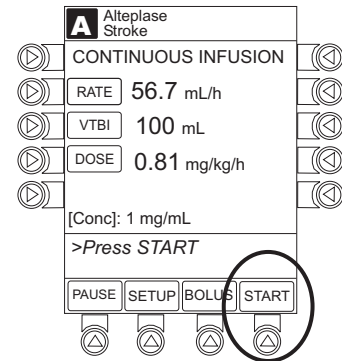

- If programmed continuous dose infusion is outside Soft Limit for that care area, an audio alert sounds and a visual prompt appears before programming can continue. If **Yes** soft key is pressed, programming continues; if **No** soft key is pressed, infusion needs to be reprogrammed.

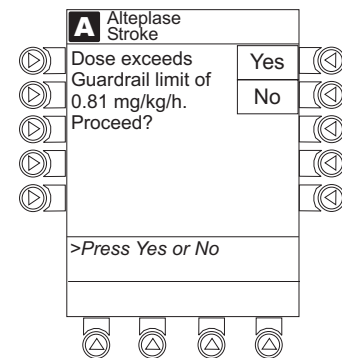

- If programmed continuous dose infusion is outside Hard Limit for that care area, an audio alert sounds and a visual prompt appears before programming can continue. Infusion needs to be reprogrammed.

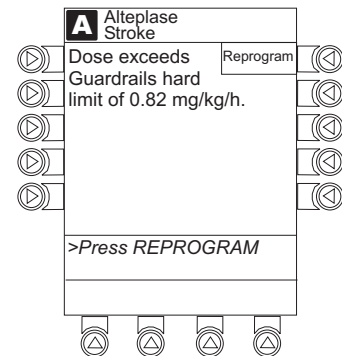

- If a dose outside of Soft Limit has been entered and verified as correct, Message Display also shows either "LLL" for a low dose or "↑↑↑" for a high dose.

-- Continued on Next Page --

Primary Infusion - With Guardrails® Suite MX Protection (Continued)

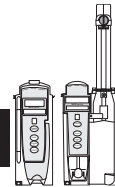

Continuous Infusion (Continued)

- If a Soft Limit is overridden, **G** icon displays. When **G** soft key is pressed, all applicable out-of-range limits are listed.

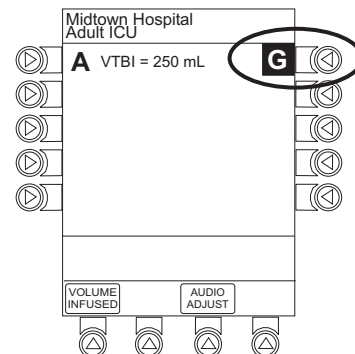

8.  Syringe Module: Attach administration set to patient. ⑥

NOTES: (Continued)

- ① To view additional drugs/concentrations, press a soft key next to a letter group to navigate through alphabet, and/or **PAGE UP** and **PAGE DOWN** soft keys.
- ② The facility may choose to prepopulate standard drug concentrations, or leave an open entry (_ _ / _ _ mL) and allow the clinician to enter the desired concentration.
- ③ Once a patient weight is entered, for any module, it is automatically entered for any subsequent weight-based calculation.
- ④ Pump Module: At rates less than 10 mL/h, the rate is displayed to 2 decimal places, and the VTBI can be entered and is displayed to 2 decimal places.
- ⑤ Pump Module: In the Drug Calculation mode, the system infuses at the calculated rate rounded to the nearest one-hundredth of a mL per hour (as displayed on programming screen). The rate shown in the Rate Display is rounded to the nearest one-tenth of a mL per hour.
- ⑥ Syringe Module: Starting the infusion before attaching the administration set to the patient minimizes any potential bolus that can be released from pressure built up in the set due to normal syringe loading and priming.

Primary Infusion - With Guardrails® Suite MX Protection (Continued)

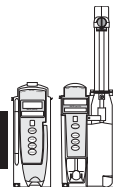

Bolus Dose

A bolus dose can be programmed at the beginning of, or during, an infusion. The drug being programmed must be a bolusable drug selected from the Drug Library or a non-library drug, as described in the following procedures. ① ② ③ ④

1. Set up infusion as described in "Continuous Infusion" procedure, but do not start infusion.
2. Press **BOLUS** soft key.
 - If programmed continuous dose infusion is outside Soft Limit for that care area, an audio alert sounds and a visual prompt appears before programming can continue. If **Yes** soft key is pressed, programming continues; if **No** soft key is pressed, infusion needs to be reprogrammed.
 - If programmed continuous dose infusion is outside Hard Limit for that care area, an audio alert sounds and a visual prompt appears before programming can continue. Infusion needs to be reprogrammed.
3. An optional hospital-defined and editable starting value for bolus dose and/or bolus rate duration may already be entered.

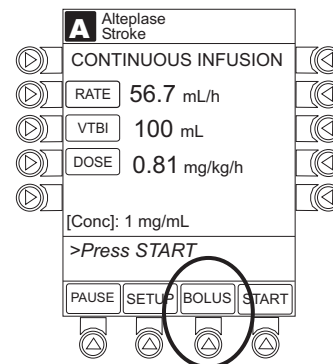

OR

To enter bolus dose, use numeric data entry keys.

- After a bolus dose and weight (if used) are entered, bolus VTBI and concentration [conc] alternate in Main Display.
- If no weight has previously been programmed in system and bolus dose is weight-based, weight entry is empty.
- If programmed continuous dose is weight-based, programmed weight displays.
- If bolus dose is not weight-based, **Not Used** displays in **PATIENT WEIGHT** field.

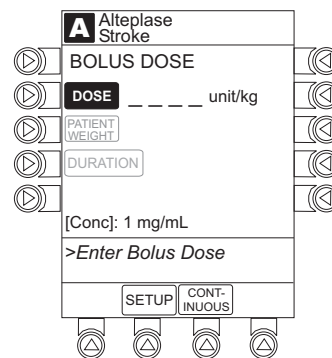

Primary Infusion - With Guardrails® Suite MX Protection (Continued)

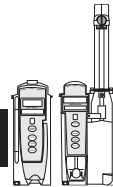

Bolus Dose (Continued)

4. To enter or change patient weight (if used), use applicable following procedure, depending on whether or not continuous dose is weight-based.

- To enter a weight when continuous dose is not weight-based:
 - a. Press **PATIENT WEIGHT** soft key.
 - b. To enter patient weight, use numeric data entry keys.

OR

- To change weight when continuous dose is weight-based:
 - a. Press **SETUP** soft key.
 - b. Press **PATIENT WEIGHT** soft key.
 - c. To change patient weight, use numeric data entry keys.
 - d. Press **NEXT** soft key.
 - If a continuous infusion is running, a prompt to confirm weight change appears.

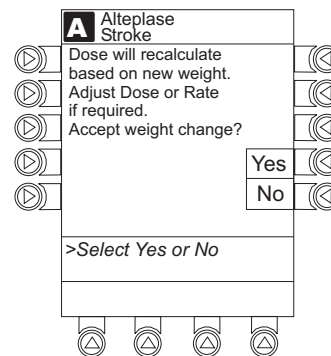

- e. Press **BOLUS** soft key.
- f. To enter bolus dose, use numeric data entry keys.

5. Press **DURATION** soft key.

Primary Infusion - With Guardrails® Suite MX Protection (Continued)

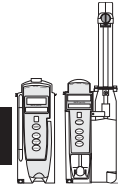

Bolus Dose (Continued)

6. To enter bolus duration, use numeric data entry keys.

OR

To deliver bolus dose at maximum safe rate possible for selected drug and setup, and automatically calculate bolus duration, press **Rapid Bolus** soft key.

- **TOTAL DOSE** alternates with **INFUSE AT** rate.

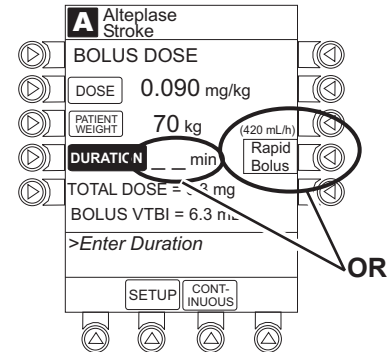

7. Verify parameters are correct and press **START** soft key. ⑤

- If programmed bolus dose and/or bolus dose duration is outside Soft Limit for that care area, an audio alert sounds and a visual prompt appears before programming can continue. If **Yes** soft key is pressed, programming continues; if **No** soft key is pressed, infusion needs to be reprogrammed.
- If programmed bolus dose and/or bolus dose duration is outside Hard Limit for that care area, an audio alert sounds and a visual prompt appears before programming can continue. Infusion needs to be reprogrammed.
- If a bolus dose outside of Soft Limits has been entered and verified as correct, Message Display also shows either "LLL" for a low dose or "↑↑↑" for a high dose.
- If a Soft Limit is overridden, **G** icon displays. When **G** soft key is pressed, all applicable out-of-range limits are listed.

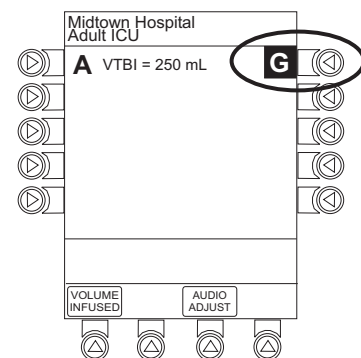
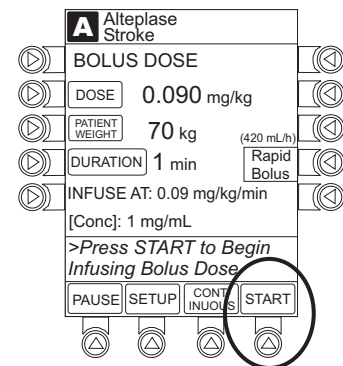

Primary Infusion - With Guardrails® Suite MX Protection (Continued)

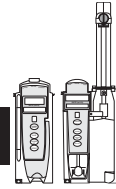

Bolus Dose (Continued)

8. Syringe Module: If bolus dose was programmed at beginning of infusion, attach administration set to patient. ⑥

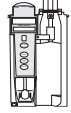

Stopping Bolus Dose

The display examples in this procedure represent stopping a bolus dose which was programmed using the Drug Library. Even where the displays are different when stopping a bolus dose which was programmed using a non-library drug, the procedure is the same.

1. Press **CHANNEL SELECT** key.
2. Press **STOP BOLUS** soft key.

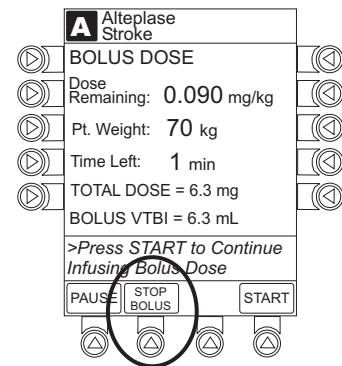

3. To stop bolus and start continuous infusion, press **Yes** soft key.

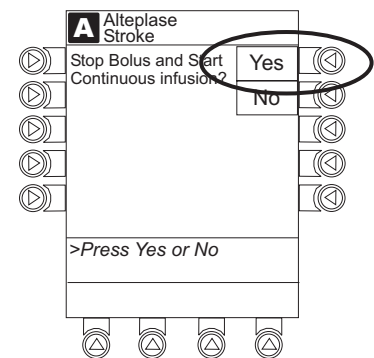

Primary Infusion - With Guardrails® Suite MX Protection (Continued)

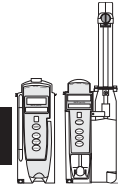

Bolus Dose (Continued)

Stopping Bolus Dose (Continued)

4. To stop continuous infusion, press and hold **CHANNEL OFF** key until a beep is heard (approximately 1.5 seconds). ^⑦

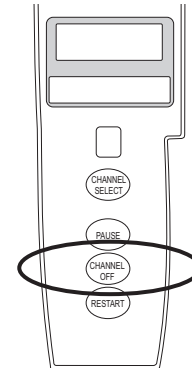

Restoring Bolus Dose

A bolus dose can be restored after it has completed, either prior to or after the module has been turned off, as indicated in the following procedures.

The display examples in this procedure represent restoring a bolus dose which was programmed using the Drug Library. Even where the displays are different when restoring a bolus dose which was programmed using a non-library drug, the procedure is the same.

1. Bolus dose completed - module not turned off:
 - a. Press **CHANNEL SELECT** key.
 - b. Verify infusion parameters and press **BOLUS** soft key.
 - c. Press **RESTORE** soft key.
 - d. Verify dosing parameters and press **START** soft key.
2. Bolus dose completed - module turned off:
 - a. Press **CHANNEL SELECT** key.
 - b. Press **RESTORE** soft key.
 - c. Verify parameters and press **NEXT** soft key.
 - d. Verify infusion parameters and press **BOLUS** soft key.

Primary Infusion - With Guardrails® Suite MX Protection (Continued)

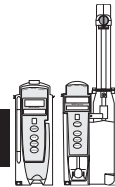

Bolus Dose (Continued)

Restoring Bolus Dose (Continued)

- e. Press **RESTORE** soft key.
- f. Verify dosing parameters and press **START** soft key.

NOTES:

- ① If the Bolus Dose feature is enabled, the **BOLUS** soft key appears in the Continuous Infusion screen and becomes active when a VTBI is entered.
- ② The bolus VTBI cannot exceed the programmed continuous infusion VTBI.
- ③ Programming and starting a bolus dose deletes any programmed delay.
- ④ If no continuous rate is entered, the infusion ends when the bolus has been delivered. No KVO infusion follows.
- ⑤ To see details during the bolus infusion, press the **CHANNEL SELECT** key.
- ⑥ Syringe Module: Starting the infusion before attaching the administration set to the patient minimizes any potential bolus that can be released from pressure built up in the set due to normal syringe loading and priming.
- ⑦ The Pump Module keypad is used in the illustration but the key is the same for the Syringe Module.

Intermittent Infusion

When using a drug listed in the Drug Library, the drug parameters are automatically delivered, based on:

- drug selected
- weight or body surface area (BSA) entry (if required)
- dose entry
- rate or duration dose entry
- VTBI entry

Syringe Module: The KVO option is disabled when an intermittent infusion is programmed.

1. Press Guardrails Drugs soft key.

Primary Infusion - With Guardrails® Suite MX Protection (Continued)

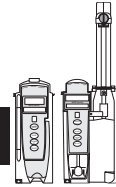

Intermittent Infusion (Continued)

2. Press soft key next to desired drug. ^①
 - If applicable, an optional hospital-defined therapy or clinical indication for delivery of this infusion may appear. Different limits can be defined for same drug with different therapeutic indications.
 - If applicable, a weight-based, non weight-based, or BSA-based option for delivery of this infusion may appear.
 - If applicable, multiple concentration listings for delivery of this infusion may appear.

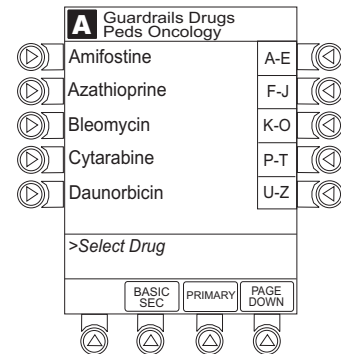

3. To continue programming, press **Yes** soft key. ^②

OR

To change selection, press **No** soft key.

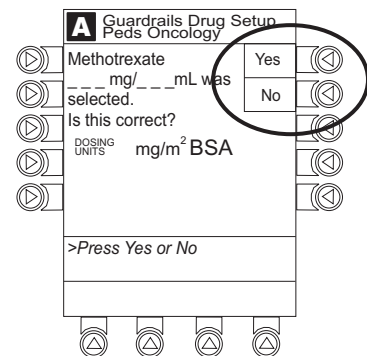

- If **Yes** was selected and facility has defined a Clinical Advisory for that drug, a message appears. To indicate information has been noted and continue programming, press **CONFIRM** soft key.
- If **Yes** was selected to continue programming, drug amount and diluent volume (if defined in Drug Library) are automatically entered for selected drug.
- If selected drug had "___ / ___ mL" concentration, drug amount and diluent volume need to be entered.
- If selected drug is not weight-based, **Not Used** displays in **PATIENT WEIGHT** field.

-- Continued on Next Page --

Primary Infusion - With Guardrails® Suite MX Protection (Continued)

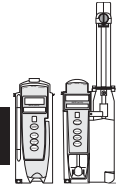

Intermittent Infusion (Continued)

- If hospital/facility practice guidelines identify selected drug as weight-based, prompt for a patient weight in kilograms or BSA appears (as in illustrated example, which reflects use of Methotrexate). ^③

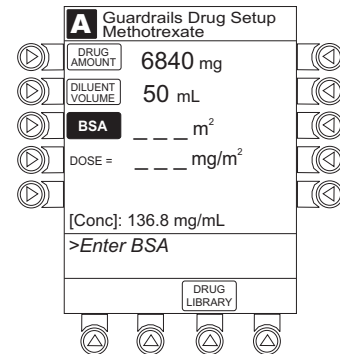

- Verify parameters are correct and press **NEXT** soft key to confirm.
 - If programmed total dose drug amount is outside Soft Limit for that care area, an audio alert sounds and a visual prompt appears before programming can continue. If **Yes** soft key is pressed, programming continues; if **No** soft key is pressed, infusion needs to be reprogrammed.
 - If programmed total dose drug amount is outside Hard Limit for that care area, an audio alert sounds and a visual prompt appears before programming can continue. Infusion needs to be reprogrammed.
 - If a dose outside of Soft Limits has been entered and verified as correct, Message Display also shows either "LLL" for a low dose or "↑↑↑" for a high dose.
 - If a Soft Limit is overridden, **G** icon displays. When **G** soft key is pressed, all applicable out-of-range limits are listed.

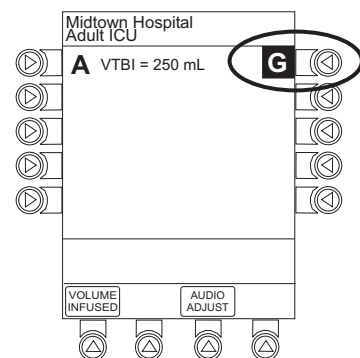

Primary Infusion - With Guardrails® Suite MX Protection (Continued)

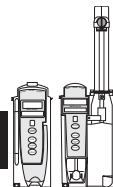

Intermittent Infusion (Continued)

5. VTBI entry:
 - Pump Module: VTBI is prepopulated with diluent volume of infusion. To change VTBI, press **VTBI** soft key and use numeric data entry keys. ④
 - Syringe Module:
 - ◆ When **VTBI ALL** is enabled, **VTBI** soft key is inactive and estimated available volume in syringe displays. When **VTBI** soft key is pressed, a new value can be entered.
 - ◆ When **VTBI ALL** is disabled and **VTBI** soft key is pressed, estimated available volume in syringe displays.

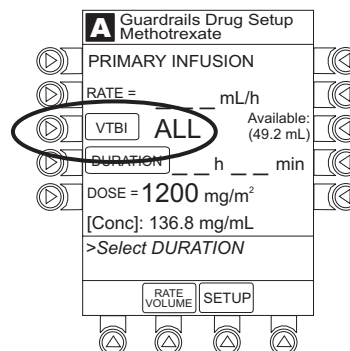

6. If an optional hospital-defined and editable starting value for intermittent duration is not already entered, enter duration or rate, as follows:
 - To enter duration, press **DURATION** soft key and use numeric data entry keys (rate value is calculated and displayed).
 - To enter rate, press **RATE VOLUME** soft key and use numeric data entry keys.

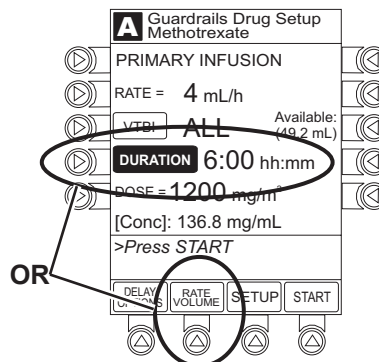

7. Verify parameters are correct and press **START** soft key.
 - If programmed duration is outside Soft Limit for that care area, an audio alert sounds and a visual prompt appears before programming can continue. If **Yes** soft key is pressed, programming continues; if **No** soft key is pressed, infusion needs to be reprogrammed.
 - If programmed duration is outside Hard Limit for that care area, an audio alert sounds and a visual prompt appears before programming can continue. Infusion needs to be reprogrammed.
 - If a Soft Limit is overridden, **G** icon displays. When **G** soft key is pressed, all applicable out-of-range limits are listed.

Primary Infusion - With Guardrails® Suite MX Protection (Continued)

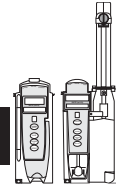

Intermittent Infusion (Continued)

- Syringe Module: Attach administration set to patient. ⑤

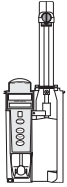

NOTES:

- To view additional drugs, press a soft key next to a letter group to navigate through alphabet, and/or **PAGE UP** and **PAGE DOWN** soft keys.
- The facility may choose to prepopulate standard drug concentrations, or leave an open entry (_ _ / _ _ mL) and allow the clinician to enter the desired concentration.
- Once a patient weight or BSA is entered, for any module, it is automatically entered for any subsequent weight-based calculation.
- Pump Module: At rates less than 10 mL/h, the rate is displayed to 2 decimal places, and the VTBI can be entered and is displayed to 2 decimal places.
- Syringe Module: Starting the infusion before attaching the administration set to the patient minimizes any potential bolus that can be released from pressure built up in the set due to normal syringe loading and priming.

IV Fluid Infusion

- Press **Guardrails IV Fluids** soft key.
- Press soft key next to IV Fluid to be delivered.

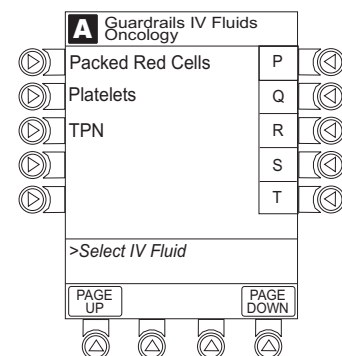

Primary Infusion - With Guardrails® Suite MX Protection (Continued)

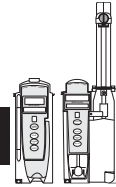

IV Fluid Infusion (Continued)

3. To confirm selection, press **Yes** soft key.

OR

To return to IV Fluid library list, press **No** soft key.

- If **Yes** was selected and facility has defined a Clinical Advisory for that drug, a message appears. To indicate information has been noted and continue programming, press **CONFIRM** soft key.

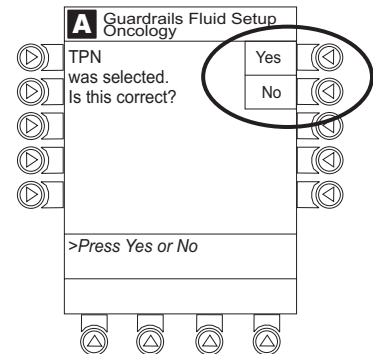

4. Start applicable infusion, as described in following procedures:

- Rate/Volume Infusion
- Volume/Duration Infusion

Rate/Volume Infusion

1. To enter flow rate, press **RATE** soft key and use numeric data entry keys.

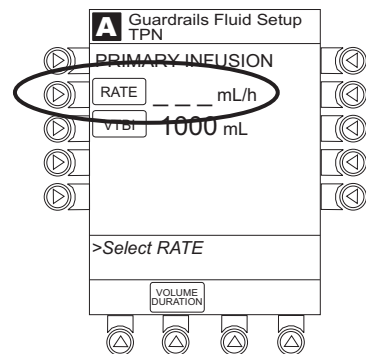

2. To enter **VTBI**, press **VTBI** soft key and use numeric data entry keys.

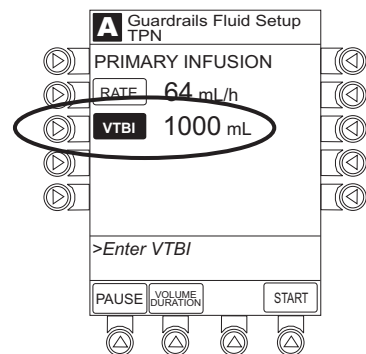

-- Continued on Next Page --

Primary Infusion - With Guardrails® Suite MX Protection (Continued)

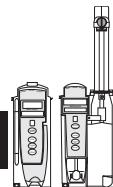

IV Fluid Infusion (Continued)

Rate/Volume Infusion (Continued)

- Syringe Module: ①
 - ◆ When **VTBI ALL** is enabled, **VTBI** soft key is inactive and estimated available volume in syringe displays. When **VTBI** soft key is pressed, a new value can be entered.
 - ◆ When **VTBI ALL** is disabled and **VTBI** soft key is pressed, estimated available volume in syringe displays.

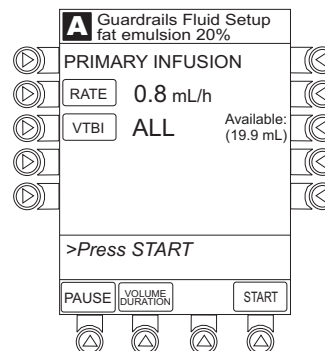

3. Verify correct infusion parameter entry and press **START** soft key. ②

- If programmed IV Fluid is outside Soft Limit for that care area, an audio alert sounds and a visual prompt appears before programming can continue. If **Yes** soft key is pressed, programming continues; if **No** soft key is pressed, infusion needs to be reprogrammed.
- If programmed IV Fluid is outside Hard Limit for that care area, an audio alert sounds and a visual prompt appears before programming can continue. Infusion needs to be reprogrammed.
- If a Soft Limit is overridden, **G** icon displays. When **G** soft key is pressed, all applicable out-of-range limits are listed.

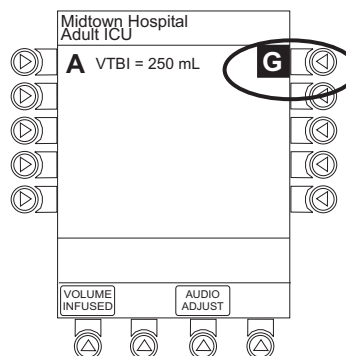

4. Syringe Module: Attach administration set to patient. ③

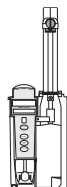

Primary Infusion - With Guardrails® Suite MX Protection (Continued)

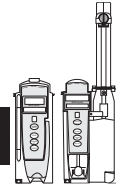

IV Fluid Infusion (Continued)

Volume/Duration Infusion

1. Press **VOLUME DURATION** soft key.

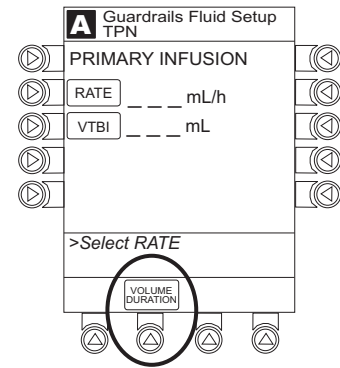

2. To enter **VTBI**, press **VTBI** soft key and use numeric data entry keys.

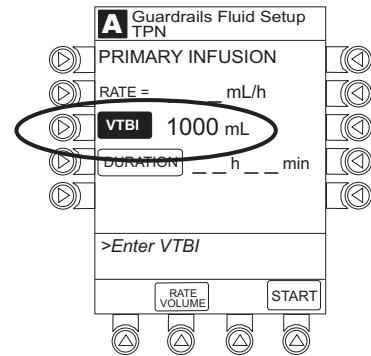

- Syringe Module: ①
 - ◆ When **VTBI ALL** is enabled, **VTBI** soft key is inactive and estimated available volume in syringe displays. When **VTBI** soft key is pressed, a new value can be entered.
 - ◆ When **VTBI ALL** is disabled and **VTBI** soft key is pressed, estimated available volume in syringe displays.

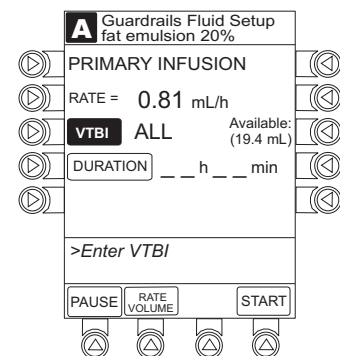

Primary Infusion - With Guardrails® Suite MX Protection (Continued)

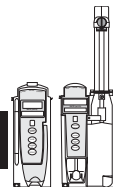

IV Fluid Infusion (Continued)

Volume/Duration Infusion (Continued)

- To enter volume duration, press **DURATION** soft key and use numeric data entry keys.
 - Rate is automatically calculated.
- Verify correct infusion parameter entry and press **START** soft key. ^④
 - If programmed IV Fluid is outside Soft Limit for that care area, an audio alert sounds and a visual prompt appears before programming can continue. If **Yes** soft key is pressed, programming continues; if **No** soft key is pressed, infusion needs to be reprogrammed.
 - If programmed IV Fluid is outside Hard Limit for that care area, an audio alert sounds and a visual prompt appears before programming can continue. Infusion needs to be reprogrammed.
 - If a Soft Limit is overridden, **G** icon displays. When **G** soft key is pressed, all applicable out-of-range limits are listed.
-  Syringe Module: Attach administration set to patient. ^③

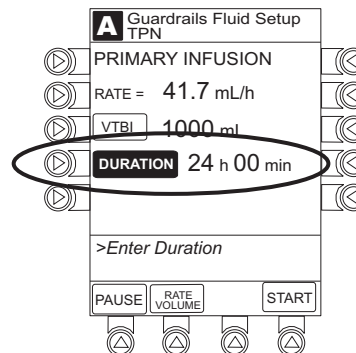

NOTES:

- ^① Syringe Module: When ALL MODE is disabled, the VTBI ALL option is not available.
- ^② The infusion may be paused by pressing the **PAUSE** soft key. See "Pausing, Changing, Restarting Infusion", "Pausing and Restarting Infusion" procedure.
- ^③ Syringe Module: Starting the infusion before attaching the administration set to the patient minimizes any potential bolus that can be released from pressure built up in the set due to normal syringe loading and priming.

-- Continued on Next Page --

Primary Infusion - With Guardrails® Suite MX Protection (Continued)

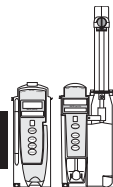

IV Fluid Infusion (Continued)

Volume/Duration Infusion (Continued)

NOTES: (Continued)

- ④ To view infusion **Time Left** during a volume/duration infusion, → press **CHANNEL SELECT** key. To return to previous screen, press **START** soft key.

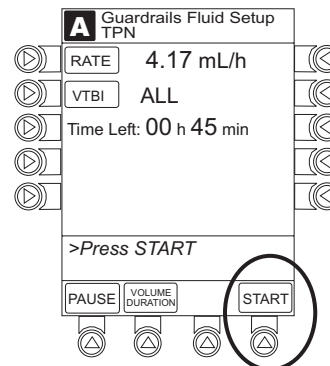

Secondary Infusion - With Guardrails® Suite MX Protection (Pump Module)



Introduction

This mode is designed to support automatic secondary infusions ("piggybacking") in the same instrument. A secondary infusion can be programmed as a "Basic Infusion" or "Drug Library Infusion". When the secondary VTBI reaches zero, an audio tone sounds (if enabled) indicating completion of the secondary infusion. The primary infusion resumes automatically.

When the instrument is programmed and delivering in the secondary mode, the primary infusion is temporarily stopped and fluid is drawn from the secondary container. Delivery from the primary container resumes when the fluid level in the secondary line is level with the fluid in the primary container.

WARNINGS

- Secondary applications require the use of a **check valve set** on the primary IV line.
- The **secondary solution container** must be higher than the primary solution container.
- The **secondary VTBI settings** require consideration of such variables as factory overflow, medication additions, etc. Underestimating the volume causes the remaining secondary solution to be infused at the primary rate; overestimating results in the primary solution being infused at the secondary rate. Multiple doses from a single container are not possible.

-- Continued on Next Page --

Secondary Infusion - With Guardrails® Suite MX Protection (Pump Module) (Continued)



Setup

1. Open secondary administration set package, remove set and close clamp.
2. Insert administration set spike into prepared fluid container and hang secondary container, following accepted hospital/facility procedure.
3. Fill drip chamber to 2/3 full.
4. Open secondary administration set clamp and prime set. Close clamp.
5. Attach secondary administration set to upper injection site on primary set.
6. Using hanger provided with secondary administration set, lower primary fluid container to height indicated in following illustrations.

WARNINGS

- The clamp on the secondary administration set must be opened. If the **clamp is not opened**, the fluid is delivered from the primary container.
- The secondary administration set **must be primed** prior to beginning the secondary infusion.

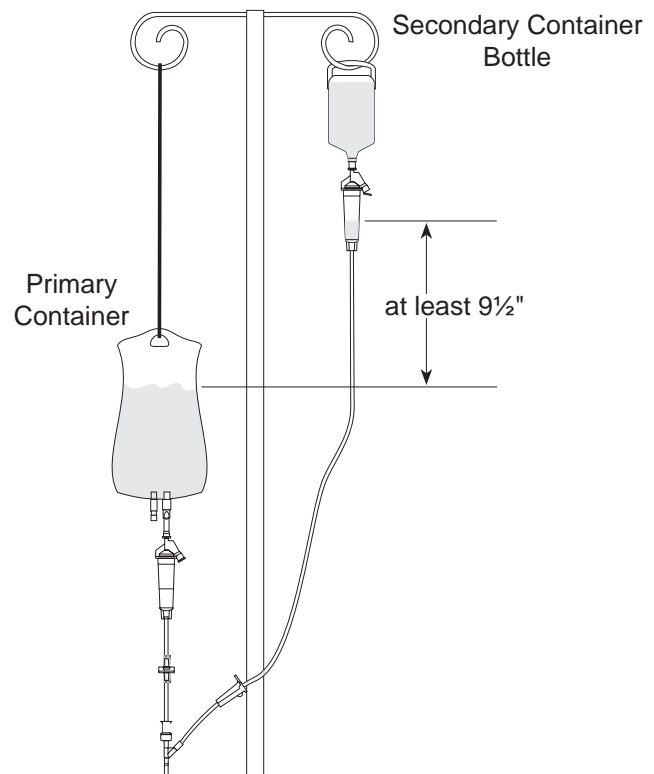
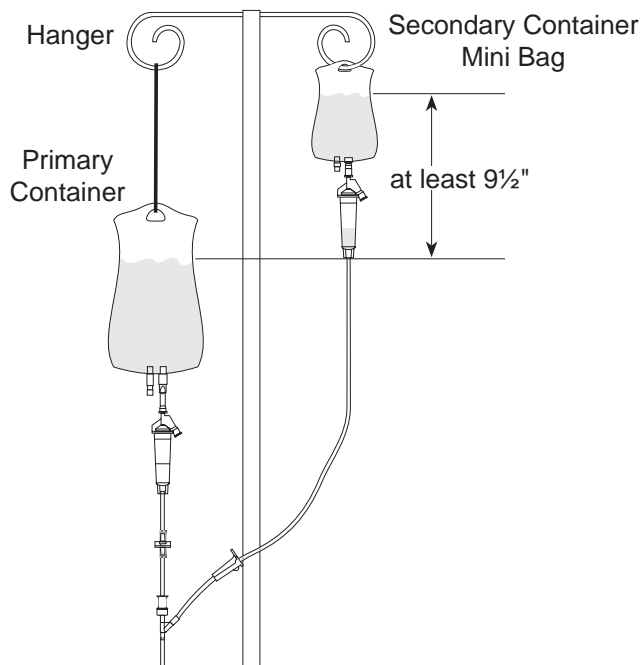

Secondary Infusion - With Guardrails® Suite MX Protection (Pump Module) (Continued)



Infusion

The following procedure should be used only when:

- drug to be infused is listed in Drug Library,
- primary infusion is running, and
- a check valve administration set is being used.

To program a primary infusion, see "IV Fluid Infusion" procedure. To program a basic infusion, see "Infusion - NO Guardrails® Suite MX Protection" procedure.

1. Press **CHANNEL SELECT** key.
2. Press **SECONDARY** soft key.

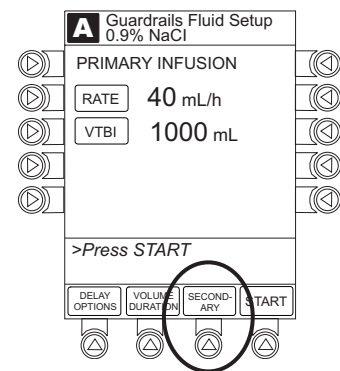

3. Press soft key next to desired drug. ^①
 - If applicable, an optional hospital-defined therapy or clinical indication for delivery of this infusion may appear. Different limits can be defined for same drug with different therapeutic indications.
 - If applicable, a weight-based, non weight-based, or BSA-based option for delivery of this infusion may appear.
 - If applicable, multiple concentration listings for delivery of this infusion may appear.

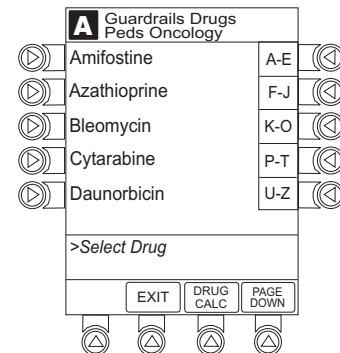

Secondary Infusion - With Guardrails® Suite MX Protection (Pump Module) (Continued)



Infusion (Continued)

4. To continue programming, press **Yes** soft key. ^②

OR

To change selection, press **No** soft key.

- If **Yes** was selected and facility has defined a Clinical Advisory for that drug, a message appears. To indicate information has been noted and continue programming, press **CONFIRM** soft key.
- If **Yes** was selected to continue programming, drug amount and diluent volume (if defined in Drug Library) are automatically entered for selected drug.
- If selected drug had "__ / __ mL" concentration, drug amount and diluent volume need to be entered.
- If selected drug is not weight-based, **Not Used** displays in **PATIENT WEIGHT** field.
- If hospital/facility practice guidelines identify selected drug as weight-based, prompt for a patient weight in kilograms or BSA appears (as in illustrated example, which reflects use of Methotrexate). ^③

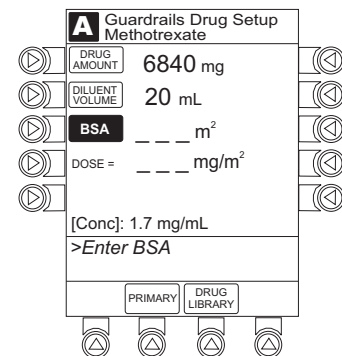
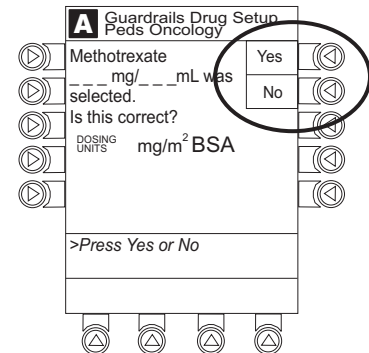

5. Verify parameters are correct and press **NEXT** soft key to confirm.

- If programmed total dose drug amount is outside Soft Limit for that care area, an audio alert sounds and a visual prompt appears before programming can continue. If **Yes** soft key is pressed, programming continues; if **No** soft key is pressed, infusion needs to be reprogrammed.
- If programmed total dose drug amount is outside Hard Limit for that care area, an audio alert sounds and a visual prompt appears before programming can continue. Infusion needs to be reprogrammed.

-- Continued on Next Page --

Secondary Infusion - With Guardrails® Suite MX Protection (Pump Module) (Continued)



Infusion (Continued)

- If a dose outside of Soft Limits has been entered and verified as correct, Message Display also shows either "LLL" for a low dose or "↑↑↑" for a high dose.
- If a Soft Limit is overridden, **G** icon displays. When **G** soft key is pressed, all applicable out-of-range limits are listed.

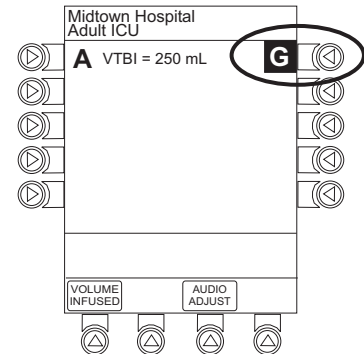

6. VTBI is prepopulated with diluent volume of infusion. To change VTBI, press **VTBI** soft key and use numeric data entry keys. ^④

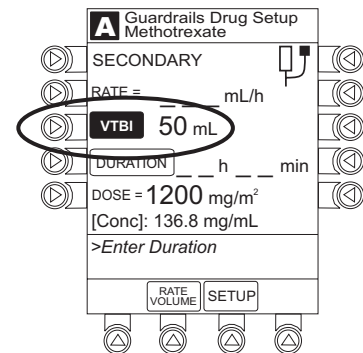

7. If an optional hospital-defined and editable starting value for intermittent duration is not already entered, enter duration or rate, as follows:

- To enter duration, press **DURATION** soft key and use numeric data entry keys (rate value is calculated and displayed).
- To enter rate, press **RATE VOLUME** soft key and use numeric data entry keys.

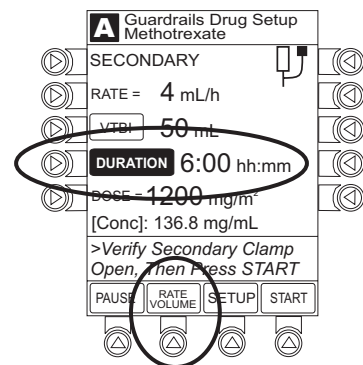

Secondary Infusion - With Guardrails® Suite MX Protection (Pump Module) (Continued)



Infusion (Continued)

8. Verify parameters are correct and press **START** soft key.
 - If programmed duration is outside Soft Limit for that care area, an audio alert sounds and a visual prompt appears before programming can continue. If **Yes** soft key is pressed, programming continues; if **No** soft key is pressed, infusion needs to be reprogrammed.
 - If programmed duration is outside Hard Limit for that care area, an audio alert sounds and a visual prompt appears before programming can continue. Infusion needs to be reprogrammed.
 - If a Soft Limit is overridden, **G** icon displays. When **G** soft key is pressed, all applicable out-of-range limits are listed.

NOTES:

- ① To view additional drugs, press a soft key next to a letter group to navigate through alphabet, and/or **PAGE UP** and **PAGE DOWN** soft keys.
- ② The facility may choose to prepopulate standard drug concentrations, or leave an open entry (_ _ / _ _ mL) and allow the clinician to enter the desired concentration.
- ③ Once a patient weight or BSA is entered, for any module, it is automatically entered for any subsequent weight-based calculation.
- ④ At rates less than 10 mL/h, the rate is displayed to 2 decimal places, and the VTBI can be entered and is displayed to 2 decimal places.

Stopping Secondary and Returning to Primary

1. Press **CHANNEL SELECT** key.
2. Press **SETUP** soft key.
3. Press **PRIMARY** soft key.
4. Close clamp on secondary administration set.
OR
Disconnect secondary administration set from upper injection port.
5. Press **START** soft key.

Secondary Infusion - With Guardrails® Suite MX Protection (Pump Module) (Continued)



Stopping Secondary and Returning to Primary (Continued)

6. To stop secondary infusion and begin infusing primary, press **Yes** soft key. ^①
 - Secondary infusion stops and primary infusion begins.
 - Main screen appears.

NOTE:

- ① The SEC to PRI alert does not sound when the infusion is manually ended and returned to primary.

Infusion - NO Guardrails® Suite MX Protection

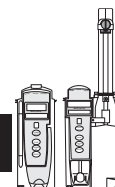

The following procedures should be used only when the drug to be infused is not listed in the Drug Library. When programming a drug not listed in the Drug Library, the drug calculation must be programmed using the **DRUG CALC** soft key within the Drug Library. There are no limits associated with any non-library drug calculation.

1. Perform following steps (see PC Unit Section of this DFU, "General Setup and Operation", "Start-Up"):
 - a. Power on system.
 - b. Choose **Yes** or **No** to **New Patient?**
 - c. Confirm current profile or select a new profile.
 - d. Enter patient identifier, if required.
2. Prepare and load syringe/administration set (see "Getting Started").
3. Prime (see "Getting Started").
4. Start applicable infusion, as described in following procedures:
 - Basic Infusion
 - Continuous Infusion - Drug Calculation
 - Bolus Dose

Infusion - NO Guardrails® Suite MX Protection (Continued)

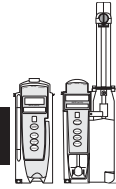

Basic Infusion

The following procedures should be used only to set up a **Basic Infusion**. To program an infusion using **Guardrails Drugs**, see "Primary Infusion - With Guardrails® Suite MX Protection".

The illustrations in this procedure assume: ①

- ALL Mode (Syringe Module), Drug Calculation, Dynamic Pressure Display, Profiles, and Volume Duration configurable settings are enabled.
 - NEOI (Syringe Module) and Delay Options configurable settings are disabled.
1. Press **CHANNEL SELECT** key.
 2. Press **Basic Infusion** soft key.
 - **Infusion Setup** screen appears.
 3. Start applicable infusion, as described in following procedures.

Rate/Volume Infusion

Volume/Duration Infusion

NOTE:

- ① If Delay Options is enabled, the **PAUSE** soft key becomes **DELAY OPTIONS**.

Rate / Volume and Volume / Duration Infusions

See "Primary Infusion - With Guardrails® Suite MX Protection", "IV Fluid Infusion" procedure.

WARNING

When the **pressure sensing disc is not being used** and an occlusion occurs, there is a risk of infusing pressurized buildup of infusates upon correction of the occlusion. To avoid an inadvertent bolus, relieve the pressure before restarting the infusion.

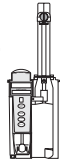

Infusion - NO Guardrails® Suite MX Protection (Continued)

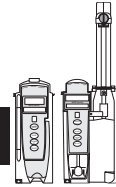

Promoting Basic Infusion to Guardrails® Suite MX Protection Infusion

1. Press **CHANNEL SELECT** key on module running infusion to be promoted.
2. Press **OPTIONS** key.

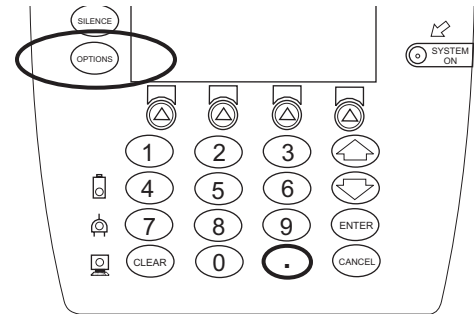

3. Press **Guardrails Drugs** soft key.
4. Continue programming (see "Primary Infusion - With Guardrails® Suite MX Protection").

Continuous Infusion - Drug Calculation

1. Press **Guardrails Drugs** soft key.
2. Press **DRUG CALC** soft key.

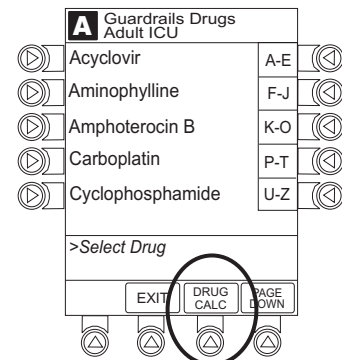

3. To enter **DRUG AMOUNT** in syringe, use numeric data entry keys.
4. Press soft key for appropriate unit of measure for drug amount.
5. To enter diluent volume, use numeric data entry keys.
6. Press **PATIENT WEIGHT** soft key.

Infusion - NO Guardrails® Suite MX Protection (Continued)

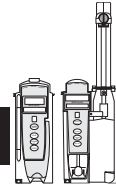

Continuous Infusion - Drug Calculation (Continued)

7. To indicate whether or not patient weight is to be used in Drug Calculation, press either **Yes** or **No** soft key. ^①
8. To enter patient weight (if required) in kilograms, use numeric data entry keys.
9. Press **TIME UNITS** soft key.
10. To select time base for drug calculation, press either **Min**, **Hour**, or **Day** soft key.
11. Press soft key next to desired **DOSING UNITS**.
12. Verify correct infusion parameters and press **NEXT** soft key.
 - Syringe Module: If ALL Mode is enabled, **VTBI ALL** displays.
13. To make a rate or dose entry, press applicable soft key, **RATE** or **DOSE**, and use numeric data entry keys (other value is calculated and displayed).
14. To enter volume to be infused, press **VTBI** soft key and use numeric data entry keys. ^{② ③}
 - Syringe Module:
 - ◆ When **VTBI ALL** is enabled, **VTBI** soft key is inactive and estimated available volume in syringe displays. When **VTBI** soft key is pressed, a new value can be entered.
 - ◆ When **VTBI ALL** is disabled and **VTBI** soft key is pressed, estimated available volume in syringe displays.
 - **BOLUS** soft key appears only if Bolus Dose is enabled within selected profile, drug is bolusable, and a VTBI is entered.
15. Verify parameters are correct and press **START** soft key.
16. Syringe Module: Attach administration set to patient. ^④

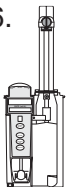
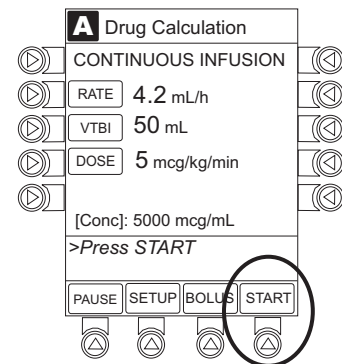

-- Continued on Next Page --

Infusion - NO Guardrails® Suite MX Protection (Continued)

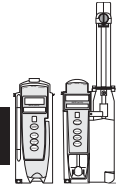

Continuous Infusion - Drug Calculation (Continued)

NOTES:

- ① Do not enter a patient weight if weight is not used in the calculation.
- ② Pump Module: At rates less than 10 mL/h, the rate is displayed to two decimal places, and the VTBI can be entered and is displayed to two decimal places.
- ③ Pump Module: In the Drug Calculation mode, the system infuses at the calculated rate rounded to the nearest one-hundredth of a mL per hour (as displayed on the programming screen). The rate shown in the Rate Display is rounded to the nearest one-tenth of a mL per hour.
- ④ Syringe Module: Starting the infusion before attaching the administration set to the patient minimizes any potential bolus that can be released from pressure built up in the set due to normal syringe loading and priming.

Bolus Dose

1. Set up infusion as described in "Continuous Infusion - Drug Calculation" procedure, but do not start infusion.
2. Press **BOLUS** soft key.
3. To enter bolus dose, use numeric data entry keys.
 - After a bolus dose and weight (if used) are entered, bolus VTBI and concentration [conc] alternate in Main Display.

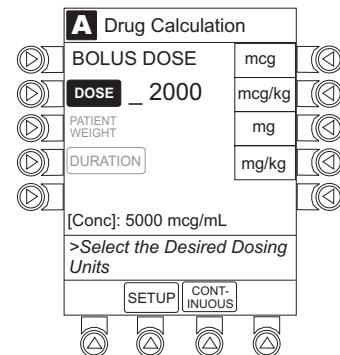

4. Press soft key next to appropriate unit of measure for dose. ①
5. To enter bolus duration, use numeric data entry keys.
 - **TOTAL DOSE** alternates with **INFUSE AT** rate.
6. Verify parameters are correct and press **START** soft key. ②

Infusion - NO Guardrails® Suite MX Protection (Continued)

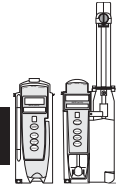

Bolus Dose (Continued)

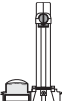
7.  Syringe Module: If bolus dose was programmed at beginning of infusion, attach administration set to patient. ^③

Stopping and Restoring Bolus Dose

See "Primary Infusion - With Guardrails® Suite MX Protection", "Bolus Dose" procedure.

NOTES:

- ① If **mcg** or **mg** is selected as the dosing unit, a **PATIENT WEIGHT** entry cannot be made. If **mcg/kg** or **mg/kg** is selected as the dosing unit, a **PATIENT WEIGHT** entry is required.
- ② To see details during the bolus infusion, press the **CHANNEL SELECT** key.
- ③ Syringe Module: Starting the infusion before attaching the administration set to the patient minimizes any potential bolus that can be released from pressure built up in the set due to normal syringe loading and priming.

Secondary Infusion - NO Guardrails® Suite MX Protection (Pump Module)



Introduction and Setup

See "Secondary Infusion - With Guardrails® Suite MX Protection".

Infusion

The following procedure should be used only when:

- drug to be infused is not listed in Drug Library,
- primary infusion is running, and
- a check valve administration set is being used.

Secondary Infusion - NO Guardrails® Suite MX Protection (Pump Module) (Continued)



Infusion (Continued)

To program a primary infusion, see "Primary Infusion - With Guardrails® Suite MX Protection", "IV Fluid Infusion" procedure.
To program a basic infusion, see "Infusion - NO Guardrails® Suite MX Protection".

1. Press **SECONDARY** soft key and then **BASIC SEC** soft key. Continue with next step.
2. Enter secondary infusion rate or duration, as follows:
 - To enter secondary infusion rate, press **RATE** soft key and use numeric data entry keys.
 - To enter duration, press **DURATION** soft key and use numeric data entry keys.
3. To enter secondary volume to be infused, press **VTBI** soft key and use numeric data entry keys.
4. Open clamp on secondary administration set.
5. Verify correct infusion parameters and press **START** soft key.

Changing Primary Infusion Parameter

1. Press **CHANNEL SELECT** key.
2. Press **PRIMARY** soft key.
3. To change primary infusion parameter, press applicable soft key (**RATE** or **VTBI**), and use numeric data entry keys.
4. Verify correct primary infusion parameters and press **SECONDARY** soft key.
 - Secondary setup screen displays.
5. To resume secondary infusion, press **START** soft key.

Stopping Secondary and Returning to Primary

See "Secondary Infusion - With Guardrails® Suite MX Protection".

Pausing, Changing, Restarting Infusion

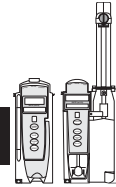

Pausing and Restarting Infusion ① ②

1. Press **PAUSE** key.
 - **PAUSE** scrolls in Message Display.
 - **PAUSED** appears on Main Display.
 - Yellow Standby Status Indicator illuminates.
 - After 2 minutes, **PAUSE-RESTART CHANNEL** visual and audio prompts begin, and yellow Standby Status Indicator flashes.

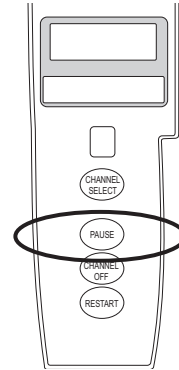

2. To reinitiate infusion:
 - Press **RESTART** key.
 - **OR**
 - Press **CHANNEL SELECT** key and then press **START** soft key.

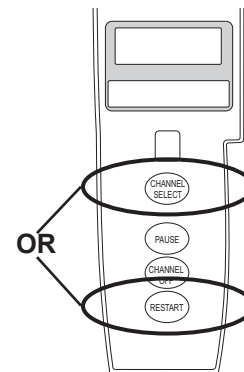

NOTES:

- ① To stop a Bolus Dose, see the "Bolus Dose" procedure.
- ② The Pump Module keypad is used in the illustrations but the keys are the same for the Syringe Module.

Changing Rate or VTBI During Infusion

1. Press **CHANNEL SELECT** key.
2. Press either **RATE** or **VTBI** soft key.
3. To enter desired parameter, use up/down arrows for rate titration, or numeric data entry keys.
4. Verify correct infusion parameter entry and press **START** soft key.

Pausing, Changing, Restarting Infusion (Continued)

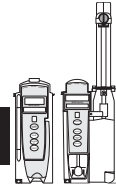

Restoring Infusion ^①

1. To restart infusion using stored parameters, press **RESTORE** soft key.
2. Verify parameters are valid and press **START** soft key.

NOTE:

- ^① To restore a Bolus Dose, see the "Bolus Dose" procedure.

Viewing and Clearing Volume Infused

1. To view volume infused, press **VOLUME INFUSED** soft key.
 - Total volume infused (primary + secondary), and time and date volume infused was last cleared, display for each module. ^{① ②}

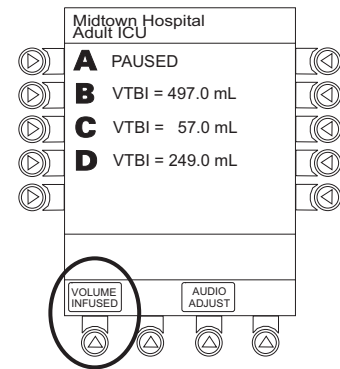
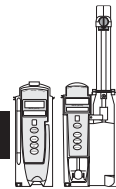

2.  To view primary and secondary volume(s) infused, press **PRI/SEC VOLUME** soft key.

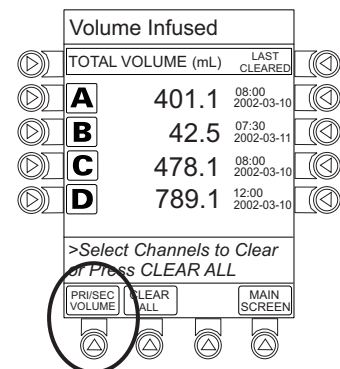

Viewing and Clearing Volume Infused (Continued)

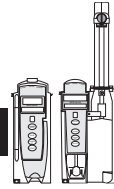

3. To clear volume infused: ③ ④

- If only selected module is to be cleared, press soft key next to applicable module(s) and press **CLEAR CHANNEL** soft key.
 - ◆ Volume clears on selected module(s).
- If all modules are to be cleared, press **CLEAR ALL** soft key.

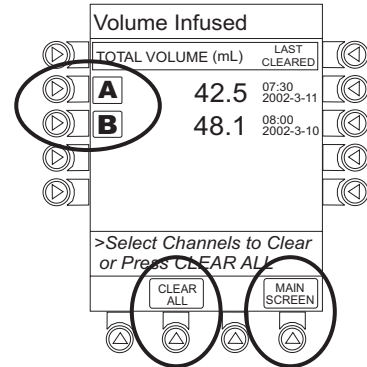

- To return to main screen, press **MAIN SCREEN** soft key.

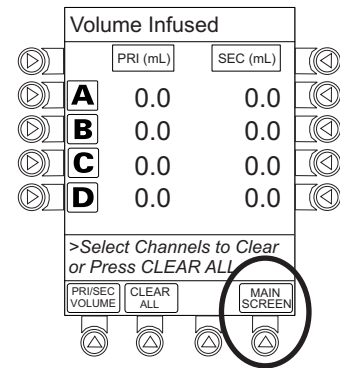

NOTES:

- ① Date format is year-month-day.
- ② Pump Module: A **PRI/SEC VOLUME** soft key is available to allow secondary volume infused to be displayed.
- ③ If no key is pressed, main screen appears after 30 seconds.
- ④ The illustrated example is a Syringe Module display. A Pump Module display has a **PRI/SEC VOLUME** soft key.

Channel Labels

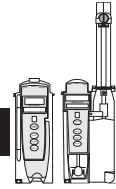

Selecting ^①

1. Press **CHANNEL SELECT** key.
2. Press **OPTIONS** key.
3. Syringe Module: Press **PAGE DOWN** soft key.

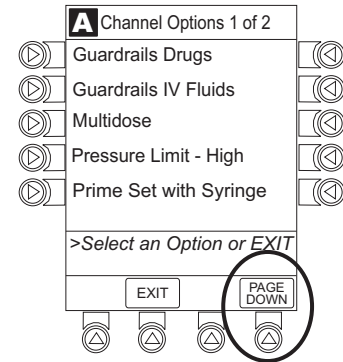
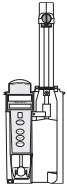

4. Press **Channel Labels** soft key.

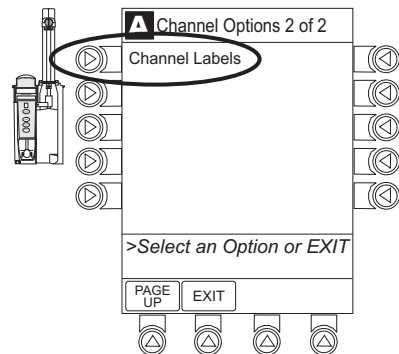
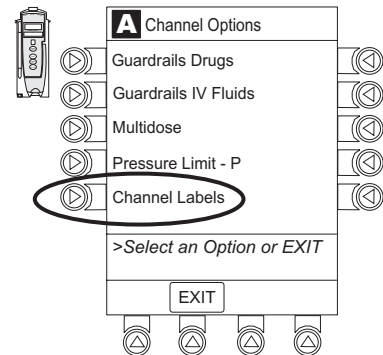

Channel Labels (Continued)

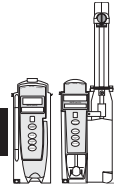

Selecting ^① (Continued)

5. Press soft key for desired label. ^②
 - Selected label is highlighted and scrolls in Message Display.

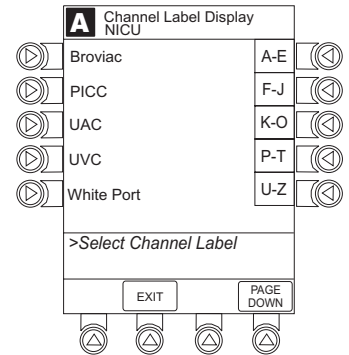

6. To continue infusion, press **START** soft key.
OR
Program infusion as previously described.

NOTES:

- ^① The **Channel Labels** option is not available if a **Guardrails IV Fluids** or **Guardrails Drugs** infusion is running on the module.
- ^② To view additional labels, press a soft key next to a letter group to navigate through alphabet, and/or **PAGE UP** and **PAGE DOWN** soft keys.

Channel Labels (Continued)

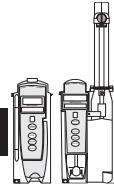

Removing ^①

1. Press **CHANNEL SELECT** key.
2. Press **OPTIONS** key.
3. Syringe Module: Press **PAGE DOWN** soft key.

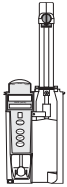

4. Press **Channel Labels** soft key.
5. Press **CLEAR LABEL** soft key.
 - Label stops scrolling in Message Display.

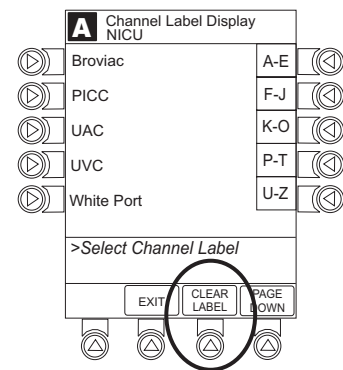

6. To begin infusion, press start soft key.
OR
Program infusion as previously described.

NOTE:

- ① A channel label is removed when the **Basic Infusion** is promoted to a **Guardrails IV Fluids** or **Guardrails Drugs** infusion.

Anesthesia Mode

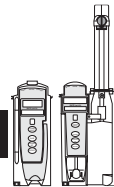

See the PC Unit Section of this DFU.

Delay Options

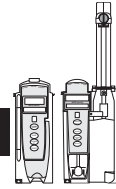

Delay Options can be enabled at the time the Alaris® System is configured for use. If Delay Options is enabled, a primary infusion can be programmed to be delayed for a specified period of time and a callback can be scheduled, as described in the following procedures.

Since by definition, an infusion with Delay Options infuses for a programmed period of time, it is assumed that another infusing IV line keeps the vein open until the delayed infusion begins. When a delay is programmed, the infusion stops when complete and no KVO is delivered.

Delaying Infusion

The delay period for an infusion can be programmed as a specific number of minutes or a time of day, as described in the following procedures. An infusion delay can be programmed prior to or after an infusion is initiated.

Specifying by Minutes

The **Delay for** option is used to program an infusion delay for a minimum of 1 minute and up to 120 minutes.

1. Press **DELAY OPTIONS** soft key.

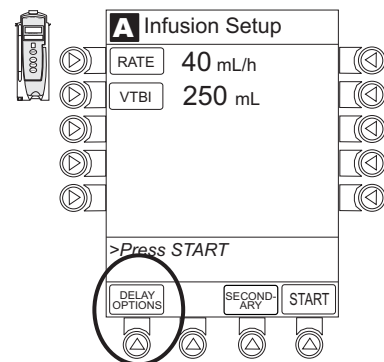

-- Continued on Next Page --

Delay Options (Continued)

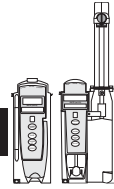

Delaying Infusion (Continued)

Specifying by Minutes (Continued)

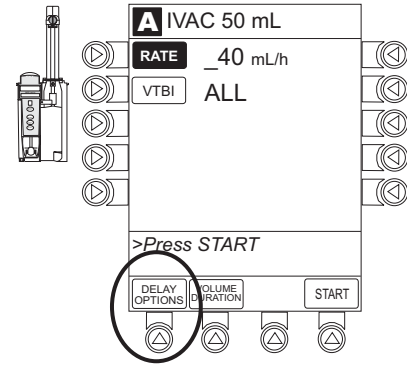

2. Press **Delay for** soft key.

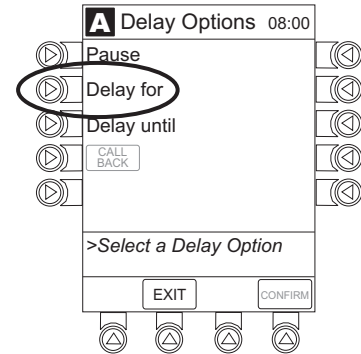

3. To enter number of minutes (up to 120) infusion is to be delayed for, use numeric data entry keys.
4. Press **CONFIRM** soft key.
 - Delay period counts down on Main Display.
 - If a **Before** callback has not been scheduled (see "Scheduling a Callback" procedure), infusion automatically initiates at end of delay period.

Delay Options (Continued)

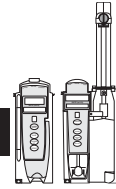

Delaying Infusion (Continued)

Specifying by Time of Day

The **Delay until** option is used to program an infusion delay for a minimum of 1 minute and up to 23 hours 59 minutes.

1. Press **DELAY OPTIONS** soft key.
2. Press **Delay until** soft key.

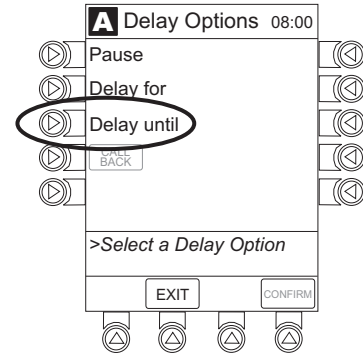

3. If **Current time** displayed is correct, press **CONFIRM** soft key; otherwise, press **Change Time** and enter correct time. (See "System Options", "Time of Day" in PC Unit Section of this DFU.)^①

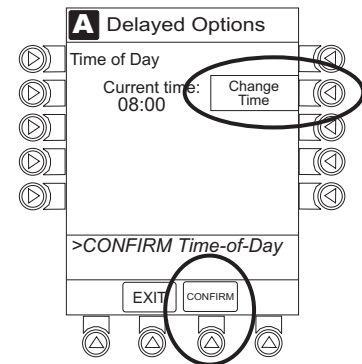

4. To enter time of day infusion is to be initiated (up to 23 hours 59 minutes), use numeric data entry keys.
5. Press **CONFIRM** soft key.
 - Time infusion is scheduled to start appears on Main Display.
 - If a **Before** callback has not been scheduled (see "Scheduling a Callback" procedure), infusion automatically initiates at end of delay period.

NOTE:

- ^① If the current time has been previously confirmed, the **Time of Day** screen is not displayed.

Delay Options (Continued)

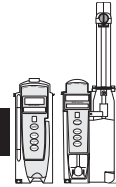

Scheduling a Callback

When programming a **Delay for** or **Delay until** infusion, a callback can be scheduled for that infusion. There are three types of callback:

- **Before** - gives an alert when delay period is completed and infusion needs to be initiated.
- **After** - gives an alert when delayed infusion has completed.
- **Before and After** - gives an alert when delay period is completed and infusion needs to be initiated and when delayed infusion has completed.

The default callback (**None**), or the callback for the current profile, appears on the Main Display. To schedule a different callback:

1. Prior to pressing **CONFIRM** soft key to initiate delay during **Delay for** or **Delay until** programming process, press **CALL BACK** soft key.
2. Press soft key corresponding to desired callback option.
 - Scheduled callback appears on Main Display.
3. To initiate delay, press **CONFIRM** soft key.
 - If **Delay until** programming, time infusion is scheduled to start appears on Main Display.
OR
If **Delay for** programming, delay period counts down on Main Display.
 - If **Before** option was selected:
 - ♦ An audio prompt sounds when delay period has ended.
 - ♦ Yellow Standby Status Indicator flashes.
 - ♦ **DELAY COMPLETE** scrolls in Message Display and appears on Main Display.

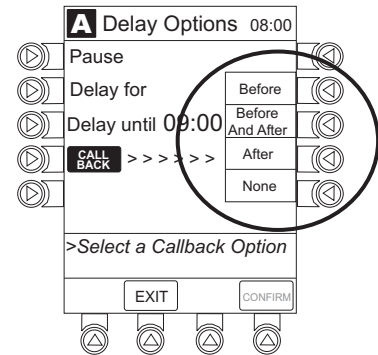

-- Continued on Next Page --

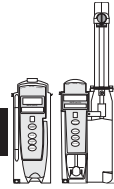

Delay Options (Continued)

Scheduling a Callback (Continued)

- If **After** option was selected:
 - ◆ An audio prompt sounds when delayed infusion completes, and continues to sound until responded to.
 - ◆ Yellow Standby Status Indicator flashes until audio is silenced.
 - ◆ Infusion completed message appears on Main Display.
 - ◆ **Infusion Complete** scrolls in Message Display.
 - If **Before and After** option was selected, same prompts and indicators mentioned above for both **Before** and **After** options are exhibited.
4. To respond to a callback:
- **Before** callback
Press **CHANNEL SELECT** key and then **START** soft key.
 - OR**
 - Press **RESTART** key.
 - **After** callback: Press **CONFIRM** soft key.
 - **Before and After** callback: Respond as indicated above for both **Before** and **After**.

Pausing Infusion

1. Press **DELAY OPTIONS** soft key.
2. Press **Pause** soft key. ① ②

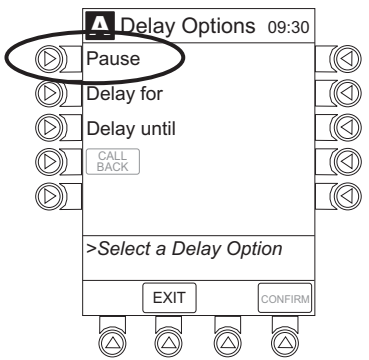

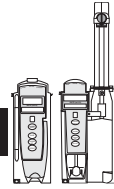

Delay Options (Continued)

Pausing Infusion (Continued)

3. Press **CONFIRM** soft key.
 - **PAUSE** scrolls in Message Display.
 - **PAUSED** appears on Main Display.
 - Yellow Standby Status Indicator illuminates.
 - After 2 minutes: **PAUSE - RESTART CHANNEL** visual and audio prompts begin, and yellow Standby Status Indicator flashes.
4. To reinitiate infusion:
 - Press **RESTART** key.
 - OR**
 - Press **CHANNEL SELECT** key and then **START** soft key.

NOTES:

- ① Using the **Pause** function in the Delay Options screen is the same as pressing the **PAUSE** key on the Syringe Module.
- ② The time displayed in the upper right corner of the screen is the time of day in a 24-hour clock format (military time).

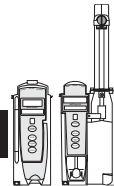

Multidose Mode

Since, by definition, a multidose infusion does not infuse for a programmed period of time, it is assumed that another infusing IV line keeps the vein open until the beginning of the first dose and between subsequent doses. There is no keep vein open (KVO) infusion at the completion of a programmed **Delay until** infusion.

Syringe Module: ALL Mode is not supported in Multidose Mode.

WARNINGS

- The Multidose feature is to be used only by **personnel properly trained** in using multidose infusions.
- **Caution labels**, which clearly differentiate single dose and multidose containers, must be utilized.
- Single dose piggybacking systems employing **check valve sets** are not designed for use with multidose containers.



Multidose Mode (Continued)

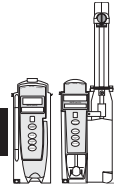

The Delay Options function for multidose infusions is similar to Delay Options for continuous drug infusions, with the following differences:

- **Delay for** option (when scheduling a callback) is not available in Multidose Mode.
 - Maximum allowable delay on a multidose infusion is 8 hours.
1. Press **CHANNEL SELECT** key.
 2. Press **OPTIONS** key.
 3. Press **Multidose** soft key.

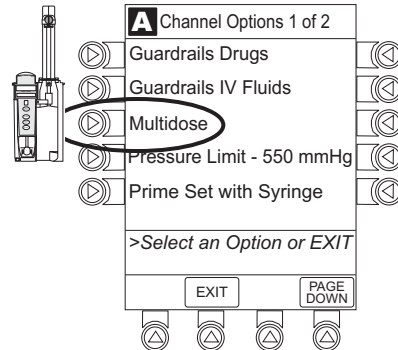
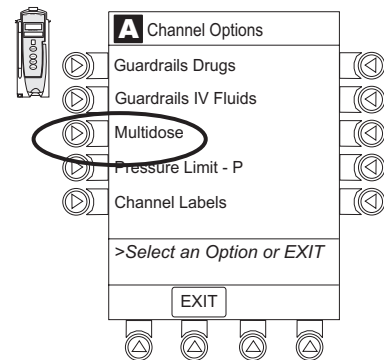

4. Start applicable infusion, as described in following procedures:

Volume/Duration Enabled
Volume/Duration Disabled

Multidose Mode (Continued)

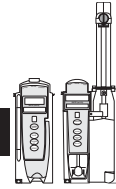

Volume/Duration Enabled

1. If **Current time** displayed is correct, press **CONFIRM** soft key; otherwise, press **Change Time** and enter correct time. (See "System Options", "Time of Day" in PC Unit Section of this DFU.)^①

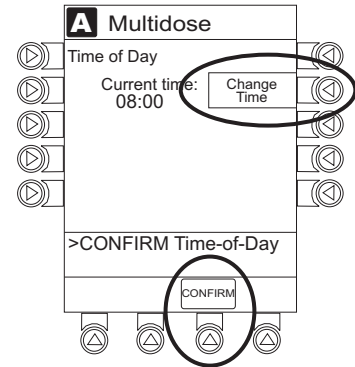

2. Press **VOLUME DURATION** soft key.
3. To enter volume to be infused for each dose, use numeric data entry keys.
4. To enter duration for each dose, press **DURATION** soft key and use numeric data entry keys.^②
5. To enter time interval (1 to 24 hours) between doses, press **DOSE INTERVAL** soft key and use numeric data entry keys.
6. To enter number of doses, press **# OF DOSES** soft key and use numeric data entry keys.
 - If Delay Options is enabled, **DELAY OPTIONS** soft key appears.^③
7. To begin multidose infusion, press **START** soft key.
 - Main Display shows remaining VTBI for that dose.
 - At completion of a multidose program, **MULTIDOSE COMPLETE** appears on Main Display.^④
8. Syringe Module: Attach administration set to patient.^⑤

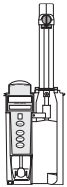

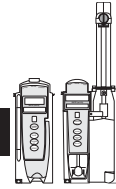

Multidose Mode (Continued)

Volume/Duration Enabled (Continued)

9. To see detail screen during or between infusions, press **CHANNEL SELECT** key.
 - During infusion, **Volume Remaining** displays.
 - Between infusions:
 - ◆ Number of doses completed and when next dose starts display.
 - ◆ Yellow Standby Status Indicator illuminates.

NOTES:

- ① If the current time has been previously confirmed, the **Time of Day** screen is not displayed.
- ② **RATE** is calculated with each keystroke for **DURATION**.
- ③ See "Delay Options" procedure to program an infusion delay. When delaying an infusion, a multidose cannot be delayed for more than 8 hours, and all doses in the multidose program must be completed within a 24-hour program.
- ④ Syringe Module: If NEOI is enabled, the Near End of infusion message appears near the end of the last dose.
- ⑤ Syringe Module: Starting the infusion before attaching the administration set to the patient minimizes any potential bolus that can be released from pressure built up in the set due to normal syringe loading and priming.

Volume/Duration Disabled

1. To enter rate, use numeric data entry keys.
2. To enter volume to be infused for each dose, press **VOLUME/DOSE** soft key and use numeric data entry keys.
3. To enter time interval (1 to 24 hours) between doses, press **DOSE INTERVAL** soft key and use numeric data entry keys.
4. To enter number of doses, press **# OF DOSES** soft key and use numeric data entry keys.
 - If Delay Options is enabled, **DELAY OPTIONS** soft key appears. ^①

Multidose Mode (Continued)

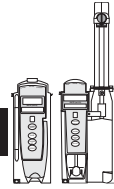

Volume/Duration Disabled (Continued)

5. To begin multidose infusion, press **START** soft key.
 - Main Display shows remaining VTBI for that dose.
 - At completion of a multidose program, **MULTIDOSE COMPLETE** appears on Main Display. ^②
6.  Syringe Module: Attach administration set to patient. ^③

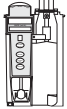

7. To see detail screen during or between infusions, press **CHANNEL SELECT** key.
 - During infusion, **Volume Remaining** displays.
 - Between infusions:
 - ◆ Number of doses completed and when next dose starts displays.
 - ◆ Yellow Standby Status Indicator illuminates.

NOTES:

- ① See "Delay Options" procedure to program an infusion delay. When delaying an infusion, a multidose cannot be delayed for more than 8 hours, and all doses in the multidose program must be completed within a 24-hour program.
- ② Syringe Module: If NEOI is enabled, the Near End of infusion message appears near the end of the last dose.
- ③ Syringe Module: Starting the infusion before attaching the administration set to the patient minimizes any potential bolus that can be released from pressure built up in the set due to normal syringe loading and priming.

Selecting Pressure Limit

Pump Module



1. Press **CHANNEL SELECT** key.
2. Press **OPTIONS** key.

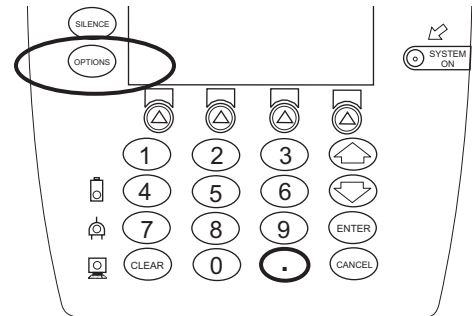

3. Press **Pressure Limit** soft key.

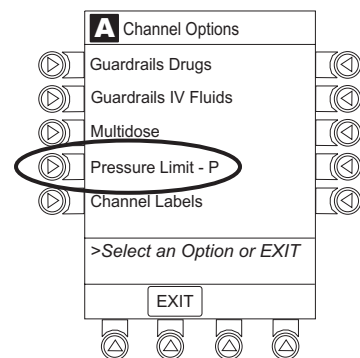

4. Press either **Pump** or **Selectable** pressure soft key. If **Selectable** is pressed, continue with next step; otherwise, proceed to last step.

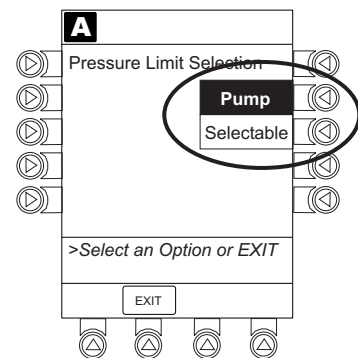

Selecting Pressure Limit (Continued)

Pump Module (Continued)



- To select occlusion pressure limit, press either **Up** or **Down** soft key.
- Verify correct occlusion pressure limit input and press **CONFIRM** soft key.

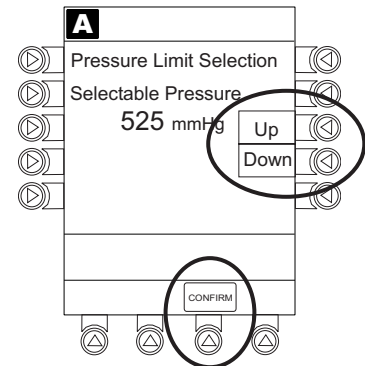

- Press **START** soft key.



Syringe Module

Pressure Sensing Disc Installed

- Ensure pressure sensing disc is installed correctly.
- Press **CHANNEL SELECT** key.
- Press **OPTIONS** key.

WARNING

Installing a pressure sensing disc after an infusion has started can result in a bolus to the patient.

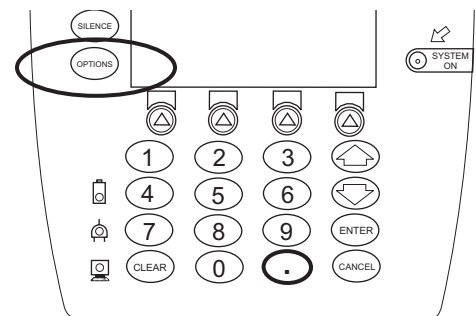

Selecting Pressure Limit (Continued)

Syringe Module (Continued)



Pressure Sensing Disc Installed (Continued)

4. Press **Pressure Limit** soft key.

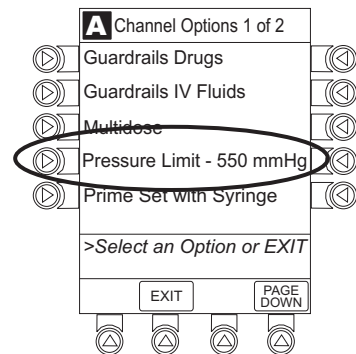

5. To enter a new pressure limit value, press **Change Value** soft key.

OR

If Auto Pressure feature is enabled, press **Auto Pressure** soft key. ^①

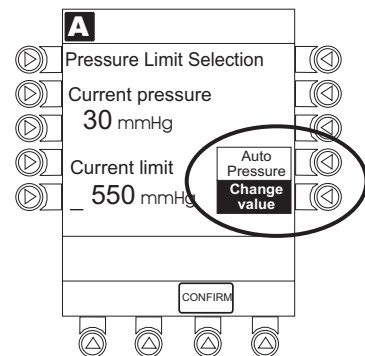

6. Verify correct pressure limit input and press **CONFIRM** soft key.

Pressure Sensing Disc NOT Installed

1. Press **CHANNEL SELECT** key.
2. Press **OPTIONS** key.

Selecting Pressure Limit (Continued)

Syringe Module (Continued)



Pressure Sensing Disc NOT Installed (Continued)

3. Press **Pressure Limit** soft key.

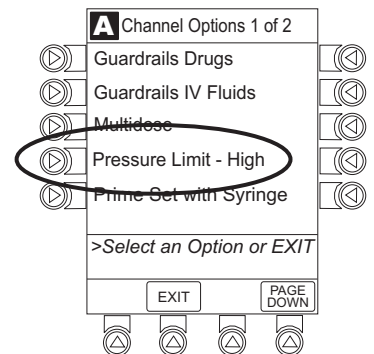

4. To select a pressure limit, press appropriate soft key.

5. Press **CONFIRM** soft key.

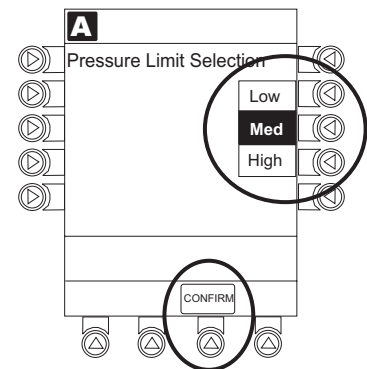

NOTE:

- ① If Auto Pressure is selected and current pressure is:
 - 100 mmHg or less – system adds 30 mmHg to current pressure, to create a new alarm limit
 - greater than 100 mmHg – system adds 30% to current pressure, to create a new alarm limit

System Start-Up / Setup

See the PC Unit Section of this DFU, "General Setup and Operation", for various system start-up and setup procedures.

Setting Up for Gravity Infusion (Pump Module)



1. Prime administration set (see "Getting Started", "Priming" procedure).
2. Adjust container to hang 20 inches above patient's vascular access device.
3. Attach administration set to patient's vascular access device.
4. Adjust flow rate with administration set roller clamp.

Changing Solution Container (Pump Module)



1. To stop infusion, press **PAUSE** key.
2. Close roller clamp.
3. Remove empty solution container.
4. Insert administration set spike into prepared fluid container, following accepted hospital/facility procedure, and hang container 20 inches above Pump Module.
5. Press **CHANNEL SELECT** key.
6. To enter VTBI, press **VTBI** soft key and use numeric data entry keys.
7. Open roller clamp.
8. To resume infusion, press **START** soft key.

Changing Syringe During Infusion (Syringe Module)



If a critical medication is being infused at a flow rate less than 1.0 mL/h and the patient is not stable enough to experience even a short period of time without the drug, it is recommended that the new syringe and administration set be installed as part of a second Alaris® System setup. Before changing the infusion line at the patient end, start the infusion and wait for fluid to drip from the end of the tubing.

1. To stop infusion, press **PAUSE** key.
2. Open plunger grippers and syringe barrel clamp.
 - An audio prompt sounds (to silence, press **SILENCE** key).
 - Red Alarm Status Indicator flashes.
 - **CHECK SYRINGE** scrolls in Message Display.
3. Remove syringe and separate administration set from syringe.
4. Reattach administration set to new syringe and load new syringe (see "Getting Started").
5. Select syringe type and size (see "Programming", "Primary Infusion - With Guardrails® Suite MX Protection").
6. Press **CONFIRM** soft key.
7. Prime administration set (see "Getting Started", "Priming - Using Options Menu" or "Priming - Manual" procedure).
8. Press **RESTORE** soft key.
OR
To enter VTBI and rate, press **RATE** soft key and use numeric data entry keys, and then **VTBI** soft key and use numeric data entry keys.
9. To begin infusion, press **START** soft key.

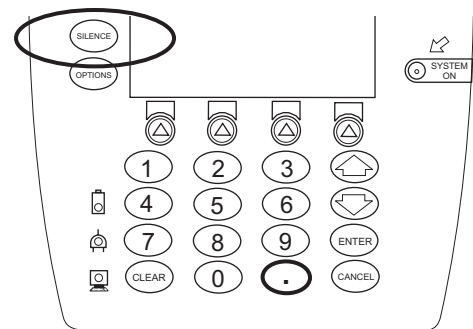

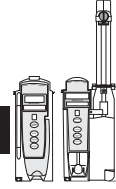

Warnings and Cautions

General

WARNINGS

- The Pump and Syringe Modules are designed to **stop fluid flow under alarm conditions**. Periodic patient monitoring must be performed to ensure the infusion is proceeding as expected. It is a **positive displacement delivery system**, capable of developing positive fluid pressures to overcome widely varying resistances to flow encountered in practice, including resistances to flow imposed by small gauge catheters, filters and intra-arterial infusion. It is neither designed nor intended to detect infiltrations and does not alarm under infiltration conditions.
- The use of positive displacement infusion devices ported together with **gravity flow infusion** systems into a common IV site may impede the flow of common "gravity only" systems, affecting their performance. Hospital/facility personnel must ensure the performance of the common IV site is satisfactory under these circumstances.
- To prevent a **potential free-flow condition**, ensure no extraneous object (for example, bedding, tubing, glove) is enclosed or caught in the Pump Module door.



Administration Sets

WARNINGS





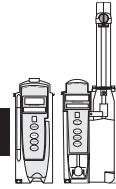

- **When priming:**
 - ◆ Ensure administration set is not connected to patient.
 - ◆ Ensure air is expelled from line prior to beginning infusion (unexpelled air in line could have serious consequences).Failure to prime correctly can delay infusion delivery and cause the total volume to be infused to read higher than the actual total delivered to the patient.
- **Discard if** packaging is not intact or protector caps are unattached.

Warnings and Cautions (Continued)



Administration Sets (Continued)

WARNINGS

- Use only **Pump Module/Gemini Infusion System administration sets** with the Pump Module. The use of any other set may cause improper instrument operation, resulting in an inaccurate fluid delivery or other potential hazard. For a list of compatible sets, reference the Set Compatibility Card (provided separately). 
- Use only standard single-use disposable syringes (with luer-lock connectors) and administration sets, designed for use on syringe pumps, with the Syringe Module. The use of any other **syringe or administration set** may cause improper instrument operation, resulting in an inaccurate fluid delivery or pressure sensing, or other potential hazards. For a list of compatible syringes, see "Compatible Syringes". For a list of compatible sets, reference the Set Compatibility Card (provided separately). 
- **Before loading or unloading the syringe**, always turn off fluid flow to the patient, using the tubing clamp or stopcock. Uncontrolled fluid flow can occur when the administration set is not clamped or turned off, and may cause serious injury or death. 
- When the **pressure sensing disc is not being used** and an occlusion occurs, there is a risk of infusing pressurized buildup of infusates upon correction of the occlusion. To avoid an inadvertent bolus, relieve the pressure before restarting the infusion. 
- Ensure the displayed **syringe manufacturer and syringe size** correctly identify the installed syringe. Mismatches may cause an under-infusion or over-infusion to the patient that could result in serious injury and/or death. For a list of compatible syringes, see "Compatible Syringes". 
- **Installing a pressure sensing disc** after an infusion has started can result in a bolus to the patient. 

CAUTION

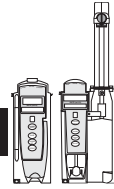

Before operating instrument, verify that administration set is **free from kinks and installed correctly** in instrument.

Warnings and Cautions (Continued)



Epidural Administration

WARNINGS

- **Epidural administration** of drugs other than those indicated for epidural use could result in serious injury to the patient.
- It is strongly recommended that the source container, administration set, and Pump Module used for **epidural drug delivery** be clearly differentiated from those used for other types of administration. 
- It is strongly recommended that the syringe, administration set and Syringe Module used for **epidural drug delivery** be clearly differentiated from those used for other types of administration. 
- The Alaris® System can be used for epidural administration of **anesthetic and analgesic drugs**. This application is only appropriate when using anesthetics and analgesics labeled for continuous epidural administration and catheters intended specifically for epidural use. Use only a Pump Module/Gemini Infusion System administration set or syringe set, without a 'Y' connector or injection port, for epidural infusions.
 - ◆ Epidural administration of **anesthetic drugs**: Use indwelling catheters specifically indicated for short-term (96 hours or less) anesthetic epidural drug delivery.
 - ◆ Epidural administration of **analgesic drugs**: Use indwelling catheters specifically indicated for either short-term or long-term analgesic epidural drug delivery.

Warnings and Cautions (Continued)

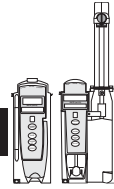

Guardrails® Suite MX

WARNINGS

- The **Guardrails® Suite MX** incorporates dosing limits and instrument configuration parameters based on hospital/facility protocol. The software adds a **test of reasonableness** to drug programming based on the limits defined by the hospital/facility. Qualified personnel must ensure the appropriateness of drug dosing limits, drug compatibility, and instrument performance, as part of the overall infusion. **Potential hazards** include drug interactions, inaccurate delivery rates and pressure alarms, and nuisance alarms.
- When loading a **Data Set** with the Guardrails® Suite MX, **ensure the correct profile** (for patient care area) is selected prior to starting an infusion. Failure to use the appropriate profile could cause serious consequences.

Administration Set / Syringe Information

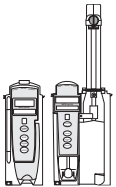

Infusion Modules:

- For specific administration set instructions and replacement interval, reference directions for use provided with set.
- For a list of compatible administration sets, reference Set Compatibility Card (provided separately).
- Use aseptic techniques when handling sets and syringes.
- Administration sets are supplied with a sterile and nonpyrogenic fluid path for one-time use. Do not resterilize.
- Discard administration set per facility protocol.
- For IV push medication (put instrument on hold), clamp tubing above port.
- Flush port(s) per facility protocol.

Administration Set / Syringe Information (Continued)



The Pump Module uses a wide variety of Pump Module/Gemini Infusion System administration sets. The sets are designed for use with the Pump Module as well as for gravity-flow, stand-alone use.

- Primary set must be primed before use. It can be loaded into Pump Module to deliver a large volume infusion or it can be set up to deliver a gravity infusion.
- Safety clamp fitment (referred to on device as "Flo-Stop") is a unique clamping device on the pumping segment that is part of all Pump Module/Gemini Infusion System sets (see "Safety Clamp Fitment").



The Syringe Module uses standard, single-use, disposable syringes (with luer-lock connectors) and administration sets, designed for use on syringe pumps.

- For a list of compatible syringes, see "Compatible Syringes".

SmartSite® Infusion Set (Pump Module)



1. Prior to every access, swab top of Needle-Free Valve port with 70% isopropyl alcohol (1 - 2 seconds) and allow to dry (approximately 30 seconds).^①
2. Prime valve port. If applicable, attach syringe to Needle-Free Valve port and aspirate miniscule air bubbles.
3. Replace every 72 hours or after 100 activations, whichever occurs first. For infusions of blood, blood products or lipid emulsions, replace every 24 hours.

CAUTIONS

- If the Needle-Free Valve is **accessed by a needle** in an emergency, the valve will be damaged, causing leakage. Replace Needle-Free Valve immediately.
- The Needle-Free Valve is **contraindicated** for blunt cannula systems.
- Do not leave **slip luer syringes** unattended.

NOTE:

- ^① Dry time is dependent on area temperature, humidity and ventilation.

Administration Set / Syringe Information (Continued)

Safety Clamp Fitment (Pump Module) ^①



The primary administration set's safety clamp fitment is a unique clamping device, on the pumping segment, that prevents inadvertent free-flow when the administration set is removed from the instrument.

Safety Clamp Fitment in Open Position

When a new Pump Module/Gemini Infusion System administration set is removed from the package, the safety clamp fitment is in the open position (white slide clamp aligned with blue fitment). In this open position, flow is not occluded but is allowed as required for the priming process. The roller clamp is used to control flow during the priming process.

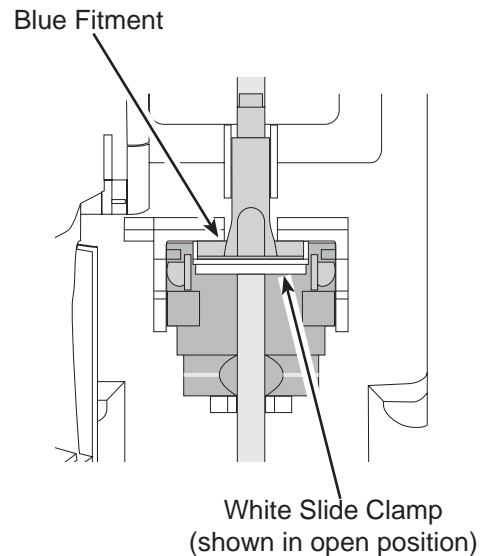

Safety Clamp Fitment in Closed Position

When a Pump Module/Gemini Infusion System administration set is removed from the Pump Module, the instrument automatically engages the safety clamp fitment in the closed position (white slide clamp projects out from under blue fitment). In this closed position, flow is occluded.

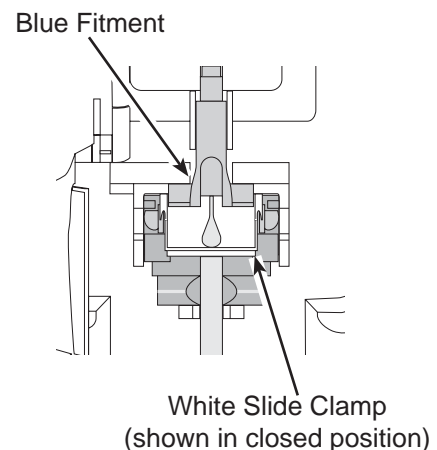

NOTE:

^① "Safety clamp" is referred to on the device as "Flo-Stop".

Administration Set / Syringe Information (Continued)

Compatible Syringes (Syringe Module)



The Syringe Module is calibrated and labeled for use with the following single-use disposable luer-lock syringes. Use only the syringe size and type specified on the Main Display. The full list of permitted syringe models is dependent on the Syringe Module's software version.

CAUTION

When using a **10 mL or smaller syringe**, Cardinal Health strongly recommends using an extension set with a pressure disc, for improved pressure monitoring and shorter times to occlusion alarm.

Manufacturer	1 mL	3 mL	5 mL	6 mL	10 mL	12 mL	20 mL	30 mL	35 mL	50 mL	60 mL
AstraZeneca										x ^①	x ^①
B-D Plastipak	x	x	x		x		x	x		x	x
IVAC										x	
Monoject		x ^②		x		x	x		x		x
Terumo		x	x ^③			x ^③	x	x		x	x

NOTES:

- ① Prefilled Diprivan.
- ② The Monoject SoftPack Luer-Lock Syringe (blister pack) is the only currently supported Monoject 3 mL.
- ③ The Terumo 5 mL can also be used as a 6 mL and the 10 mL as a 12 mL.

Features and Displays

Features and Definitions

See the PC Unit Section of this DFU for system features and definitions.

Pump and Syringe Modules

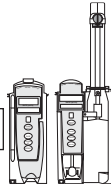

Anesthesia Mode

When operating in Anesthesia Mode, a module can be paused indefinitely without an alarm. Anesthesia Mode also makes it possible to have additional drugs in each profile, which are only accessible when operating in that mode.

Bolus Dose

Allows a bolus infusion to be programmed using either Drug Library or drug calculation feature. It can be programmed with or without a continuous infusion following a bolus.

Callback

A callback for a programmed delay (see "Delay Options" definition) can be scheduled to give an alert **Before** an infusion is to be initiated, **After** an infusion is completed, **Before and After** an infusion, or no alert (**None**).

Channel Labels

Available when Profiles feature is enabled. It provides a hospital-defined list of labels, displayed in Channel (module) Message Display, and identifies module with catheter location or other helpful information.

Concentration Limits

Limits specified for range of concentrations allowed for a particular drug in a profile.

Delay Options

Allows system to be programmed to delay start of an infusion **a)** for up to 120 minutes or **b)** for a specific time up to 23 hours 59 minutes.

Dose Checking

Always Dose Checking option causes an Alert to occur each time a dose limit is exceeded. Drug label in Message Display provides an indicator ("↑↑↑" or "LLL") that dose is beyond current Soft Limit.

Smart Dose Checking option causes an initial soft Alert to occur when a dose limit is exceeded. Subsequent programming beyond dose limit does not receive an Alert. Drug label in Message Display provides an indicator ("↑↑↑" or "LLL") that dose is beyond current Soft Limit.

Features and Displays (Continued)

Features and Definitions (Continued)

Pump and Syringe Modules (Continued)



Drug Calculation

Allows:

- entry of drug dose for a continuous infusion (Alaris® System calculates correct flow rate to achieve desired dose),
- OR**
- entry of flow rate for a continuous infusion (Alaris® System calculates corresponding drug dose).

Drug Library

When Profiles feature is enabled, it provides a hospital-defined list of drugs and concentrations appropriate for use in as many as 10 profiles. Drug Library use automates programming steps, including drug name, drug amount and diluent volume, and activates hospital-established best-practice limits. Drug Library entries can be delivered as a primary or secondary, or both, as determined by hospital-health system.

Duration Limits

Hospital-established limits around duration of infusion.

Dynamic Pressure Display

Appears on Main Display. If enabled, it graphically displays current patient-side occlusion pressure set point and current patient-side operating pressure for that module. (See "Displays" for additional "Dynamic Pressure Display" information.)

Event Logging

Event Logging records instrument operations.

Initial Value

An optional and editable starting value for continuous infusion dose, duration, bolus dose, bolus rate of administration or bolus dose duration.

IV Fluid Library

An optional library consisting of IV Fluids (for example, TPN) and Limits around rate of delivery.

Features and Displays (Continued)

Features and Definitions (Continued)

Pump and Syringe Modules (Continued)

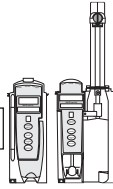

Limit

A programming Limit or best-practice guideline determined by hospital/health system and entered into system's Data Set. Supports concentration Limits for all infusions that utilize concentration. Profile-specific Limits can be defined for flow rate, patient weight, body surface area (BSA), maximum and minimum continuous dose, or total dose and duration for each drug in a Drug Library. Dose and duration Limits can be defined by hospital/health system as Hard and/or Soft Limits.

- A Hard Limit is a programmed Limit that cannot be overridden, except in anesthesia mode.
- A Soft Limit is a programmed Limit that can be overridden.

Multidose Mode

Allows 2 - 24 doses to be programmed at equally spaced intervals on the same module over a 24-hour period. This mode is designed to allow delivery of multiple, equal doses from the same IV container at regularly scheduled intervals.

Rapid Bolus

Fastest rate at which bolus dose should be delivered, as defined by facility's clinical best-practice guidelines.

Restore

To simplify programming, can be used to recall previous rate and volume settings for same patient. This option is only available if patient is not new and system is powered up within 8 hours of last usage.

Therapies

An optional hospital-defined therapy or clinical indication for delivery of that infusion. Different Limits can be defined for same medication with different therapeutic indications.

Total Dose Limits

Hospital-established Limits around total dose of infusion.

Volume/Duration

Allows a volume-to-be-infused (VTBI) and duration (infusion time) to be programmed. Flow rate is automatically calculated.

Features and Displays (Continued)

Features and Definitions (Continued)

Pump Module



Auto-Restart

Part of Alaris® System's Downstream Occlusion Detection system designed to minimize nuisance, patient-side occlusion alarms. Allows system to automatically continue an infusion following detection of a patient-side occlusion if downstream pressure falls to an acceptable level within a 15-second "Checking Line" period. If this feature is enabled, "Checking Line" function occurs when downstream pressure exceeds pressure limit.

- In Selectable Pressure Mode: Pressure limit is either user-adjustable or "locked" in system configuration.
- In Pump Pressure Mode: Pressure limit is a function of flow rate and is automatically determined by device.

If downstream pressure decreases to a predetermined level, (below 50% of pressure limit) during 15-second "Checking Line" period, infusion automatically continues. If condition is not cleared within 15 seconds, a "Partial Occlusion - Patient Side" alarm occurs.

Using Editor Software, system can be configured to allow 0 (zero) to 9 restart attempts within a rolling 10 minute period. If allowable number of restarts is exceeded or if feature is set to zero, an "Occluded - Patient Side" alarm occurs when system detects downstream pressure that exceeds pressure limit.

Default Occlusion Pressure

Starting occlusion pressure limit which can be configured by profile in 25 mmHg increments.

Free Flow Protection

All Pump Module/Gemini Infusion System administration sets utilize a unique clamping device (safety clamp^① on pumping mechanism) to prevent inadvertent free-flow when administration set is removed from instrument.

NOTE:

- ① "Safety clamp" is referred to on the device as "Flo-Stop".

KVO Rate Adjust

Used to select KVO (Keep Vein Open) rate (0.1 to 20 mL/h allowed), which is rate of fluid flow after an "Infusion Complete" occurs. KVO rate never exceeds infusion rate.

Features and Displays (Continued)

Features and Definitions (Continued)

Pump Module (Continued)



Occlusion Pressure

A complete range of downstream occlusion detection options is provided.

- **Pump mode:** Downstream occlusion alarm threshold is 525 mmHg at flow rates of 30 mL/h or greater. For rates <30 mL/h, occlusion pressure is rate-dependent, to ensure rapid response to occlusions.
- **Selectable pressure mode:** Downstream occlusion alarm threshold can be adjusted in 25 mmHg increments, up to maximum occlusion pressure of 525 mmHg.
- **Auto-Restart:** (See "Auto-Restart" definition.)

In addition, Alaris® System provides fluid-side occlusion detection.

Secondary Infusions

Dual rate sequential piggyback (secondary) infusions may be infused, with limits, at delivery rates and volumes independent of primary infusion parameters. Automatic changeover occurs to primary infusion parameters when secondary infusion is complete if a Pump Module/Gemini Infusion System check valve administration set is used.

Syringe Module



All Mode

When **ALL** is selected as volume to be infused (VTBI), entire contents of syringe is delivered.

Auto Pressure

When enabled and a pressure sensing disc is in use, Auto Pressure option is displayed in Pressure Limit screen. Auto Pressure automatically sets alarm limit for a shorter time to alarm, as follows:

- If current pressure is 100 mmHg or less, system adds 30 mmHg to current pressure, to create a new alarm limit.
- If current pressure is greater than 100 mmHg, system adds 30% to current pressure, to create a new alarm limit.

Auto Pressure Limit Adjustment

When a bolus is delivered, pressure alarm limits are temporarily raised to maximum limit.

Features and Displays (Continued)

Features and Definitions (Continued)

Syringe Module (Continued)



Auto Syringe Size Identification	System automatically detects syringe size and narrows down syringe selection list.
Back Off	This feature is only available when administration set in use has a pressure sensing disc. When enabled, motor reverses plunger movement during an occlusion until pressure returns to preocclusion levels, automatically reducing bolus flow.
Fast Start	When Fast Start is enabled and an administration set having a pressure sensing disc is used, instrument runs at an increased rate when an infusion is first started, taking-up any slack in drive mechanism.
Infusion Complete	An alert is given when current infusion is complete and VTBI has reached zero.
Near End of Infusion (NEOI)	Allows an alert to be configured to sound anywhere from 1 to 60 minutes before infusion is complete. Alert occurs at configured time or when 25% of VTBI remains, whichever comes later.
Occlusion Pressure	<p>A complete range of downstream occlusion detection options is provided.</p> <ul style="list-style-type: none">• With pressure sensing disc: Downstream occlusion alarm threshold is selectable between 25 and 1000 mmHg, in 1 mmHg increments.• Without pressure sensing disc: Downstream occlusion alarm threshold can be set to low, medium, or high.
Pressure Sensing Disc	<p>When installed, pressure sensing disc significantly improves instrument's pressure sensing capabilities for a faster occlusion detection time, and makes following features available:</p> <p>Auto Pressure Back-Off Customizable Pressure Alarm Settings (see "Occlusion Pressure") Fast Start Pressure Tracking</p>
Pressure Tracking	Dynamic current pressure display is only available when pressure sensing disc is inserted.

Features and Displays (Continued)

Features and Definitions (Continued)

Syringe Module (Continued)



Priming

Allows a limited volume of fluid to be delivered in order to prime administration set prior to being connected to a patient or after changing a syringe. When priming, a single continuous press of **PRIME** soft key delivers up to 2 mL of priming fluid.

Selectable KVO

Allows some infusions to automatically switch into KVO mode upon completion. KVO option setting cannot be changed after instrument is powered on and a profile selected.

Syringe Empty

Instrument gives an alert and stops when an empty syringe is detected.

Syringe Volume Detection

System automatically detects fluid volume in a syringe when it is inserted.

Features and Displays (Continued)

Operating Features, Controls, Indicators

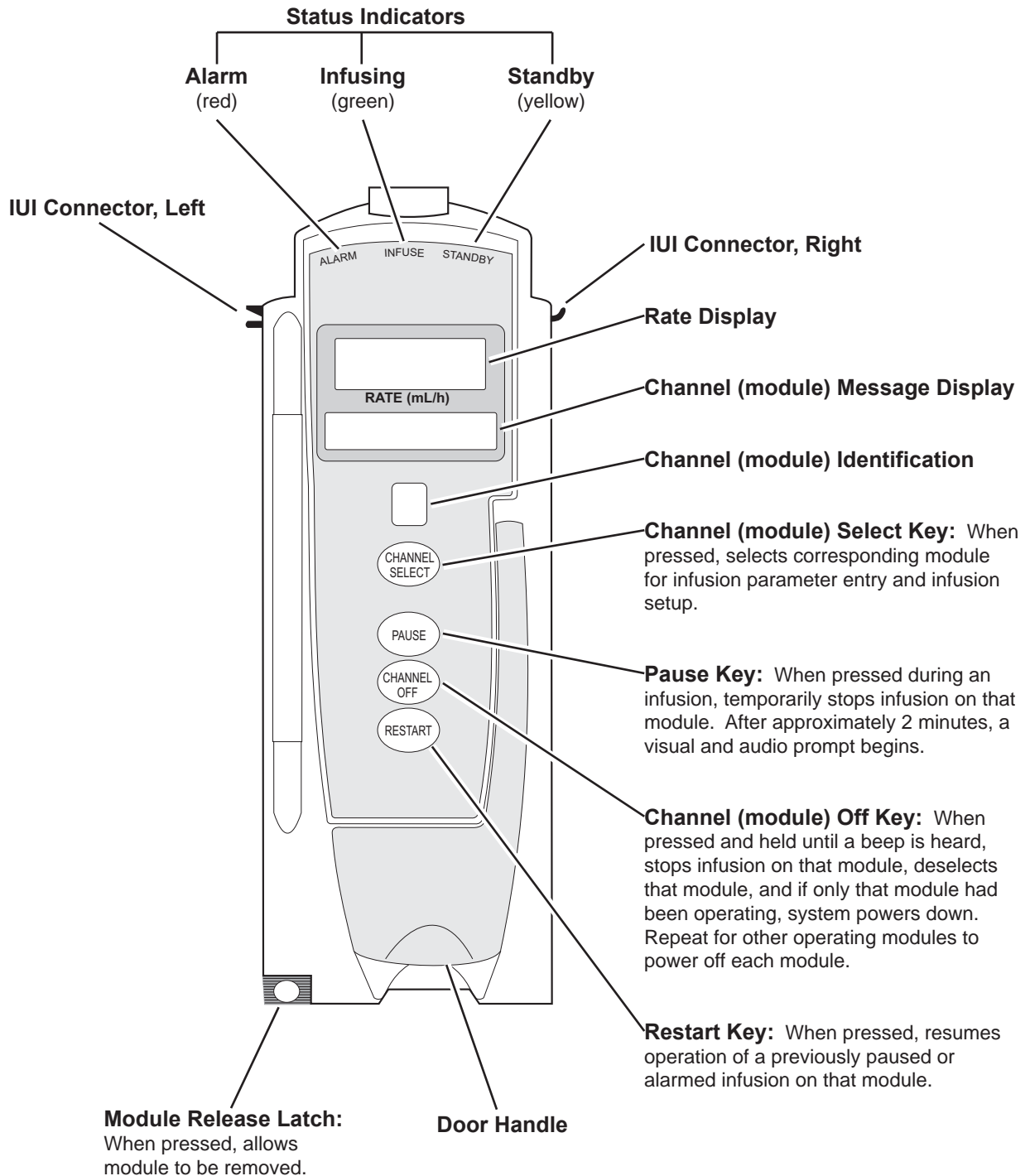

Features and Displays (Continued)

Operating Features, Controls, Indicators (Continued)

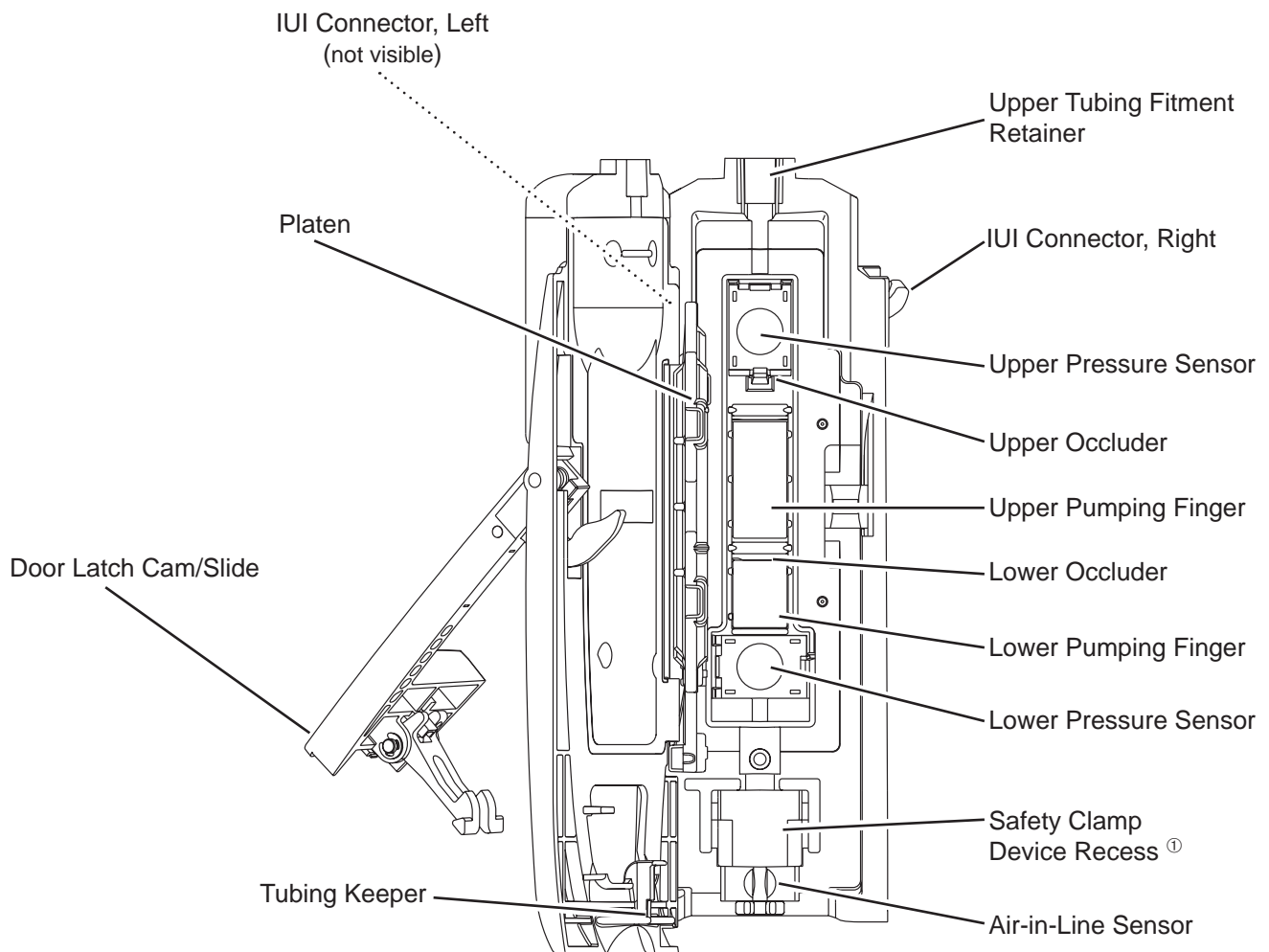

NOTE:

① "Safety clamp" is referred to on the device as "Flo-Stop".

Features and Displays (Continued)

Operating Features, Controls, Indicators (Continued)

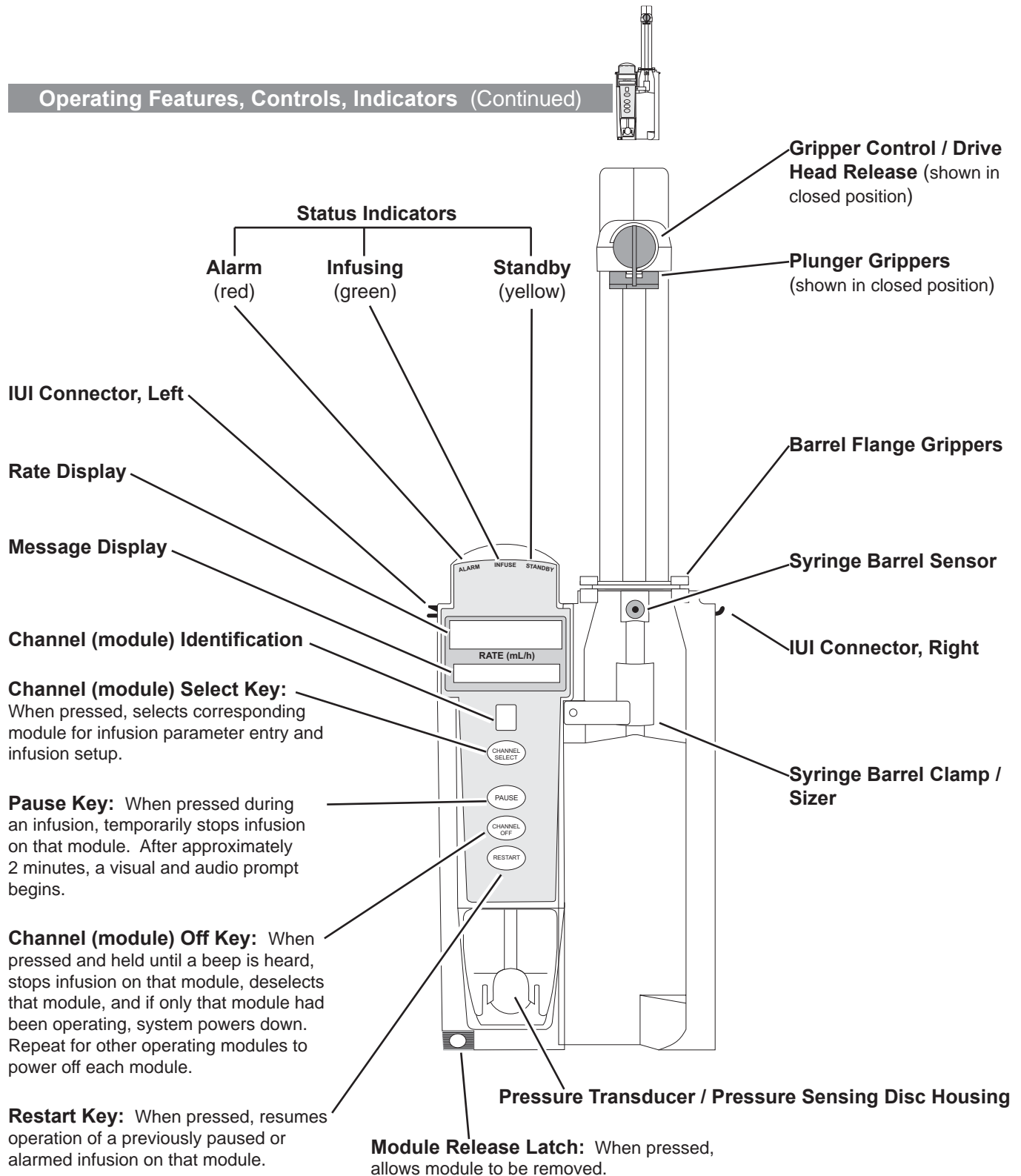

Features and Displays (Continued)

Displays

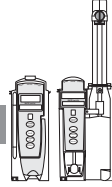

The displays illustrated throughout this document are for illustration purposes only. The display content varies, depending on configuration settings, type of administration set in use, hospital-defined Data Set uploaded using the Guardrails® Suite MX, programmed drug calculation parameters, and many other variables. Reference specific drug product labeling for information concerning appropriate administration techniques and dosages.

Main Display

See the PC Unit Section of this DFU.

Dynamic Pressure Display

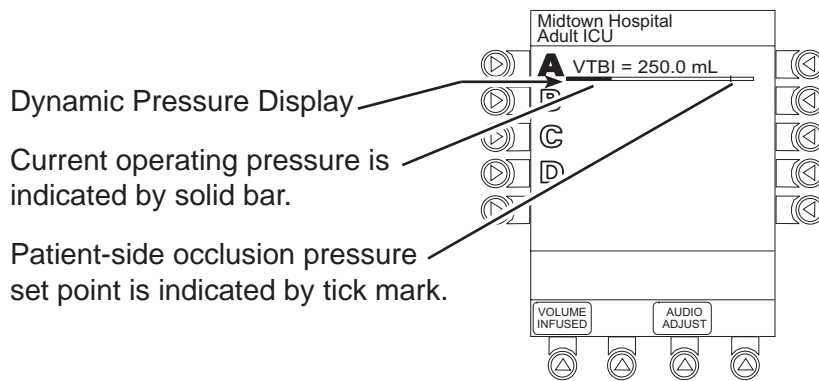

CAUTION

Although the dynamic pressure display bars for the Syringe Module and Pump Module both use the full width of the screen for display, they each **represent different ranges**. The Pump Module's range is 50 to 525 mmHg and the Syringe Module's range is 25 to 1000 mmHg.

Drug Calculation Definitions and Formulas

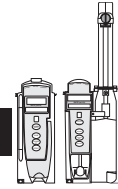

The Pump and Syringe Modules use the following parameters, entered during the drug calculation setup procedure:

- **Bolus dose duration:** Time period over which bolus dose is to be administered.
- **Bolus dose units:** Units used in calculating bolus dose. Bolus dose units are selected from alternatives provided.
- **Diluent volume:** Volume of fluid used as diluent for drug (mL).
- **Dosing units:** Units used to calculate continuous infusion drug dose. Dosing Units are selected from alternatives provided.
- **Drug amount:** Amount of drug in IV container (gram, mg, mcg, mEq, or units).
- **Patient weight:** Weight of patient (kg); this is an optional parameter that is not needed unless drug dose is normalized for patient weight.
- **Time units:** Time base for all calculations (minute, hour, or day).

The bolus dose, drug dose, and flow rate parameters are calculated using the above parameters, as follows:

- Bolus dose = bolus dose x patient weight (if used).
- Bolus dose administration rate (**INFUSE AT**):
When duration is entered = total dose / duration in minutes.
When Max Rate is used = Max Rate / 60 x concentration.
- Bolus dose duration = bolus VTBI / bolus rate.
- Bolus dose VTBI = bolus dose / drug concentration.
- Bolus rate = bolus VTBI / duration.
- Continuous drug dose = flow rate x drug concentration (normalized for patient weight if specified by entering a patient weight).
- Continuous flow rate = drug dose / drug concentration (normalized for patient weight if specified by entering a patient weight).
- Duration = VTBI / rate.
- Drug concentration = drug amount / diluent volume.
- Rate = VTBI / duration.

WARNING

The Drug Calculation feature is to be used only by **personnel properly trained** in the administration of continuously infused medications. Extreme caution should be exercised to ensure the correct entry of the drug calculation infusion parameters.

Drug Calculation Definitions and Formulas (Continued)

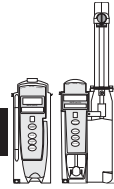

- Total bolus dose:
 Bolus dose not weight-based = bolus dose entered.
 Bolus dose weight-based = bolus dose x patient weight.
- Total dose:
 Drug amount.
 Drug amount / patient body surface area (BSA).
 Drug amount / patient weight.

Configurable Settings

See the PC Unit Section of this DFU for system configurable settings.

If the configuration settings need to be changed from the **Factory default** settings, reference the applicable Technical Service Manual or contact Cardinal Health Technical Support, for technical, troubleshooting, and preventive maintenance information.

With the Profiles feature enabled, the settings are configured independently for each profile. A hospital-defined, best-practice Data Set must be uploaded to enable the Profiles feature. Date and Time is a system setting and is the same in all profiles.

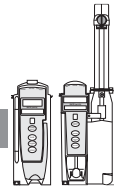

Shared Infusion

Feature	Default Setting	Options
Delay Options	Disabled	Enabled - Disabled
• Callback	None	None, Before, After, Before and After
Drug Calculation	Disabled	Enabled - Disabled
• Bolus Dose	Disabled	Enabled - Disabled
Multidose	Disabled	Enabled - Disabled
• Callback	None	None, Before, After, Before and After
Pressure Dynamic (Dynamic Pressure Display)	Disabled	Enabled - Disabled
Volume/Duration	Disabled	Enabled - Disabled

Configurable Settings (Continued)

Pump Module



Feature	Default Setting	Options
Accumulated Air	Enabled	Enabled - Disabled
Air-in-Line Settings (single bolus)	75 mL	50, 75 or 250 mL Anesthesia Mode only: 500 mL
Auto-Restart Attempts	0	0 - 9 attempts Anesthesia Mode only: 9 attempts
KVO Rate Adjust (Keep Vein Open)	1 mL/h	0.1 - 20 mL/h
Max Rate	999 mL/h	0.1 - 99.9 mL/h in 0.1 mL/h increments; 100 - 999 mL/h in 1.0 mL/h increments.
Max VTBI	9999 mL	0.1 - 9999 mL
Pressure Mode		
• Mode Selection	Pump	Pump, Selectable
• Lock Status	Unlocked	Locked, Unlocked
• Max Occlusion Pressure	525 mmHg	50 - 525 mmHg in 25 mmHg increments (adjustable only in Selectable Pressure Mode)
• Default Starting Occlusion Pressure	525 mmHg	50 - 525 mmHg in 25 mmHg increments (configured by profile and adjustable only in Selectable Pressure Mode)
SEC to PRI Alert	Enabled	Enabled - Disabled
Secondary (Dual Rate Sequential Piggybacking)	Disabled	Enabled - Disabled

Configurable Settings (Continued)

Syringe Module



Feature	Default Setting	Options
ALL Mode	Disabled	Enabled - Disabled
Auto Pressure	Disabled	Enabled - Disabled
Back Off (after occlusion)	Enabled	Enabled - Disabled
Fast Start	Enabled	Enabled - Disabled
KVO (Keep Vein Open)	Disabled	Enabled - Disabled
• Rate Adjust	1 mL/h	0.01 - 2.5 mL/h (0.01 - 0.09 mL/h available for 1 mL and 3 mL syringes)
• Volume Adjust	5%	0.5 - 5%
Max Rate	999 mL/h	0.1 - 99.9 mL/h in 0.1 mL/h increments; 100 - 999 mL/h in 1 mL/h increments
Near End (NEOI)	Disabled	Enabled - Disabled
• Alert Time	60	1 - 60 minutes or 25% of remaining infusion time, whichever comes later
Occlusion Pressure Set Point:		
• With Disc	1000 mmHg	25 - 1000 mmHg in 1 mmHg increments
• No Disc	High	Low, Medium, High
Priming	Disabled	Enabled - Disabled

Specifications

Pump Module



Accumulated Air Window:	<u>Single Bolus Setting</u>	<u>Volume Window (mL)</u>	<u>% Air that Causes Alarm</u>
		50	2.8
	75	8.0	20%
	250	8.0	30%
	*500	12.0	30%

* In Anesthesia Mode only.

Bolus Volume, Maximum after Occlusion:	<u>Pressure Limit (mmHg)</u>	<u>Rate (mL/h)</u>	<u>Bolus Volume (mL)</u>
		50	25
	525	25	≤0.6

Critical Volume: The maximum over-infusion which can occur in the event of a single fault condition is 0.6 mL.

Dimensions: 3.3" W x 8.9" H x 5.5" D

Environmental Conditions:	<u>Operating</u>	<u>Storage/Transport</u>
	Atmospheric Pressure:	525 - 4560 mmHg (700 - 6080 hPa)
Relative Humidity: (Avoid prolonged exposure to relative humidity >85%)	20 - 90% Noncondensing	5 - 85% Noncondensing
Temperature Range:	41 - 104° F (5 - 40° C)	-4 - 140° F (-20 - 60° C)

Equipment Orientation: To ensure proper operation, Alaris® System must remain in an upright position.

Flow Rate Programming Increments:

Rate Range (mL/h)	Increments (mL/h)	
	User Input Rates	Device Calculated Rates
0.1 - 9.99	0.1	0.01
10 - 99.9		0.1
100 - 999	1	1

Fluid Ingress Protection: IPX1, Drip Proof

Specifications (Continued)

Pump Module (Continued)



Infusion of Air, Means to Protect Patient from:

Ultrasonic Air-in-Line Detection
Maximum single bolus size = selectable 50, 75 or 250 microliters nominal (500 microliters in Anesthesia Mode)

Infusion Pressure, Maximum:

654 mmHg (Maximum Occlusion Alarm Threshold plus tolerance)

KVO (Keep Vein Open) Rate:

Factory Default Setting is 1 mL/h if set rate is 1 mL/h or above; or set rate, if rate is 0.9 mL/h or below.

KVO Selection Range:

KVO rate can be set in System Configuration from 0.1 - 20 mL/h in 0.1 mL/h increments.

Occlusion Alarm Thresholds:

Pump Mode: 525 mmHg at rates ≥ 30 mL/h
Varying level based on rate and patient back-pressure at rates < 30 mL/h.

Selectable Mode: User selected, 50 - 525 mmHg in 25 mmHg increments.

Operating Principle:

Positive displacement

Rate Accuracy:

Rate accuracy of Alaris® System is $\pm 5\%$ at rates between 1 and 999 mL/h and $\pm 5.5\%$ at rates < 1 mL/h, 95% of the time with 95% confidence, under conditions listed below.

Infusion Rate Range: 0.1 - 999 mL/h
Ambient Temperature: $68 \pm 4^\circ$ F ($20 \pm 2^\circ$ C)
Source Container Height: 20 inches above top of Pump Module
Test Solution: Distilled Water
Distal Back pressure: 0 mmHg (0 kPa)
Needle: 18 gauge
Administration Set Model: 2210

WARNING

Variations of head height, back pressure or any combination of these **may affect rate accuracy**. Factors that can influence head height and back pressure are: Administration set configuration, IV solution viscosity and IV solution temperature. Back pressure may also be affected by type of catheter. See "Trumpet and Start-Up Curves" for data on how these factors influence rate accuracy.

Specifications (Continued)

Pump Module (Continued)



Shock Protection: Type CF, Defibrillator Proof

Time to Alarm, Maximum:	<u>Pressure Limit (mmHg)</u>	<u>Rate (mL/h)</u>	<u>Time to Alarm</u>
	50	1	≤5 minutes
	50	25	≤15 seconds
	525	1	≤45 minutes
	525	25	≤2 minutes

Volume to be Infused Programming Increments:	<u>Range (mL)</u>	<u>Increments (mL)</u>
	0.1 - 9.99	0.01
	10 - 999.9	0.1
	1000 - 9999	1

Weight: 2.5 lbs

Syringe Module



Bolus Volume, Maximum after Occlusion:	<u>Pressure Setting</u>	<u>Bolus Volume (mL)</u>	
Without Pressure Sensing Disc:	Low	0.512	
	Medium	0.776	
	High	1.103	
With Pressure Sensing Disc:		<u>Bolus Volume (mL)</u>	
		<u>Back Off Disabled</u>	<u>Back Off Enabled</u>
	300 mmHg	0.462	0.126
	500 mmHg	0.575	0.331
	1000 mmHg	0.839	0.323

Alaris® System has a back-off safety feature which, when enabled and a pressure sensing disc is in use, is designed to reduce bolus volume on occlusion release.

-- Continued on Next Page --

Specifications (Continued)

Syringe Module (Continued)



Bolus Volume, Maximum after Occlusion: (Continued)

Maximum Bolus Volume specifications are based on following standard operating conditions:

Atmospheric Pressure:	645 - 795 mmHg
Disposable Type:	
No Pressure Disc:	#30914
With Pressure Disc:	#30920
Humidity:	20 - 90%
Rate:	5 mL/h
Syringe Type:	BD 50/60 mL
Temperature:	68 ±4° F
Volume Collection Time:	approximately 2 minutes

WARNING

Installing a pressure sensing disc after an infusion has started can result in a bolus to the patient.

Critical Volume:

Maximum over-infusion which can occur in the event of a single-fault condition will not exceed 2% of nominal syringe fill volume during loading and 1% of maximum syringe travel after syringe loading.

Dimensions:

4.5" W x 15.0" H x 7.5" D

Environmental Conditions:

	<u>Operating</u>	<u>Storage/Transport</u>
Temperature Range:	41 - 104° F (5 - 40° C)	-4 - 140° F (-20 - 60° C)
Relative Humidity: (Avoid prolonged exposure to relative humidity >85%)	20 - 90% Noncondensing	5 - 85% Noncondensing
Atmospheric Pressure:	525 - 4560 mmHg (700 - 6080 hPa)	375 - 760 mmHg (500 - 1013 hPa)

Equipment Orientation:

To ensure proper operation, Alaris® System must remain in an upright position.

Specifications (Continued)

Syringe Module (Continued)



Flow Rate Programming: Flow rate range is from 0.01 to 999 mL/h and can be selected as follows:

<u>Flow Rates (mL)</u>	<u>Selectable Increments (mL/h)</u>
0.01 - 9.99	0.01
10 - 99.9	0.1
100 - 999	1

<u>Rate Restriction by Syringe Size:</u>	<u>Syringe Size (mL)</u>	<u>Flow Rate Range (mL/h)</u>
	50/60	0.1 - 999
	30	0.1 - 650
	20	0.1 - 500
	10	0.1 - 250
	5	0.1 - 150
	3	0.01 - 100
	1	0.01 - 30

Fluid Ingress Protection: IPX1, Drip Proof

**Infusion Pressure,
Maximum:**

Without Pressure Sensing Disc: approximately 800 mmHg (actual occlusion pressure varies based on syringe size and manufacturer)

With Pressure Sensing Disc: 1060 mmHg

KVO (Keep Vein Open) Rate: Factory default setting is 1 mL/h if set rate is 1 mL/h or above; or set rate, if rate is 0.9 mL/h or below.

KVO Selection Range: KVO rate can be set in System Configuration, in 0.01 mL/h increments, as follows:

0.01 - 2.5 mL/h (0.01 - 0.09 mL/h available for 1 mL and 3 mL syringes)

Occlusion Alarm Thresholds:

Without Pressure Sensing Disc: Three settings: Low, Medium, High

With Pressure Sensing Disc: User selected, 25 - 1000 mmHg in 1 mmHg increments.

Operating Principle: Positive displacement

Specifications (Continued)



Syringe Module (Continued)

Rate Accuracy: $\pm 2\%$ of full scale plunger travel (not including syringe variation)

WARNING

Syringe size and running force, variations of back pressure, or any combination of these **may affect rate accuracy**. Factors that can influence back pressure are: Administration set configuration, IV solution viscosity, and IV solution temperature. Back pressure may also be affected by type of catheter. See "Trumpet and Start-Up Curves" for data on how these factors influence rate accuracy.

Shock Protection: Type CF, Defibrillator Proof

Time to Alarm, Maximum:

Rate (mL/h)	Pressure Limit	
	No Disc High Setting	With Disc Highest (1000 mmHg) Setting
1	120 minutes	105 minutes
5	30 minutes	30 minutes

Maximum Time to Alarm specifications are based on following standard operating conditions:

Atmospheric Pressure: 645 - 795 mmHg
 Back Pressure: 0 mmHg before producing occlusion
 Disposable Type:
 No Pressure Disc: #30914
 With Pressure Disc: #30920
 Humidity: 20 - 90%
 Syringe Type: BD 50/60 mL
 Temperature: 68 \pm 4° F

Volume to be Infused Programming Increments:	<u>Range (mL)</u>	<u>Increments (mL)</u>
	0.1 - 9.99	0.01
	10 - 60	0.1

Weight: 4.5 lbs

Symbols

See the PC Unit Section of this DFU for system symbols.

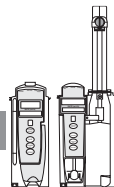

Pump and Syringe Modules



Type CF defibrillation-proof equipment.

Single-Use



Single-Use. Do not reuse.



Product contains micron filter, where XX represents filter size.



DEHP in fluid pathway.



No DEHP in fluid pathway.



Product is latex-free.



Product incorporates Needle-Free Valve ports and should not be accessed by a needle.



Approximate administration set priming volume.



Expiration date for product is identified near hour glass symbol.



Do not use if package is damaged.



Manufacturer



Authorized representative in European Community.

Pump Module



Drops per milliliter specification for product is identified on drop symbol.

Trumpet and Start-Up Curves

Introduction

Pump and Syringe Modules

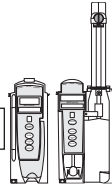

In this instrument, as with all infusion systems, the action of the pumping mechanism and variations in individual administration sets cause short-term fluctuations in rate accuracy. The following graphs show typical performance of the system, as follows:

- Accuracy during various time periods over which fluid delivery is measured (trumpet curves).
- Delay in onset of fluid flow when infusion commences (start-up curves).

Trumpet curves are named for their characteristic shape. They display discrete accuracy data averaged over particular time periods or "observation windows", not continuous data versus operating time.

Over long observation windows, short-term fluctuations have little effect on accuracy, as represented by the flat part of the curve. As the observation window is reduced, short-term fluctuations have greater effect, as represented by the "mouth" of the trumpet. Knowledge of system accuracy over various observation windows may be of interest when certain drugs are being administered.

Because the clinical impact of short-term fluctuations on rate accuracy depends on the half-life of the drug being infused and on the degree of intravascular integration, the clinical effect cannot be determined from the trumpet curves alone. Knowledge of the start-up characteristics should also be considered.

The start-up curves represent continuous flow rate versus operating time for 2 hours from the start of the infusion. They exhibit the delay in onset of delivery due to mechanical compliance and provide a visual representation of uniformity. Trumpet curves are derived from the second hour of this data.

Trumpet and Start-Up Curves (Continued)

Introduction (Continued)

Pump Module

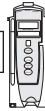

Effects of Pressure Variations

Under conditions of +100 mmHg pressure, the Pump Module typically exhibits a long-term accuracy offset of approximately -0.7% from mean values.

Under conditions of +300 mmHg pressure, the Pump Module typically exhibits a long-term accuracy offset of approximately -4.2% from mean values.

Under conditions of -100 mmHg pressure, the Pump Module typically exhibits a long-term accuracy offset of approximately +4.4% from mean values.

Resulting trumpet observation points typically track those of accuracy; therefore, no significant change in short-term variations result under these pressure conditions.

Effects of Negative Solution Container Heights

With a negative head height of -0.5 meters, the Pump Module typically exhibits a long-term accuracy offset of approximately -3.1% from mean values.

Resulting trumpet observation points typically track those of accuracy; therefore, no significant change in short-term variations result under negative head height conditions.

Syringe Module



Trumpet and start-up curves have been provided for 1.0 mL/h and 5.0 mL/h. Measurements for trumpet curve rates below 1.0 mL/h are not provided because of the difficulty in measuring extremely small volumes over a large duration of time. In this case, the linear relationship of the plunger position and velocity to syringe volume and rate is verified, and is a function of the accuracy of the design.

Trumpet and Start-Up Curves (Continued)

Introduction (Continued)

Syringe Module (Continued)



Measurements for trumpet curve rates above 5.0 mL/h are also not provided, as the syringe volume is displaced in a very short time with a rate up to 999 mL/h. Accuracy, however, is assured with the design implementation.

Under conditions of -100 mmHg, +100 mmHg, and +300 mmHg pressures, the Syringe Module typically exhibits a long-term accuracy offset of approximately 0.2% or less from the mean value.

Trumpet and Start-Up Curves (Continued)

Graphs

Pump Module

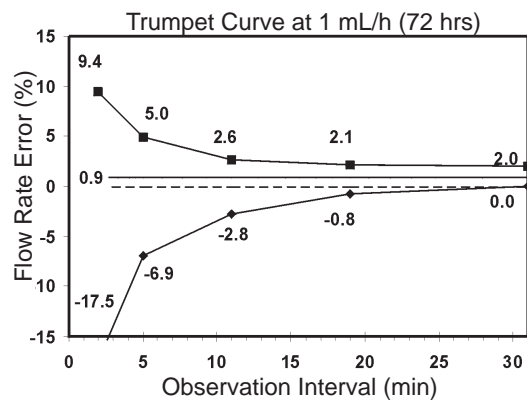
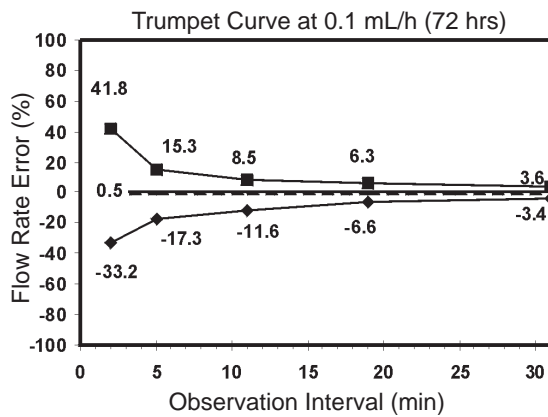
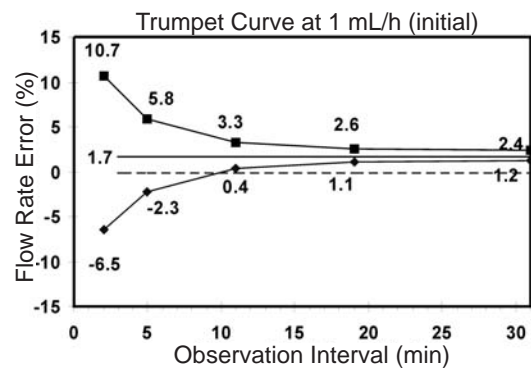
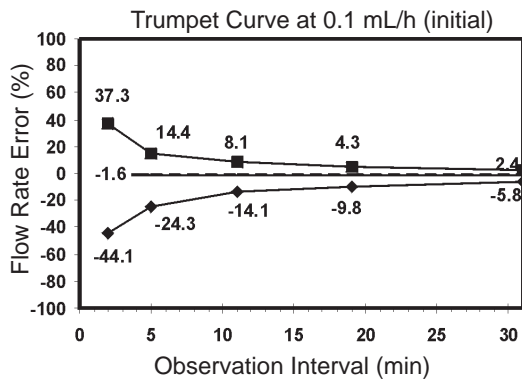
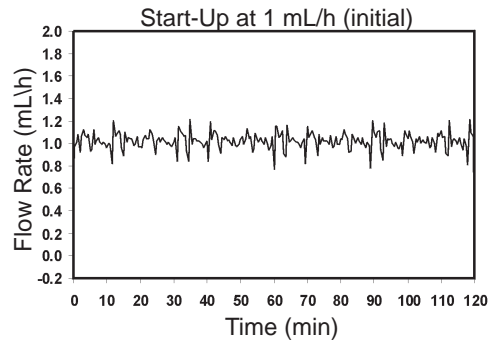
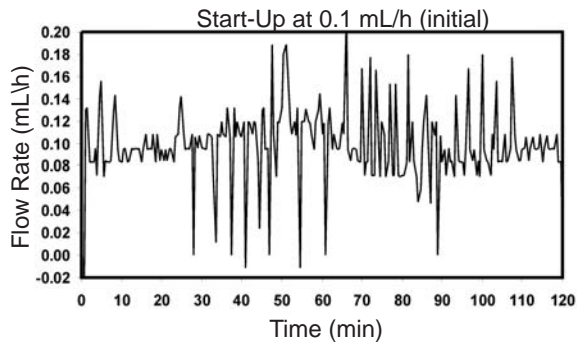
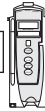

NOTE: The plot range has been increased to $\pm 100\%$, to allow visualization of the graph.

Legend:

- Maximum rate error
- Overall rate error
- ◆ Minimum rate error

Trumpet and Start-Up Curves (Continued)

Graphs (Continued)

Pump Module (Continued)

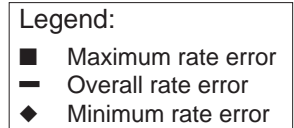
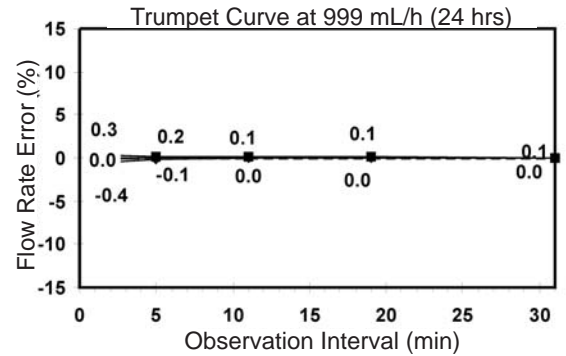
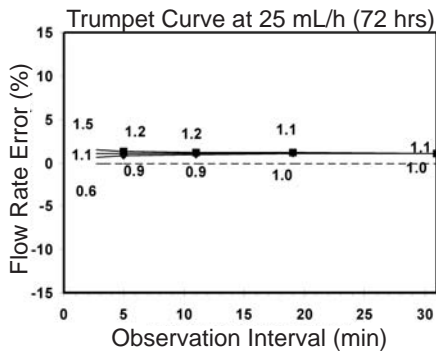
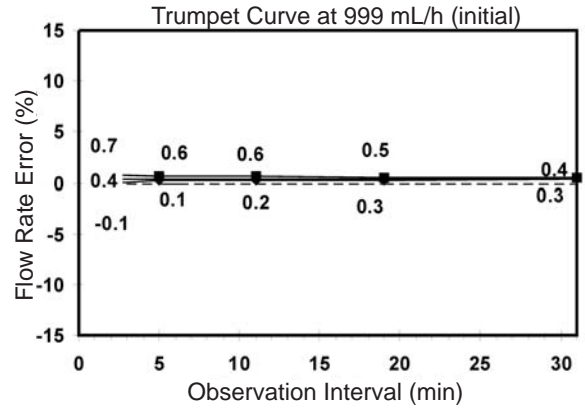
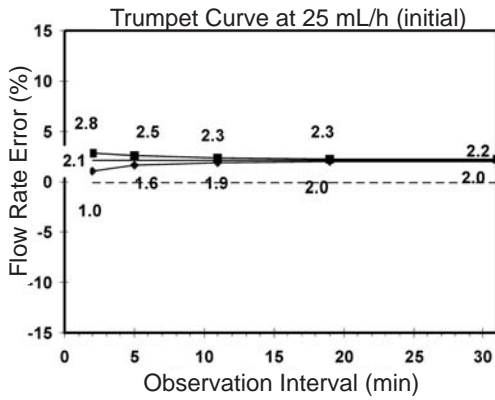
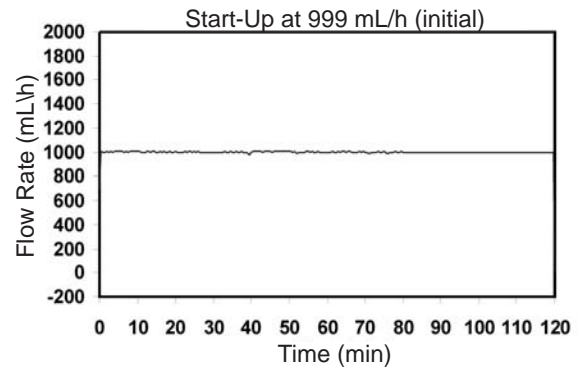
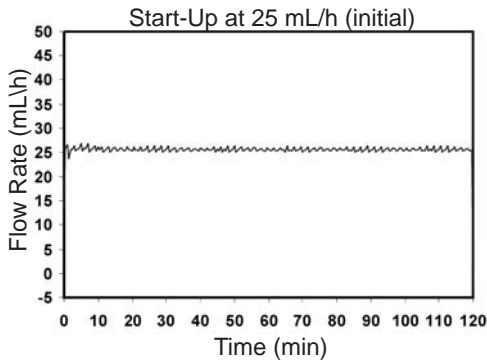
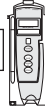

Trumpet and Start-Up Curves (Continued)

Graphs (Continued)

Syringe Module



Start-Up Curve at 1 mL/h (initial) 1 g/mL

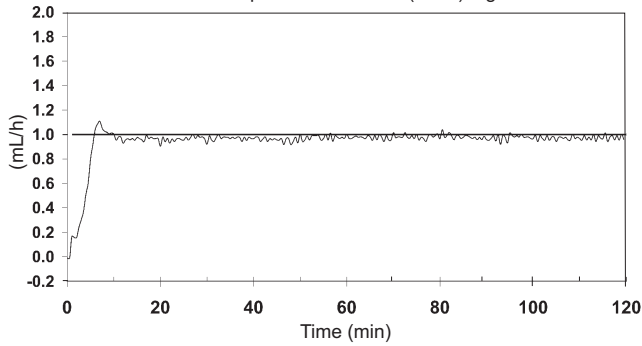

Start-Up Curve at 5 mL/h (initial) 1 g/mL

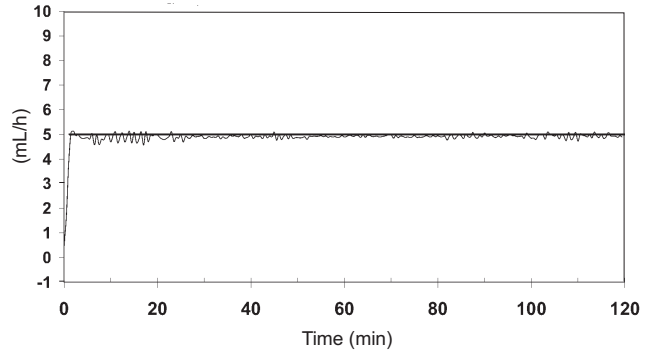

Trumpet Curve at 1 mL/h (initial)

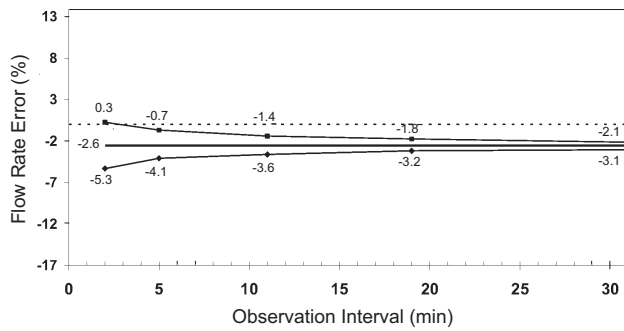

Trumpet Curve at 5 mL/h (initial)

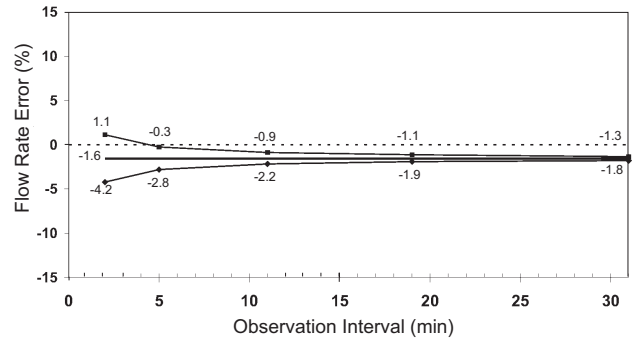

Legend:

- Maximum rate error
- Overall rate error
- ◆ Minimum rate error

THIS PAGE
INTENTIONALLY
LEFT BLANK

Troubleshooting and Maintenance

General

The Pump Module and Syringe Module Technical Service Manuals are available from Cardinal Health. They include routine service schedules, interconnect diagrams, component parts lists and descriptions, test procedures, and other technical information, to assist qualified service personnel in repair and maintenance of the instrument's repairable components. Maintenance procedures are intended to be performed only by qualified personnel, using the Service Manuals and System Maintenance software.

Artifacts: It is normal for an infusion device to produce nonhazardous currents when infusing electrolytes. These currents vary proportional to the infusion device flow rate. When an ECG monitoring system is not functioning under optimal conditions, these currents may appear as artifacts, simulating actual ECG readings. To determine if ECG abnormalities are caused by patient condition or the ECG equipment, place the infusion device on hold. If the ECG readings become normal, the ECG equipment requires attention. Proper setup of the ECG equipment should eliminate these artifacts. Reference the appropriate ECG monitoring system documentation for instructions on setup and maintenance.

Alarms, Errors, Messages

See the PC Unit Section of this DFU for the following system references:

- Alarms, Errors, Messages
- Audio Characteristics
- Definitions
- Radio Frequency Note

Alarms, Errors, Messages (Continued)

Definitions

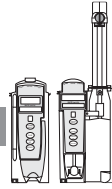

Alert

A visual message to help reduce programming errors by indicating a Limit (Soft or Hard) has been exceeded. A response is required before programming can continue.

Clinical Advisory

A visual message when a designated drug is selected, to remind clinician of specific hospital/facility standards of practice when programming an IV medication. A specific Clinical Advisory and/or message can be associated with a selected drug within any of the patient care profiles. Clinical Advisories are not displayed in Anesthesia mode.

Audio Characteristics



Type	Sound	Notes
Switchover	Six short beeps: secondary switching to primary. Two short beeps: bolus switching to continuous.	Variable volume; can be silenced and disabled in System Configuration.

Alarms

Pump and Syringe Modules

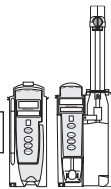

Alarm	Meaning	Response
Channel Disconnected	Module(s) disconnected while in operation or have a communication problem.	To silence alarm and clear message from screen, press CONFIRM soft key. Reattach module if desired, ensuring it is securely "clicked" into place at Module Release Latch. If alarm is still present, replace module with an operational instrument.

Alarms, Errors, Messages (Continued)

Alarms (Continued)

Pump Module



Alarm	Meaning	Response
Accumulated Air-in-Line	A large number of air bubbles smaller than current air-in-line limit has recently passed detector.	Clear air from line. To continue infusion, press RESET soft key and then RESTART key.
Air-in-Line	Air has been detected in administration set during an infusion. Infusion stops on affected module.	Ensure tubing is properly installed in Air-in-Line Detector. If air is present, clear air from administration set. Press RESTART key, or press CHANNEL SELECT key and then START soft key.
Check IV Set	Administration set is not properly installed. Infusion stops on affected module.	Close roller clamp, remove and reinstall administration set, close door, open roller clamp, and then press RESTART key.
Close Door	Door opened during an infusion. Infusion stops on affected module.	Close door. Press RESTART key, or press CHANNEL SELECT key and then START soft key.
Flo-Stop Open - Close Door	Safety clamp device is in open position while door is open.	Close roller clamp on administration set or close door.
Occluded - Fluid Side/Empty Container	Indicates either upstream occlusion or empty container. Infusion stops on affected module.	Clear occlusion on fluid side of instrument. If necessary, refill drip chamber. Press RESTART key, or press CHANNEL SELECT key and then START soft key.
Occluded - Patient Side	Increased back pressure sensed while infusing in pump delivery mode. Infusion stops on affected module.	Clear occlusion. Press RESTART key, or press CHANNEL SELECT key and then START soft key.
Partial Occlusion - Patient Side	Partial occlusion of patient side of IV line detected by Auto-Restart feature.	Clear occlusion. Press RESTART key, or press CHANNEL SELECT key and then START soft key.

Alarms, Errors, Messages (Continued)

Alarms (Continued)

Pump Module (Continued)



Alarm	Meaning	Response
Pump Chamber Blocked	Blocked pump chamber detected.	Open door and inspect pump chamber. To open blockage, as required, massage tubing. To continue infusion, press RESET soft key and then RESTART key.
Restart Channel	Door opened and closed during an infusion. Infusion stops on affected module.	Close door. Press RESTART key, or press CHANNEL SELECT key and then START soft key.
	Module paused for 2 minutes.	Press RESTART key, or press CHANNEL SELECT key and then START soft key.

Syringe Module



Alarm	Meaning	Response
Occlusion	Increased back pressure sensed while infusing. Infusion stops on affected module.	Clear occlusion. Press RESTART key, or press CHANNEL SELECT key and then START soft key.
Pressure Disc Installed	Pressure sensing disc installed during an infusion. Infusion stops on affected module.	Press CONFIRM soft key and RESTART key.
Pressure Disc Removed	Pressure sensing disc removed. Infusion stops on affected module.	Reinsert pressure sensing disc and press RESTART key.

Alarms, Errors, Messages (Continued)

Alarms (Continued)

Syringe Module (Continued)



Alarm	Meaning	Response
Syringe Empty	<p>Syringe is empty.</p> <p>If syringe is not empty, other possibilities are:</p> <ul style="list-style-type: none"> • Pressure sensing disc inappropriate/defective. • Syringe plunger travel impeded. • Pressure transducer defective. 	<ul style="list-style-type: none"> ➤ Set up new infusion or press CHANNEL OFF key. ➤ Verify appropriate pressure sensing disc is in use and functioning properly. ➤ Verify syringe plunger movement is unimpeded. ➤ If syringe is not empty and above actions do not correct alarm, replace module with an operational instrument.

Syringe Adjustment Alarms



When a syringe installation problem is detected, a visual signal is displayed. Text in the display blinks to indicate the location of the problem.

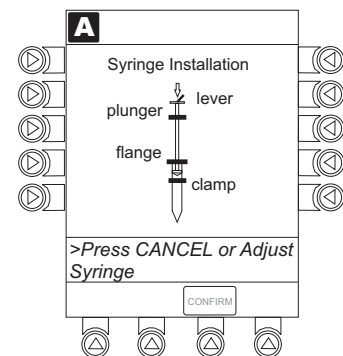

-- Continued on Next Page --

Alarms, Errors, Messages (Continued)

Alarms (Continued)

Syringe Adjustment Alarms (Continued)



- When problem is corrected, press **CONFIRM** soft key.

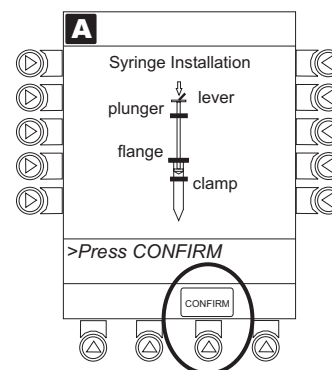

Alarm	Meaning	Response
Check Syringe	Plunger grippers opened during infusion and then closed. Infusion stops on affected module. ➤	Securely lock plunger grippers, press CHANNEL SELECT key, and reselect syringe.
	Syringe barrel clamp opened during infusion and then closed. Infusion stops on affected module. ➤	Securely lock syringe barrel clamp and press RESTART key.
	Syringe plunger not captured while in idle state. System alarms after 30 seconds, to indicate potential siphoning condition. ➤	Check for potential siphoning. Ensure administration set clamp (roller/slide) is in closed position. Securely lock plunger grippers over syringe plunger.
Drive Not Engaged	Drive system disengaged during operation.	Open and close plunger grippers and syringe barrel clamp. Ensure syringe is properly installed.

Alarms, Errors, Messages (Continued)

Errors

Pump and Syringe Modules

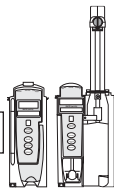

Error

Meaning

Response

Channel Error

Error detected. Operation stops on affected module.

To silence alarm and continue operation of unaffected module(s), press **CONFIRM** soft key. Replace module with an operational instrument, as needed.

Syringe Module



Error

Meaning

Response

Syringe Calibration Required

Error on infusing module indicating calibration is required. Infusion stops on affected module. **CALIBRATE** scrolls in Message Display.

To silence alarm and continue operation of unaffected module(s), press **CONFIRM** soft key. Replace module with an operational instrument, as needed.

Syringe Driver Head Error

Noninfusing module, with plunger grippers open, senses excessive pressure being applied downward on Drive Head. **OCCLUSION** scrolls in Message Display.

To silence alarm and continue normal operation, press **CONFIRM** soft key.

Alarms, Errors, Messages (Continued)

Messages

Pump and Syringe Modules

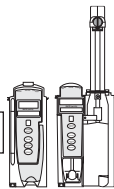

Message	Meaning	Response
Anesthesia Mode	Anesthesia Mode discontinued when disconnected from AC.	Press CONFIRM soft key.
Bolus Dose Complete	Module running in continuous infusion mode if programmed.	None
Delay Complete	Delay time completed.	Press RESTART key, or press CHANNEL SELECT key and then START soft key.
Infusion Complete	Current infusion completed.	Set up a new infusion or press CHANNEL OFF key.
Infusion Complete - KVO	Programmed volume-to-be-infused delivered; module running at KVO rate.	Set up a new infusion or press CHANNEL OFF key.
Panel Locked	Tamper Resist feature is active and a key was pressed.	If appropriate, deactivate Tamper Resist feature using Tamper Resist Control on back of PC Unit.
Panel Unlocked	Tamper Resist feature deactivated.	None.
Pause	Pause control pressed; infusion stopped.	To resume infusion, press RESTART key, or press CHANNEL SELECT key and then START soft key.
Start time for next dose has passed.	Start of next dose passed.	Press CONFIRM soft key.

Alarms, Errors, Messages (Continued)

Messages (Continued)

Pump Module



Message	Meaning	Response
Checking Line	Patient-side occlusion occurred; Auto-Restart feature monitoring downstream pressure to determine if infusion can continue.	None
Secondary	Secondary infusion in progress on indicated module.	None. When secondary VTBI="0", infusion reverts to programmed primary parameters.

Syringe Module

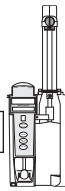

Message	Meaning	Response
After Call Back	Infusion completed.	Press CONFIRM soft key.
NEOI (Near End of Infusion)	Syringe almost empty.	None. This is a timed event that can be set. To set or change this option, see "General Information", "Configurable Settings".
Syringe Not Recognized	Installed syringe of unknown type and size.	Select and confirm correct syringe type and size, and then press CONFIRM ; or use a syringe type and size that system can automatically and correctly identify.

Alarms, Errors, Messages (Continued)

Possible End of Infusion Messages and Alerts (Syringe Module)



KVO	VTBI	Delayed	PC Unit Display	Module Display	Audio / Visual Alert
N/A	All	Yes	Syringe Empty	Syringe Empty	Yes / Yes
On	All	No	Syringe Empty	Syringe Empty	Yes / Yes
Off	All	No	Syringe Empty	Syringe Empty	Yes / Yes
N/A	Numeric	Yes	Complete	Infusion Complete	Yes / Yes (if an After callback is scheduled)
N/A	Numeric	Yes	Syringe Empty	Syringe Empty	Yes / Yes
Off	Numeric	No	Complete	Infusion Complete	Yes / Yes
Off	Numeric	No	Syringe Empty	Syringe Empty	Yes / Yes
On	Numeric	No	Syringe Empty	Syringe Empty	Yes / Yes

Inspection Requirements

To ensure the Alaris® System remains in good operating condition, both regular and preventive maintenance inspections are required. Reference the System Maintenance software for detailed instructions.

REGULAR INSPECTIONS

PROCEDURE	FREQUENCY
INSPECT FOR DAMAGE:	
Exterior Surfaces	Each usage
Keypad	Each usage
Seal	Each usage
Mechanical Parts	Each usage
CLEANING	As required
START-UP	Each usage

WARNING

Failure to perform these inspections may result in improper instrument operation.

CAUTION

Regular and preventive maintenance inspections should only be performed by qualified service personnel.

Alaris® PCA Module
Model 8120

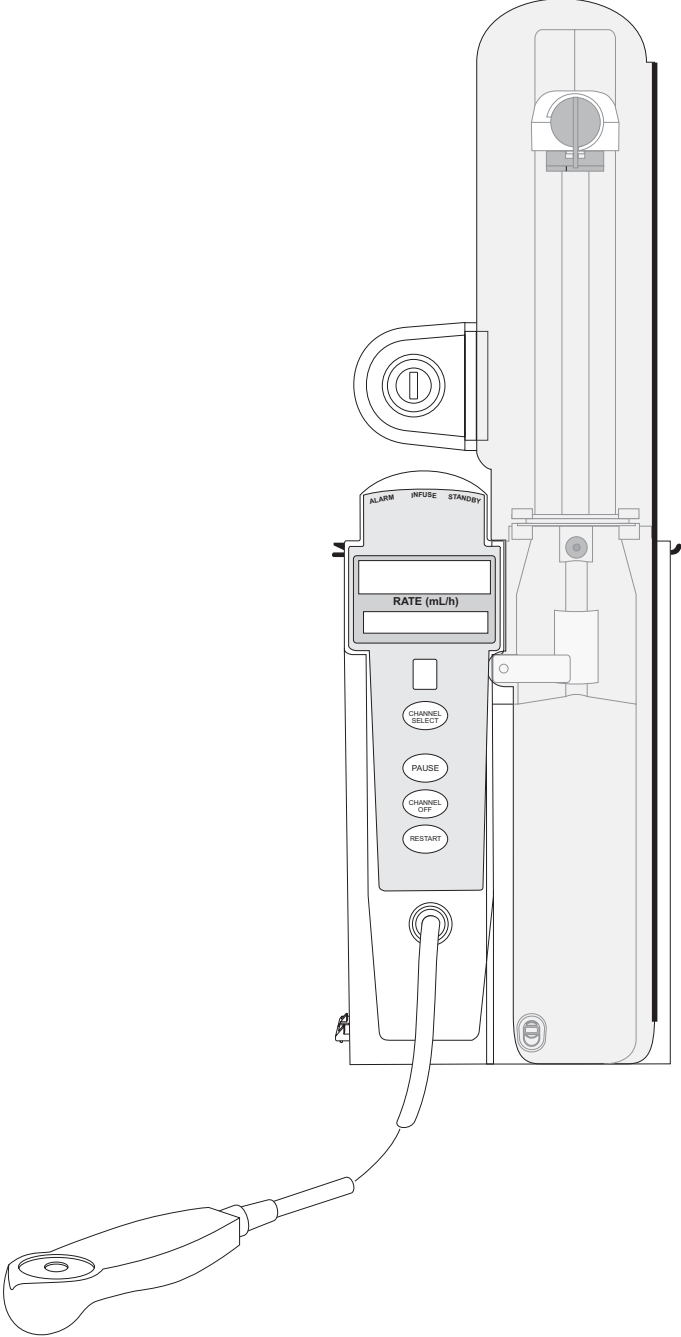

GETTING STARTED

INTRODUCTION.....	3-1
ATTACHING AND DETACHING DOSE REQUEST CORD.....	3-2
PREPARING AND LOADING SYRINGE AND ADMINISTRATION SET	3-3
Preparing Syringe and Administration Set.....	3-3
Loading Syringe and Administration Set.....	3-4
Security Lock Key Positions.....	3-6

PROGRAMMING

PREPARING INFUSION.....	3-7
Selecting Syringe Type and Size.....	3-7
Priming.....	3-8
Programming an Infusion.....	3-10
INFUSION MODES.....	3-12
Programming Parameters.....	3-12
Setting Up PCA Dose Only.....	3-13
Setting Up Continuous Infusion Only.....	3-15
Setting Up PCA Dose + Continuous Infusion.....	3-17
Setting Loading Dose Only.....	3-19
Setting Bolus Dose.....	3-20
Stopping a Loading, PCA or Bolus Dose.....	3-22
Changing Programming Parameters During an Infusion.....	3-22
Viewing Patient History.....	3-23
Clearing Patient History.....	3-24
Viewing Drug Event History.....	3-25
Configuring Dose Request Cord.....	3-26
Security Access Levels.....	3-27
Disabling Security Access Code.....	3-28
Pausing Infusion.....	3-28
Changing Syringe and Restoring Infusion.....	3-29
Stopping Infusion.....	3-31
Selecting Pressure Limit.....	3-31
Viewing and Clearing Volume Infused.....	3-32
PCA PAUSE PROTOCOL FEATURE	3-32
PROGRAMMING AN INFUSION WITH PCA PAUSE PROTOCOL ENABLED	3-33
REVIEWING OR CHANGING PCA PAUSE ALARM LIMITS	3-34
DISABLING PCA PAUSE ALARM.....	3-36

GENERAL SETUP AND OPERATION

SYSTEM START-UP / SETUP.....	3-37
------------------------------	------

GENERAL INFORMATION

WARNINGS AND CAUTIONS.....	3-39
General.....	3-39
Administration Sets.....	3-39
Epidural Administration.....	3-41
Dose Request Cord.....	3-41
Guardrails® Suite MX.....	3-42
ADMINISTRATION SET INFORMATION.....	3-42
COMPATIBLE SYRINGES.....	3-43

GENERAL INFORMATION (Continued)

FEATURES AND DISPLAYS.....	3-43
Features and Definitions.....	3-43
Operating Features, Controls, Indicators	3-47
Displays.....	3-48
CONFIGURABLE SETTINGS.....	3-48
SPECIFICATIONS AND SYMBOLS.....	3-50
Specifications	3-50
Symbols	3-52
TRUMPET AND START-UP CURVES.....	3-53

TROUBLESHOOTING AND MAINTENANCE

GENERAL.....	3-55
ALARMS, ERRORS, MESSAGES.....	3-55
Definitions	3-56
Alarms.....	3-56
Errors.....	3-58
Messages.....	3-58
INSPECTION REQUIREMENTS.....	3-60

Introduction

This Section of the DFU provides PCA Module (Model 8120) instructions and information. It is used in conjunction with:

- Alaris® product administration set instructions
- Drug product labeling
- PCA Module Set Compatibility Card
- PCA Module Technical Service Manual
- PC Unit Section of this DFU
- System Maintenance software (and its instructions) for Alaris® System check-in, maintenance, and wireless configuration

The PCA Module is intended for facilities that utilize syringe pumps for the delivery of medications or fluids. The PCA Module is indicated for use on adults, pediatrics and neonates for continuous or intermittent delivery through clinically acceptable routes of administration; such as, intravenous (IV), subcutaneous or epidural. Only one (1) PCA Module can be connected to the Alaris® System.

Administration Sets / Syringes: See "General Information" for specific administration set and syringe instructions.

- Administration Set Information
- Compatible Syringes

Alarms, Errors, Messages: See "Troubleshooting and Maintenance" for module-specific alarms, errors and messages.

Contraindications: None known.

Electromagnetic Environment: See "Appendix" Section of this DFU ("Regulations and Standards", "Compliance").

WARNING

Read all instructions, for both the PCA Module and PC Unit, before using the Alaris® System.

CAUTION

Rx Only

Attaching and Detaching Dose Request Cord

The Dose Request Cord must be attached to the PCA Module when delivering a PCA dose or PCA + continuous dose infusion.

WARNING

Carefully locate the Dose Request Cord to reduce the possibility of patient entanglement or strangulation.

To attach Dose Request Cord:

- Insert latching connector into Dose Request Cord attachment. Red marking on latching connector should be aligned with red marking on Dose Request Cord attachment.

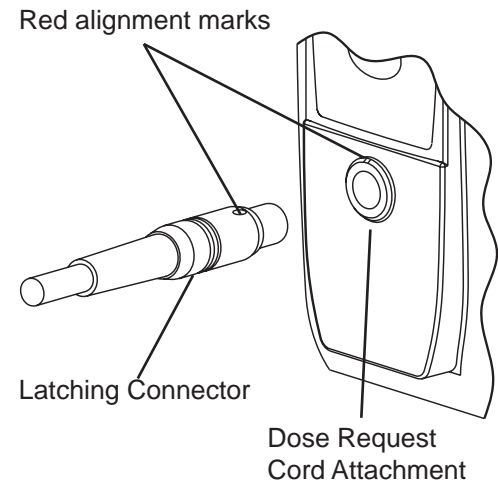

To detach Dose Request Cord:

- Hold body of latching connector and pull straight away, without twisting or turning, from Dose Request Cord attachment.

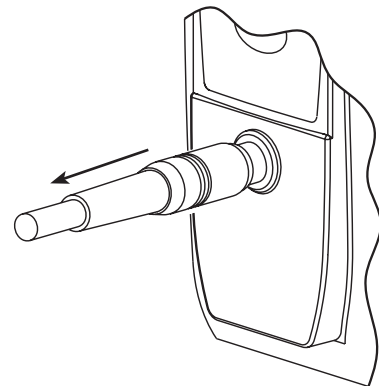

Preparing and Loading Syringe and Administration Set

For instructions on how to go from checking in a PCA Module to preparing it for an infusion setup, see "General Setup and Operation".

Preparing Syringe and Administration Set

1. Prepare syringe (see "General Information", "Compatible Syringes") in accordance with manufacturer's directions for use.
2. Prepare administration set (reference Set Compatibility Card, provided separately) in accordance with manufacturer's directions for use.
3. Attach upper fitting of administration set to syringe tip.

WARNING

Use only standard or pre-filled, single-use, disposable syringes (with luer-lock connectors) and nondedicated administration sets with integrated anti-siphon valves, designed for use on syringe-type PCA pumps. The use of any other **syringe or administration set** may cause improper instrument operation, resulting in inaccurate fluid delivery, pressure sensing, or other potential hazards. For a list of compatible syringes, see "General Information", "Compatible Syringes". For a list of compatible administration sets, reference the Set Compatibility Card (provided separately).

Preparing and Loading Syringe and Administration Set (Continued)

Loading Syringe and Administration Set

WARNINGS

- **Before loading** the syringe, check it for damage or defects.
- Ensure syringe barrel, flange, and plunger are installed and secured correctly. Failure to **install syringe correctly** can result in uncontrolled fluid flow to the patient, and may cause serious injury or death.
- **Before loading or unloading** the syringe, always turn off fluid flow to the patient, using the tubing clamp or stopcock. Uncontrolled fluid flow can occur when the administration set is not clamped or turned off, and may cause serious injury or death.

CAUTION

When initially loading the syringe, allow for the volume of fluid contained in the administration set and retained in the syringe at the end of an infusion, as this "dead space" will not be infused.

1. Open syringe barrel clamp.
 - a. Pull syringe barrel clamp out and hold.
 - b. Rotate clamp to left (clockwise or counter clockwise) until it clears syringe chamber.
 - c. Gently release clamp.

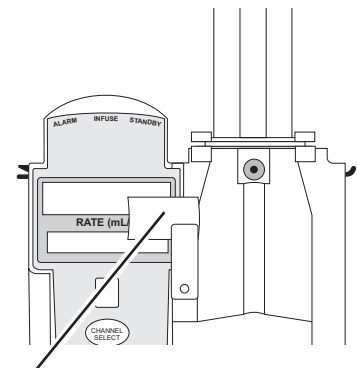

Syringe Barrel Clamp Open

Preparing and Loading Syringe and Administration Set (Continued)

Loading Syringe and Administration Set (Continued)

2. Raise drive head to its fully extended position.
 - a. Twist gripper control clockwise and hold in position. ①
 - b. While holding gripper control in open position, raise drive head to full extension.
 - c. Gently release gripper control.

Drive Head Fully Extended

Gripper Control / Drive Head Release in Open Position

Plunger Grippers Open

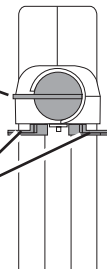

3. Insert syringe (from front of instrument) by sliding flat edge of syringe barrel flange between barrel flange grippers.

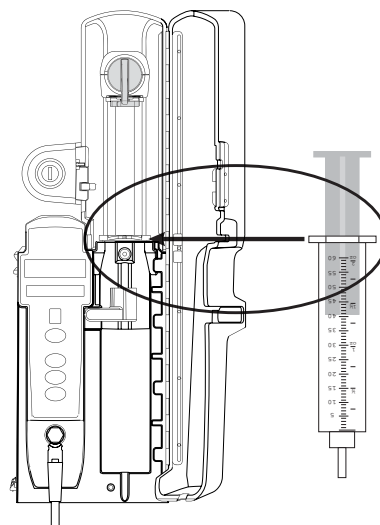
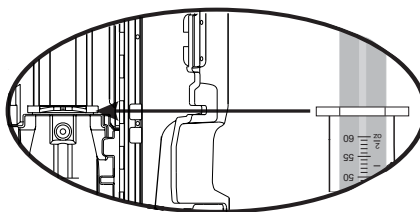

4. Lock syringe in place.
 - a. Pull syringe barrel clamp out and hold.
 - b. Rotate clamp to right (clockwise or counter clockwise) until it lines up with syringe.
 - c. Gently release clamp against syringe.

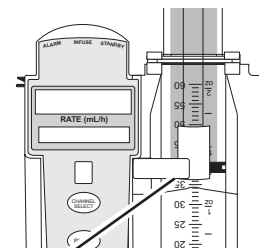

Syringe Barrel Clamp Closed

Preparing and Loading Syringe and Administration Set (Continued)

Loading Syringe and Administration Set (Continued)

5. Lower drive head and lock plunger in place with plunger grippers.
 - a. Twist gripper control clockwise and hold in position. ①
 - b. While holding gripper control in open position, gently lower drive head until it makes contact with plunger flange.
 - c. Gently release gripper control.
 - d. Ensure plunger grippers lock and hold plunger in place.

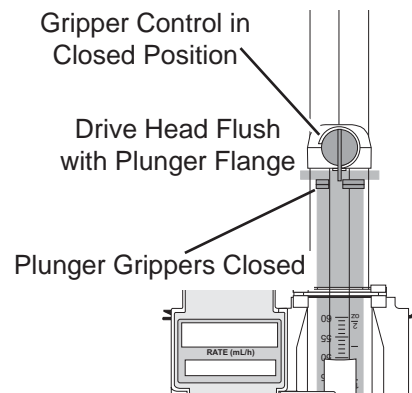

NOTE:

- ① The gripper control is spring loaded. When twisted to the open position and then released, it (and the plunger grippers) returns to the closed position.

Security Lock Key Positions

There are 3 key positions associated with the security lock:

- UNLOCK unlocks security door. Key must be in this position when loading or changing a syringe.
- PROGRAM allows for changes in programming without unlocking security door or interrupting current infusion.
- LOCK locks security door. Key must be in this position to start an infusion.

References throughout this procedure to specific drugs and drug doses are for illustration purposes only. Reference specific drug product labeling for information concerning appropriate administration techniques and dosages.

See "General Information", "Features and Displays" and the PC Unit Section of this DFU for information about:

- Displays
- Operating Features, Controls, Indicators

Preparing Infusion

Selecting Syringe Type and Size

At the start of an infusion program, the system prompts user to select and confirm the syringe type and size. ^①

WARNING

Ensure the displayed **syringe manufacturer and size** correctly identifies the installed syringe. Mismatches may cause an under-infusion or over-infusion to the patient that could result in serious injury and/or death. For a list of compatible syringes, see "General Information", "Compatible Syringes". If the installed syringe is displayed and selected, but is not recognized, servicing is required (see "Service Information" in "Appendix" Section of this DFU).

1. Press **CHANNEL SELECT** key. Key must be in **PROGRAM** position.

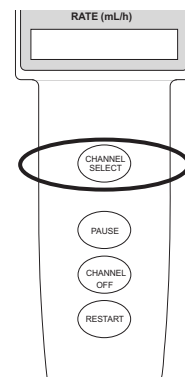

Preparing Infusion (Continued)

Selecting Syringe Type and Size (Continued)

- Press soft key next to installed syringe type and size.
 - If installed syringe is not listed, press **ALL SYRINGES** soft key and select syringe from list. ①
 - Selection is highlighted.
 - CONFIRM** soft key is activated.

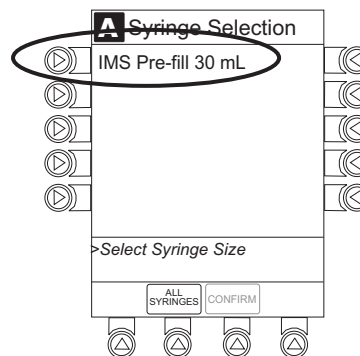

- To accept, press **CONFIRM** soft key.
 - Drug Library screen displays.

NOTE:

- ① The system automatically detects the syringe size, and lists syringe types and sizes that most closely match the installed syringe. If the syringe is not recognized, **Syringe not recognized** displays.

Priming

The Priming option can be enabled at the time the Alaris® System is configured for use. The Priming selection (**PRIME** soft key) is available only after the syringe type and medication selection (prior to infusion mode selection).

WARNING

When priming:

- Ensure patient is not connected.
- Ensure air is expelled from line prior to beginning infusion (unexpelled air in line could have serious consequences).

Failure to prime correctly can delay infusion delivery and cause the total volume to be infused to read higher than the actual total delivered to the patient.

CAUTION

During priming, the pressure limit alarms are temporarily increased to their maximum level.

Selecting Syringe Type and Size (Continued)

Priming (Continued)

1. Press **OPTIONS** key.

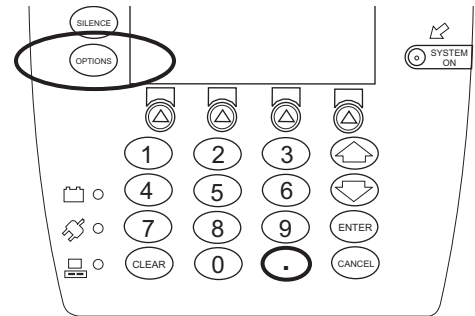

2. Press **Prime Set with Syringe** soft key.

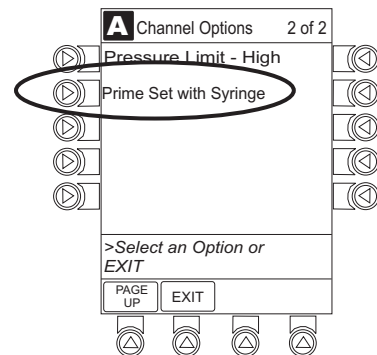

3. Press and hold **PRIME** soft key until fluid flows and priming of syringe administration set is complete. ^①
 - Volume used during priming is displayed but not added to **VTBI**.

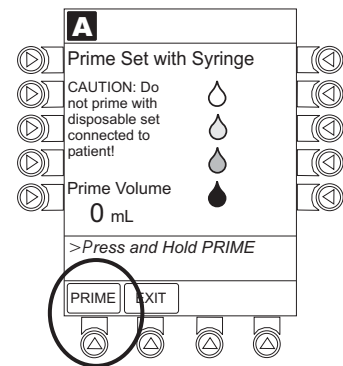

Preparing Infusion (Continued)

Priming (Continued)

- When priming is complete, release **PRIME** soft key.
- To return to main screen, press **EXIT** soft key.
 - Guardrails Drug Setup** screen displays.
- Select infusion mode.

NOTE:

- ① Fluid is delivered during priming only while the **PRIME** soft key is pressed. Each press of the **PRIME** soft key delivers up to 2 mL of priming/fluid per continuous press. To deliver additional amounts, press the **PRIME** soft key again.

Programming an Infusion

- Perform steps in "Getting Started", "Preparing Syringe and Administration Set".
- Perform following steps (see PC Unit Section of this DFU, "General Setup and Operation", "Startup"):
 - Power on system.
 - Choose **Yes** or **No** to **New Patient?**
 - Select profile, if required.
 - Enter patient identifier, if required.
- Press **CHANNEL SELECT** key.
- Unlock security door or set key to **PROGRAM** position.
- Confirm time of day or change time if necessary.

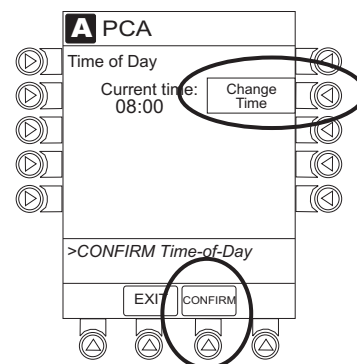

Preparing Infusion (Continued)

Programming an Infusion (Continued)

6. Perform following steps:
 - a. Load syringe and administration set (see "Getting Started", "Loading Syringe and Administration Set").
 - b. Select and confirm syringe type and size (see "Selecting Syringe Type and Size").
7. Press soft key next to desired drug.
 - Drug/Concentration screen appears.

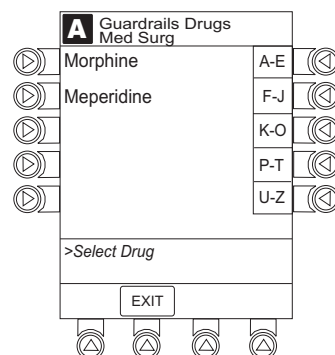

8. Press soft key next to desired concentration.
 - Drug/Concentration confirmation screen appears.
 - To view additional drugs/concentrations, press **PAGE UP** and **PAGE DOWN** soft keys.
 - Facility may choose to prepopulate standard drug concentrations, or leave an open entry (_ _ / _ _ mL) and allow clinician to enter drug amount and diluent volume.

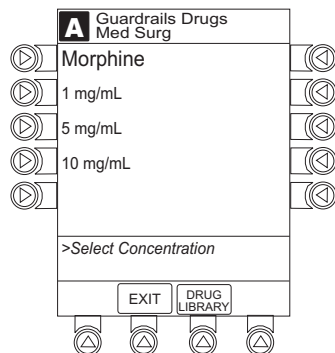

9. Confirm drug and concentration selection and press **Yes** soft key. To change selection, press **No** soft key. ① ② ③
 - If **Yes** was selected and facility has defined a Clinical Advisory for that drug, a message appears. To continue programming, press **CONFIRM** soft key.
10. Verify parameters are correct and press **NEXT** soft key to confirm.
11. Prime syringe using Prime feature, if desired.

Preparing Infusion (Continued)

Programming an Infusion (Continued)

NOTES:

- ① If the programmed "__ / __ mL" concentration is outside the Soft Limit, an audio alert sounds and a visual prompt appears before programming can continue. If the **Yes** soft key is pressed, programming continues; if the **No** soft key is pressed, the infusion must be reprogrammed.
- ② If the programmed "__ / __ mL" concentration is outside the Hard Limit for that care area, an audio alert sounds and a visual prompt appears before programming can continue. The drug amount and diluent volume must be reprogrammed.
- ③ If a Soft Limit is overridden, the **G** icon displays. When the **G** soft key is pressed, all applicable out-of-range limits are listed.

Infusion Modes

Programming Parameters

The PCA Module uses the following programming parameters, depending on infusion mode selected. See "General Information", "Features and Definitions" for infusion mode definitions and features. ①

- **PCA Dose:** patient self-administered dose.
- **Lockout Interval:** programmed time elapse between availability of PCA doses.
- **Continuous Dose:** basal rate dose.
- **Max Limit:** (optional) total amount of drug which can be infused over a specified time period.
- **Loading Dose:** (optional) bolus dose infused prior to initiation of PCA infusion.
- **Bolus Dose:** (optional) additional dose programmed after the initiation of PCA infusion.

NOTE:

- ① When the PC Unit is in the Infusion Mode Selection, Infusion Setup or Bolus Setup screens, a patient dose request from the Dose Request Cord is handled as an unmet demand.

Infusion Modes (Continued)

Setting Up PCA Dose Only

1. Perform steps in "Preparing Infusion".
2. Press **PCA Dose Only** soft key from Infusion Mode screen.

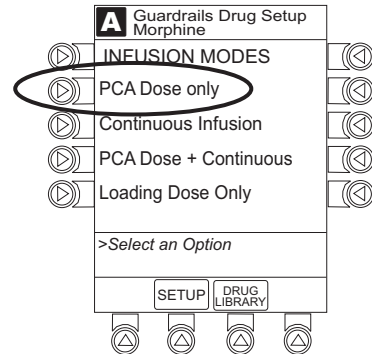

3. To enter PCA dose, use numeric data entry keys.

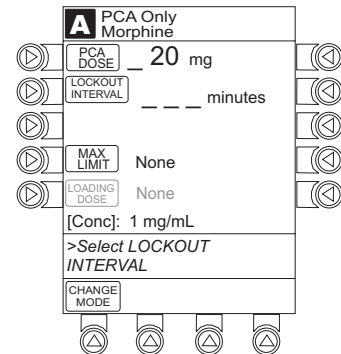

4. To enter lockout interval, press **LOCKOUT INTERVAL** soft key and use numeric data entry keys.
5. To enter maximum limit, press **MAX LIMIT** soft key and then **Yes** soft key.

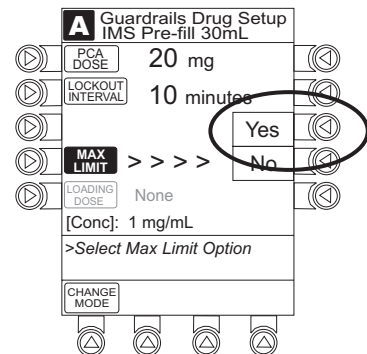

Infusion Modes (Continued)

Setting Up PCA Dose Only (Continued)

6. Enter maximum limit using numeric data entry keys. ^①
7. To enter loading dose, press **LOAD DOSE** soft key, press **Yes** soft key and use numeric data entry keys. ^②
8. Verify parameters are correct and press **CONFIRM** soft key.
 - If programmed parameters are outside Soft Limit, an audio alert sounds and a visual prompt appears before programming can continue. If **Yes** soft key is pressed, programming continues; if **No** soft key is pressed, infusion must be reprogrammed.
 - If programmed parameters are outside Hard Limit for that care area, an audio alert sounds and a visual prompt appears before programming can continue. Infusion must be reprogrammed.
 - If a Soft Limit is overridden, **G** icon displays. When **G** soft key is pressed, all applicable out-of-range limits are listed.
9. Close and lock security door.
10. Verify parameters on second nurse summary screen are correct and press **START** soft key.
 - Infusion mode and PCA drug name scroll in Channel Message Display. If a loading dose has been entered, scrolls **DELIVERING LOAD**.
 - Main Display alternates between volume remaining and PCA drug name with infusion mode.
 - When PCA dose is delivered:
 - ◆ Green Infusing Status Indicator illuminates.
 - ◆ Rate display flashes "_____".
 - ◆ **DELIVERING PCA** scrolls in channel message display.
 - ◆ When PCA dose is complete, **PCA COMPLETE** scrolls in Channel Message Display.

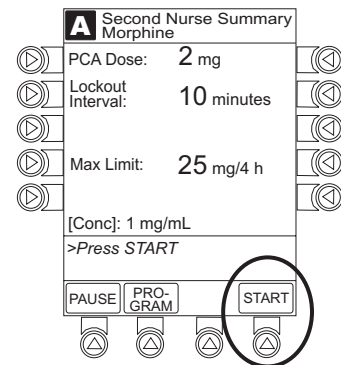
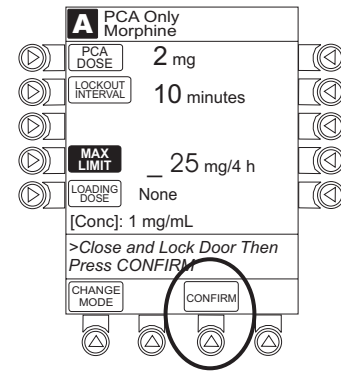

NOTES:

- ① Time (in hours) associated with **Max Limit** is automatically entered based on setup in system configuration.
- ② Loading dose is included in volume infused but is not included in **Max Limit**.

Infusion Modes (Continued)

Setting Up Continuous Infusion Only

1. Perform steps in "Preparing Infusion".
2. Press **CONTINUOUS INFUSION** soft key from Infusion Mode screen.

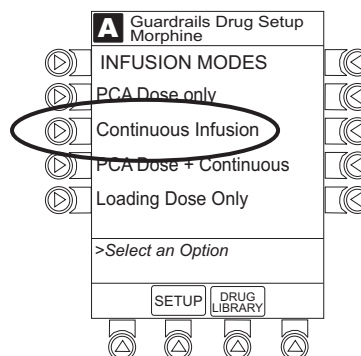

3. To enter continuous infusion dose, press **CONT DOSE** soft key and use numeric data entry keys.

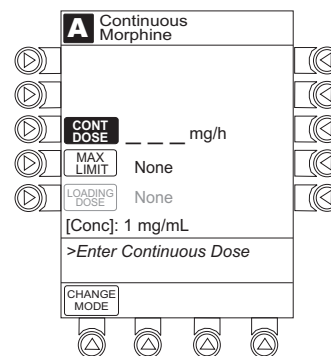

4. To enter maximum limit, press **MAX LIMIT** soft key, press **Yes** soft key and use numeric data entry keys. ^①

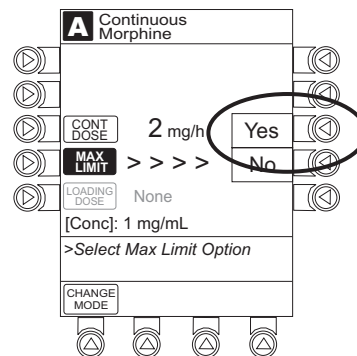

Infusion Modes (Continued)

Setting Up Continuous Infusion Only (Continued)

5. To enter loading dose, press **LOAD DOSE** soft key, press **Yes** soft key and use numeric data entry keys. ^②
6. Verify parameters are correct and press **CONFIRM** soft key.
 - If programmed parameters are outside Soft Limit for that care area, an audio alert sounds and a visual prompt appears before programming can continue. If **Yes** soft key is pressed, programming continues; if **No** soft key is pressed, infusion needs to be reprogrammed.
 - If programmed parameters are outside Hard Limit for that care area, an audio alert sounds and a visual prompt appears before programming can continue. Infusion needs to be reprogrammed.
 - If a Soft Limit is overridden, **G** icon displays. When **G** soft key is pressed, all applicable out-of-range limits are listed.
7. Close and lock security door.
8. Verify programming parameters are correct and press **START** soft key.
 - Green Infusing Status Indicator illuminates.
 - Infusion mode and drug name scroll in Channel Message Display. If a loading dose has been entered, **DELIVERING LOAD** scrolls.
 - Volume infused in mL/h in Rate Display.
 - Main Display alternates between volume remaining and infusion mode with drug name.

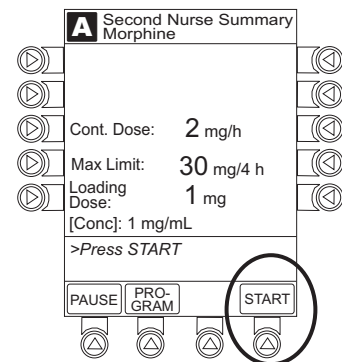
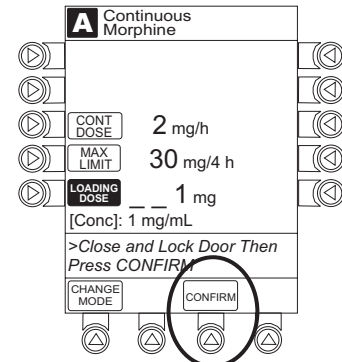

NOTES:

- ① Time (in hours) associated with **Max Limit** is automatically entered based on setup in system configuration.
- ② Loading dose is included in volume infused but is not included in **Max Limit**.

Infusion Modes (Continued)

Setting Up PCA Dose + Continuous Infusion

1. Perform steps in "Preparing Infusion".
2. Press **PCA DOSE + CONTINUOUS** soft key from Infusion Mode screen.

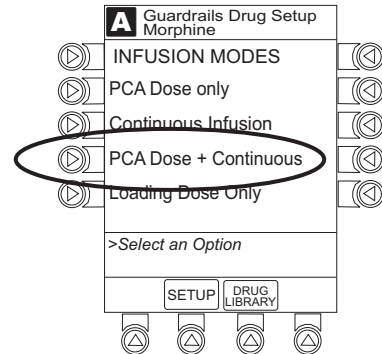

3. To enter PCA dose, press **PCA DOSE** soft key and use numeric data entry keys.

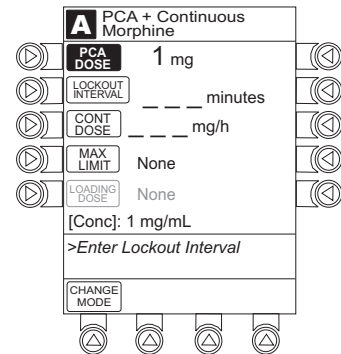

4. To enter lockout interval, press **LOCKOUT INTERVAL** soft key and use numeric data entry keys.
5. To enter continuous dose, press **CONT DOSE** soft key, and use numeric data entry keys.
6. To enter maximum limit, press **MAX LIMIT** soft key, press **Yes** soft key and use numeric data entry keys. ^①

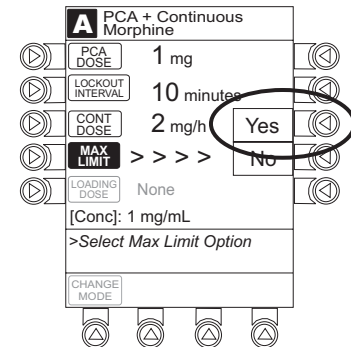

Infusion Modes (Continued)

Setting Up PCA Dose + Continuous Infusion (Continued)

7. To enter loading dose, press **LOAD DOSE** soft key, press **Yes** soft key and use numeric data entry keys. ②
8. Verify parameters are correct and press **CONFIRM** soft key.
 - If programmed parameters are outside Soft Limit for that care area, an audio alert sounds and a visual prompt appears before programming can continue. If **Yes** soft key is pressed, programming continues; if **No** soft key is pressed, infusion needs to be reprogrammed.
 - If programmed parameters are outside Hard Limit for that care area, an audio alert sounds and a visual prompt appears before programming can continue. Infusion needs to be reprogrammed.
 - If a Soft Limit is overridden, **G** icon displays. When **G** soft key is pressed, all applicable out-of-range limits are listed.
9. Close and lock security door.
10. Verify parameters on second nurse summary screen are correct and press **START** soft key.

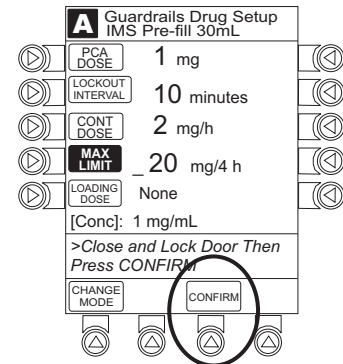

- During PCA dose + continuous infusion:
 - ◆ Green Infusing Status Indicator illuminates.
 - ◆ **DELIVERING PCA** scrolls in Channel Message Display when initiated. Continuous and PCA drug name scrolls in Channel Message Display between PCA doses.
 - ◆ Volume infused for continuous dose is displayed in mL/h in Rate Display.
 - ◆ Main Display alternates between volume remaining and infusion mode with PCA drug name.
 - ◆ When PCA dose is complete, **PCA COMPLETE** scrolls in Channel Message Display and resumes continuous dose.

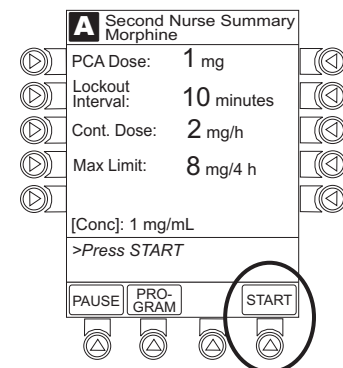

NOTES:

- ① Time (in hours) associated with **Max Limit** is automatically entered based on setup in system configuration.
- ② Loading dose is included in VTBI but is not included in **Max Limit**.

Infusion Modes (Continued)

Setting Loading Dose Only

The following procedures should be used when setting a **LOADING DOSE ONLY** using the Drug Library.

Setting Loading Dose from Infusion Mode Screen

1. Perform steps in "Preparing Infusion".
2. Press **LOADING DOSE ONLY** soft key from Infusion Mode screen.
3. To enter dose value, use numeric data entry keys.
4. Verify dose value is correct and then press **CONFIRM** soft key. ^①
 - If programmed loading dose is outside Soft Limit for that care area, an audio alert sounds and a visual prompt appears before programming can continue. If **Yes** soft key is pressed, programming continues; if **No** soft key is pressed, infusion needs to be reprogrammed.
 - If programmed loading dose is outside Hard Limit for that care area, an audio alert sounds and a visual prompt appears before programming can continue. Infusion must be reprogrammed.
 - If a Soft Limit is overridden, **G** icon displays. When **G** soft key is pressed, all applicable out-of-range limits are listed.
5. Close and lock security door.
6. Verify parameters on summary screen are correct and press **START** soft key.
 - **DELIVERING LOAD** scrolls in Channel Message Display.
 - Infusion mode and drug name alternate with VTBI in Main Display.
 - When loading dose is complete, **The Loading Dose has Completed** appears on Main Display.

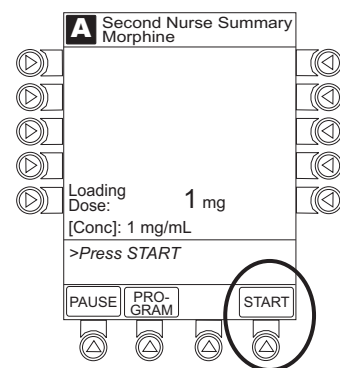
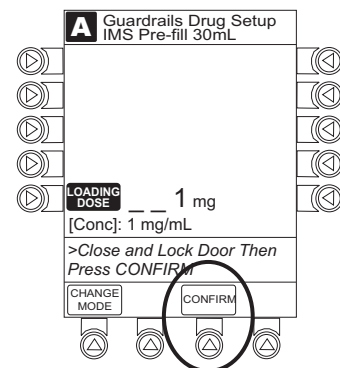

Infusion Modes (Continued)

Setting Loading Dose Only (Continued)

Setting Loading Dose from Infusion Mode Screen (Continued)

7. Press **CONFIRM** soft key.
 - Upon pressing Channel Select on PCA Module, Infusion Mode screen becomes available for selection of infusion mode.

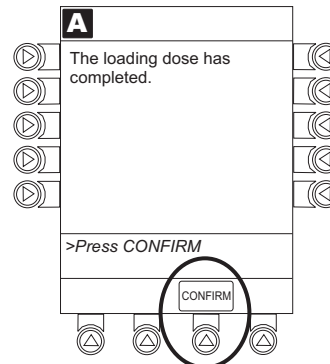

NOTE:

- ① Loading dose is included in the VTBI but is not included in the **Max Limit**.

Setting Bolus Dose

The following procedures should be used only when setting a **BOLUS DOSE** using the Drug Library. ①

1. Press **CHANNEL SELECT**.
2. Press **BOLUS DOSE** soft key.

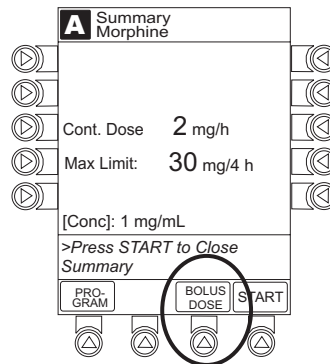

3. Set key to **PROGRAM** position or enter 4-digit authorization code and press **CONFIRM** soft key.
4. To enter dose value, use numeric data entry keys.

Infusion Modes (Continued)

Setting Bolus Dose (Continued)

5. Press **CONFIRM** soft key.
 - If programmed bolus dose is outside Soft Limit for that care area, an audio alert sounds and a visual prompt appears before programming can continue. If **Yes** soft key is pressed, programming continues; if **No** soft key is pressed, infusion needs to be reprogrammed.
 - If programmed bolus dose is outside Hard Limit for that care area, an audio alert sounds and a visual prompt appears before programming can continue. Infusion needs to be reprogrammed.
 - If a Soft Limit is overridden, **G** icon displays. When **G** soft key is pressed, all applicable out-of-range limits are listed.
6. If Authorization Code is disabled, door must be locked prior to starting bolus dose.
7. Verify dose value is correct and then press **START** soft key:
 - **Delivering Bolus** scrolls in Channel Message Display
 - Bolus and drug name alternate with VTBI in Main Display
 - When bolus dose is complete, **BOLUS COMPLETE** scrolls in Channel Message Display.
 - Programmed infusion resumes.

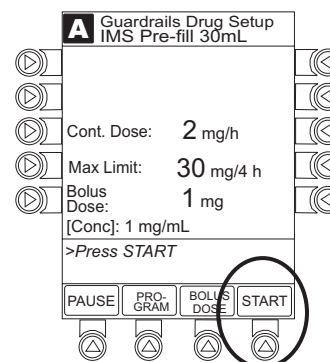

NOTE:

- ① The **BOLUS DOSE** soft key is only available once an infusion has begun in PCA dose only, continuous infusion, or PCA + continuous infusion modes.

Infusion Modes (Continued)

Stopping a Loading, PCA or Bolus Dose

1. Press **CHANNEL SELECT** key.
2. Press **STOP LOAD**, **STOP PCA** or **STOP BOLUS** soft key as applicable. ^①

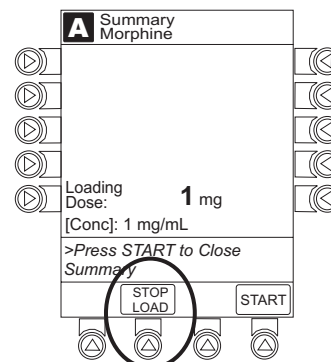

3. To stop dose and resume current program, press **Yes** soft key.

NOTE:

- ① Available soft key and stop confirmation screen are dependent on the type of dose currently infusing and current infusion mode.

Changing Programming Parameters During an Infusion

1. Press **CHANNEL SELECT** key.
2. Press **PROGRAM** soft key.
3. Set key to program position or if Authorization Code is enabled, enter 4-digit code.
4. Press **CHANGE MODE** soft key.

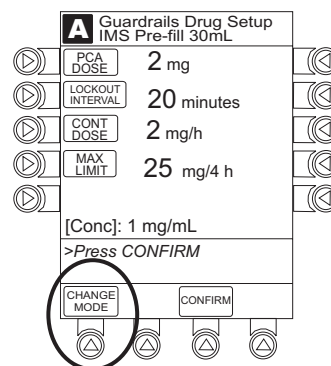

5. Select desired infusion mode.
6. Continue programming. See applicable procedure: ^①

Setting Up PCA Dose Only
 Setting Up Continuous Infusion Only
 Setting Up PCA + Continuous Infusion

Infusion Modes (Continued)

Changing Programming Parameters During an Infusion (Continued)

7. Verify or change program settings and press **CONFIRM** soft key.
8. Close and lock door.
9. Verify programming parameters on summary screen are correct and press **START** soft key.

NOTE:

- ① Previously programmed values are carried over to new program.

Viewing Patient History

1. Press **CHANNEL SELECT** key.
2. From Main Display, press **OPTIONS** key.
3. Press **Patient History** soft key.

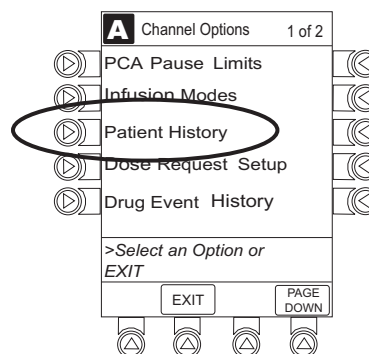

4. To select desired time period, press **ZOOM** soft key. ①

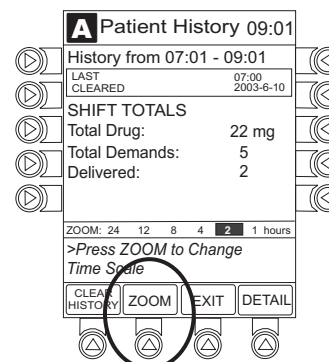

Infusion Modes (Continued)

Viewing Patient History (Continued)

- To view detailed patient history, press **DETAIL** soft key.
- To return to main patient history, press **MAIN HISTORY** soft key.
- To return to Main Display, press **EXIT** soft key. ②

NOTES:

- ① Total drug delivered includes applicable loading dose, PCA dose, continuous dose, and bolus dose. Total drug delivered does not include priming volume.
- ② Patient history stores a rolling 24-hour log and is automatically cleared upon selection of **New Patient?**, **Yes** during start-up or upon changing drug selection in Drug Library.

Clearing Patient History

- Press **CHANNEL SELECT** key.
- From Main Display, press **OPTIONS** key.
- Press **Patient History** soft key.
- Press **CLEAR HISTORY** soft key.
 - A confirmation screen appears.
- To continue and clear patient history, press **Yes** soft key.
To cancel and return to patient history, press **No** soft key.

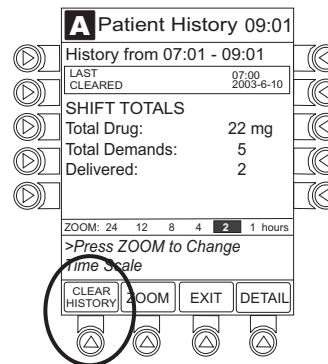

Infusion Modes (Continued)

Clearing Patient History (Continued)

- Once patient history is cleared, last 24 hours of patient history data may be retrieved and viewed. To retrieve last 24 hours, select **24 h Totals** soft key from **Patient History** screen. ^①

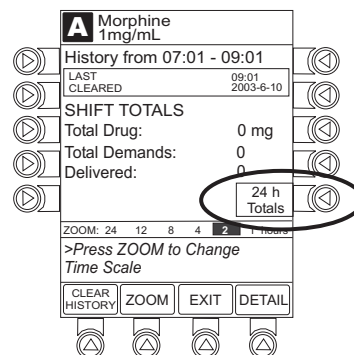

- To return to **Patient History** screen, press **SHIFT TOTALS** soft key.

NOTE:

- The **24 h Totals** soft key appears only if the shift total is cleared and additional patient history information exists (up to the previous 24 hours).

Viewing Drug Event History

- Press **CHANNEL SELECT** key.
- From Main Display, press **OPTIONS** key.
- Press **Drug Event History** soft key.

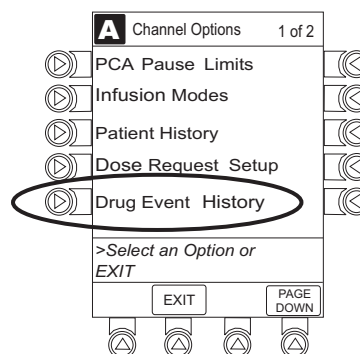

Infusion Modes (Continued)

Viewing Drug Event History (Continued)

- To scroll through history, press **PAGE DOWN** soft key.
- To return to Main Display, press **EXIT** soft key. ①

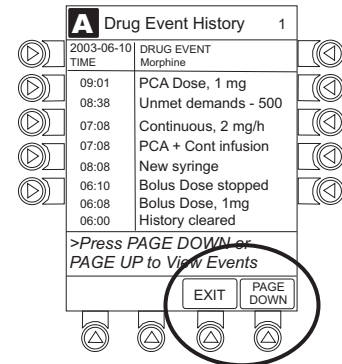

NOTE:

- The **Drug Event History** stores approximately 12 hours of events and is automatically cleared upon selection of **New Patient?, Yes** during start-up or upon changing drug in Drug Library.

Configuring Dose Request Cord

The Dose Request Cord can be configured to provide both audio and visual prompts to the patient. Visual prompts are provided through the LED indicator on the Dose Request Cord. Default configuration for the Dose Request Cord is established in the system configuration.

To change Dose Request Cord configuration:

- Press **CHANNEL SELECT** key.
- From Main Display, press **OPTIONS** key.
- Press **DOSE REQUEST SETUP** soft key.

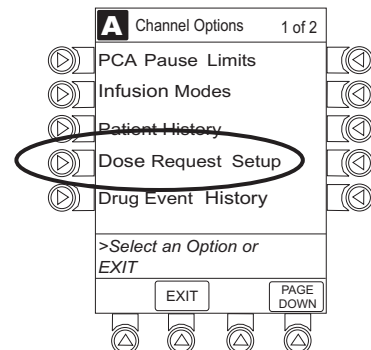

Infusion Modes (Continued)

Configuring Dose Request Cord (Continued)

4. Review and select **Profile** soft key for desired operation of Dose Request Cord.

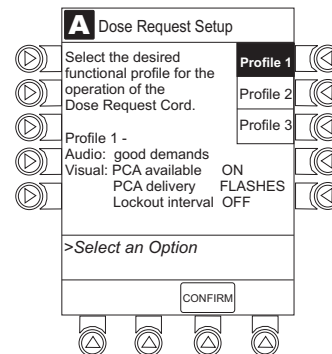

	Profile 1	Profile 2	Profile 3
Dose request cord audio - single beep	met demands only	all demands	all demands
Dose request cord LED indicator:			
PCA available	ON	ON	OFF
PCA delivery	"ON-FLASHING"	ON	OFF
Lockout interval	OFF	ON	OFF

5. Press **CONFIRM** soft key.

Security Access Levels

The security access level can be configured to provide varying levels of access to the device. Security access is accomplished either through the use of the key or a 4-digit authorization code.

Default configuration for the security access level is established for each profile or care area and can be changed in the system configuration. The 4-digit authorization code is established and can be changed in the system configuration.

The 4-digit authorization code is configured for each profile with Level 2 or Level 3 security access.

Security Access Level	Initial Programming	Setting Bolus Dose	Subsequent Programming
Level 1	Key	Key	Key
Level 2	Key	Code or Key	Key
Level 3	Key	Code or Key	Code or Key

Infusion Modes (Continued)

Disabling Security Access Code

The security code may be disabled for a specific infusion by using the following procedure:

1. Press **CHANNEL SELECT** key.
2. From Main Display, press **OPTIONS** key.
3. Press **Security Code Access** soft key.

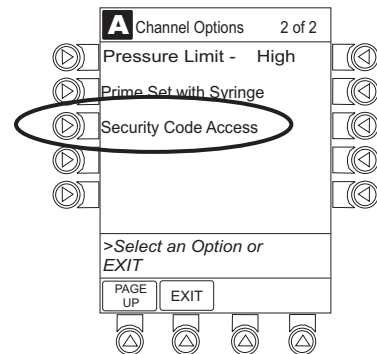

4. Press **DISABLE CODE** soft key.
5. Press **CONFIRM** soft key.
 - Security access code remains disabled until **New Patient?, Yes** is selected in infusion startup or when instrument remains powered off for more than 8 hours.

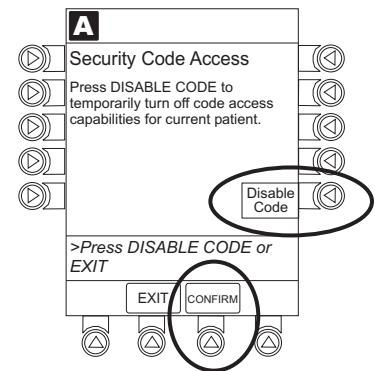

Pausing Infusion

1. Press **PAUSE** key.
OR

-- Continued on Next Page --

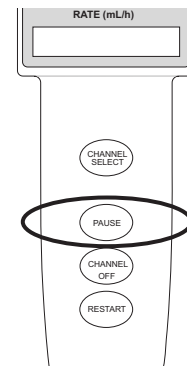

Infusion Modes (Continued)

Pausing Infusion (Continued)

From **Second Nurse Summary** screen, press **PAUSE** soft key.

- **PAUSE** scrolls in Channel Message Display.
- **PAUSED** appears on Main Display.
- Yellow Standby Status Indicator illuminates.
- After 2 minutes, **PAUSE-RESTART CHANNEL** visual and audio prompts begin, and yellow Standby Status Indicator flashes.

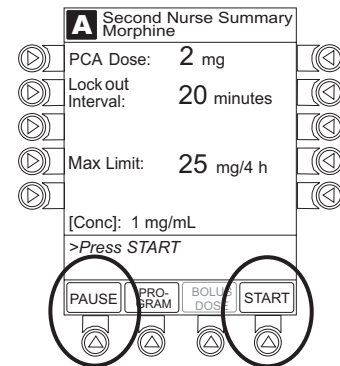

2. To reinitiate infusion:

- Press **RESTART** key.
OR
- Press **CHANNEL SELECT** key and then press **START** soft key on Main Display.

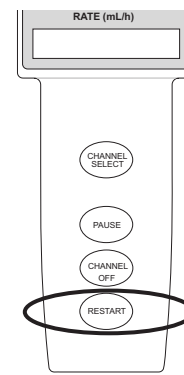

Changing Syringe and Restoring Infusion

1. If syringe requires replacement:
 - a. Unlock security door.
 - b. Remove existing syringe and prepare new syringe (see "Getting Started", "Preparing and Loading Syringe and Administration Set").^①
 - c. Load syringe and administration set (see "Getting Started", "Preparing and Loading Syringe and Administration Set", "Loading Syringe and Administration Set").
 - d. Select syringe type and size (see "Preparing Infusion", "Selecting Syringe Type and Size").

Infusion Modes (Continued)

Changing Syringe and Restoring Infusion (Continued)

- To restart infusion using restored parameters, press **RESTORE** soft key and continue with next step.
OR
To start a new infusion, select drug from Drug Library and follow steps for "Infusion Modes".

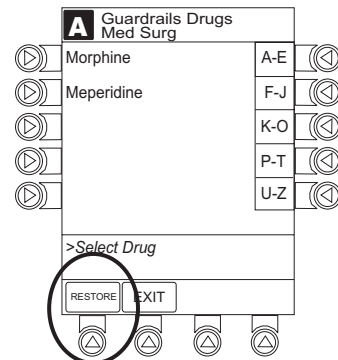

- Verify restored drug/concentration. Press **NEXT** soft key.
- Prime administration set (see "Preparing Infusion", "Priming").
- For restored parameters, verify parameters are valid and press **CONFIRM** soft key. ②
- Close and lock security door.
- Verify programming parameters on summary screen are correct and press **START** soft key.

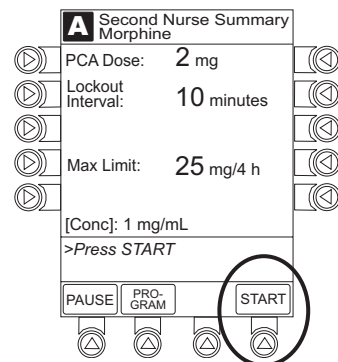

NOTES:

- If drug and/or drug concentration is different from previous syringe, attach and prime new administration set.
- To change a restored parameter:
 - Press applicable soft key.
 - Enter desired parameter using numeric data entry keys.
 - Press **CONFIRM** soft key.

Infusion Modes (Continued)

Stopping Infusion

Press and hold **CHANNEL OFF** key until a beep is heard, approximately 1.5 seconds. ①

NOTE:

- ① If no other channel is active, the system powers down when the **CHANNEL OFF** key is released.

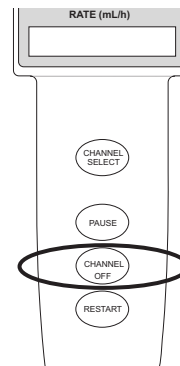

Selecting Pressure Limit

1. Press **CHANNEL SELECT** key.
2. Press **OPTIONS** key.
3. Press **Pressure Limit** soft key. ①

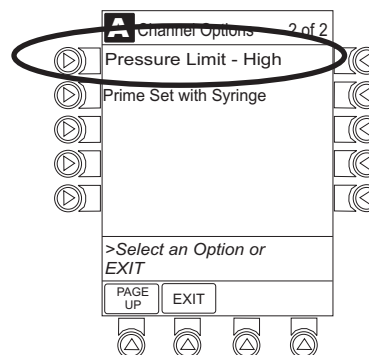

4. To select a pressure limit, press appropriate soft key.
5. Press **CONFIRM** soft key.

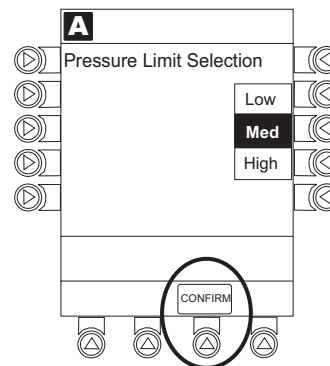

NOTE:

- ① Option to change pressure limit can be selected:
- after drug is selected, and before infusion mode is selected and infusion starts, or
 - after infusion starts.

Infusion Modes (Continued)

Viewing and Clearing Volume Infused

- To view volume infused, press **VOLUME INFUSED** soft key from Main Display.
 - Total volume infused, and time and date volume infused was last cleared, is displayed for each channel. ①
- To clear volume infused: ② ③
 - If only selected channels are to be cleared, press soft key next to applicable channel(s) and press **CLEAR CHANNEL** soft key.
 - If all channels are to be cleared, press **CLEAR ALL** soft key.
- To return to main screen, press **MAIN SCREEN** soft key.

Volume Infused		
TOTAL VOLUME (mL)	LAST CLEARED	
A	401.10	08:00 1998-3-10
B	42.50	07:30 1998-3-11
C	478.10	08:00 1998-3-10
D	789.10	12:00 1998-3-10

>Select Channels to Clear
or Press CLEAR ALL

PRIME VOLUME	CLEAR ALL	MAIN SCREEN
-----------------	--------------	----------------

NOTES:

- ① Date format is year-month-day.
- ② If no key is pressed, main screen appears after 30 seconds.
- ③ Clearing volume infused on a PCA Module does not clear patient history.

PCA Pause Protocol Feature

The PCA Pause Protocol is an optional, hospital-configurable feature that is intended to align with the healthcare facility's current protocol for patient monitoring during PCA Therapy. All programming, data entry and validation of PCA Pause Protocol parameters are performed by a healthcare professional according to hospital-defined protocol/procedure or a physician's order.

Programming an Infusion with PCA Pause Protocol Enabled

1. Perform steps 1-8 in "Preparing Infusion", "Programming an Infusion".
2. Confirm drug and concentration selections and press **Yes** soft key.
3. If facility has chosen to enable optional PCA Pause Protocol, review Clinical Advisory. To continue, press **CONFIRM** soft key.

To activate PCA Pause Protocol, attach and start an EtCO₂ Module and/or SpO₂ Module per facility protocol.

- Verify appropriate monitoring modules are attached to PC Unit and press **CONFIRM** soft key. ^①

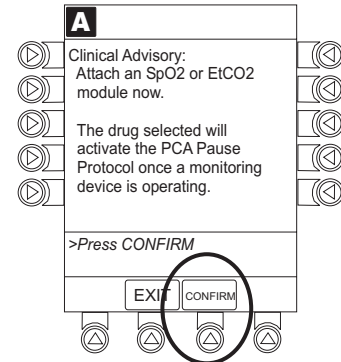

4. Verify parameters are correct and press **next** soft key to confirm.
 - Clinical Advisory appears.
5. Press **CONFIRM** soft key. ^②

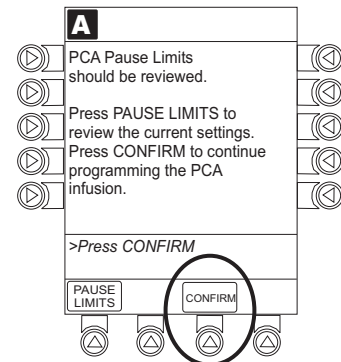

6. Start applicable infusion, as described in following procedures: ^③

Setting Up PCA Dose Only
Setting Up Continuous Infusion Only
Setting Up PCA Dose + Continuous Infusion
Setting Loading Dose Only

Programming an Infusion with PCA Pause Protocol Enabled (Continued)

NOTES:

- ① If a monitoring module(s) is not attached or started, the PCA Pause Protocol does not activate.
- ② To review PCA pause limits, see "Reviewing or Changing PCA Pause Alarm Limits".
- ③ Once the **START** soft key is pressed, the Main Display screen alternates between volume remaining (VTBI - Volume to be Infused) and PCA drug name with the infusion code.
 - The Main Display displays **PCA Pause Protocol ON**.
 - If Patient ID is entered, **Patient ID** alternates with **PCA Pause Protocol ON**.

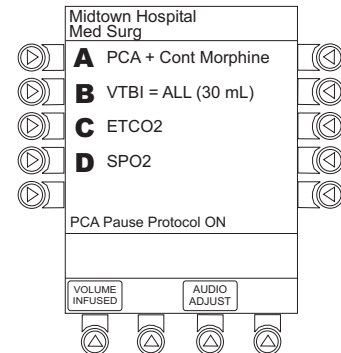

Reviewing or Changing PCA Pause Alarm Limits

1. From Main Display press **CHANNEL SELECT**.
2. Press **OPTIONS** key.
3. Press **PCA Pause Limits** soft key.

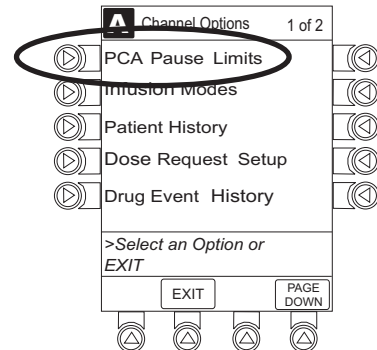

Reviewing or Changing PCA Pause Alarm Limits (Continued)

- Verify PCA pause limits as per facility protocol or physician order.

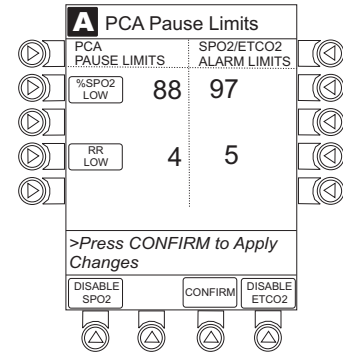

- To change PCA pause limits, press soft key that corresponds to alarm limit and enter a value within acceptable range. ^①

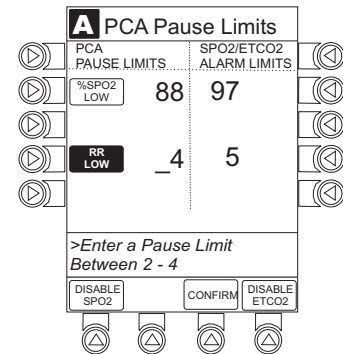

- Press **CONFIRM** soft key.
- Press **START** soft key.

NOTE:

- The acceptable range for PCA Pause Protocol is configurable and defined by the hospital within the Data Set using the Guardrails[®] Suite MX.

The **PCA PAUSE LIMITS** must be lower than the **SPO2/ETCO2 ALARM LIMITS**. A prompt is provided if the **PCA PAUSE LIMITS** must be modified.

Disabling PCA Pause Alarm

1. From Main Display press **CHANNEL SELECT**.
2. Press **OPTIONS** key.
3. Press **PCA Pause Limits** soft key.
4. Press **DISABLE SPO2** or **DISABLE ETCO2** soft key, as appropriate. ① ②

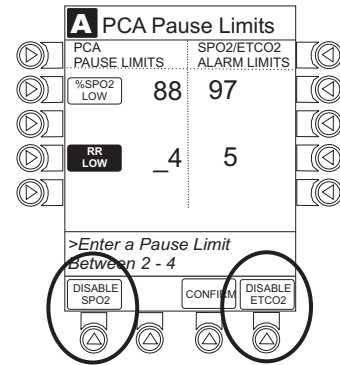

5. Press **CONFIRM** soft key.
6. Press **START** soft key.
7. To enable PCA Pause feature, follow steps 1-3 above and press **ENABLE SPO2** or **ENABLE ETCO2** soft key, as appropriate.

NOTES:

- ① Disabling SpO₂ or EtCO₂ from this screen discontinues the PCA Pause feature only, without interrupting monitoring functionality.
- ② Once disabled, the alarm limits are grayed out and are not editable.

General Setup and Operation

System Start-Up / Setup

See the PC Unit Section of this DFU, "General Setup and Operation", for various system start-up and setup procedures.

THIS PAGE
INTENTIONALLY
LEFT BLANK

Warnings and Cautions

General

WARNINGS

- The PCA Module is designed to **stop fluid flow under alarm conditions**. Periodic patient monitoring must be performed to ensure the infusion is proceeding as expected. It is a **positive displacement delivery system**, capable of developing positive fluid pressures to overcome widely varying resistances to flow encountered in practice, including resistances to flow imposed by small gauge catheters, filters and intra-arterial infusion. It is neither designed nor intended to detect infiltrations and does not alarm under infiltration conditions.
- The use of positive displacement infusion devices ported together with **gravity flow infusion** systems into a common IV site may impede the flow of common "gravity only" systems, affecting their performance. Hospital/facility personnel must ensure the performance of the common IV site is satisfactory under these circumstances.
- **Each time the Alaris® System is turned on**, verify and/or set the monitoring mode, resistance alert, and/or pressure alarm limit. If the monitoring mode, resistance alert, and/or pressure alarm limit are not verified, the instrument may not operate within the desired occlusion detection parameter(s).

Administration Sets

WARNINGS

- Use only standard, single-use, disposable syringes (with luer-lock connectors) and non-dedicated administration sets with integrated anti-siphon valves, designed for use on syringe-type PCA pumps. The use of any other **syringe or administration set** may cause improper instrument operation, resulting in an inaccurate fluid delivery or pressure sensing, or other potential hazards. For a list of compatible syringes, see "Compatible Syringes". For a list of compatible sets, reference the Set Compatibility Card (provided separately).

Warnings and Cautions (Continued)

Administration Sets (Continued)

WARNINGS

- **Before loading or unloading the syringe**, always turn off fluid flow to the patient, using the tubing clamp or stopcock. Uncontrolled fluid flow can occur when the administration set is not clamped or turned off, and may cause serious injury or death.
- When an occlusion occurs, there is a risk of infusing pressurized buildup of infusates upon correction of the occlusion. To **avoid an inadvertent bolus**, relieve the pressure before restarting the infusion.
- **When priming:**
 - ◆ Ensure patient is not connected.
 - ◆ Ensure air is expelled from line prior to beginning infusion (unexpelled air in line could have serious consequences).Failure to prime correctly can delay infusion delivery and cause the total volume to be infused to read higher than the actual total delivered to the patient.
- Ensure the syringe manufacturer and syringe size displayed matches **syringe manufacturer and syringe size installed** in the PCA Module. Mismatches may cause an under-infusion or over-infusion to the patient that could result in serious injury and/or death. For a list of compatible syringes, see "Compatible Syringes".
- **Discard if** packaging is not intact or protector caps are unattached.

CAUTION

Before operating instrument, verify that administration set is **free from kinks and installed correctly** in instrument.

Warnings and Cautions (Continued)

Epidural Administration

WARNINGS

- **Epidural administration** of drugs other than those indicated for epidural use could result in serious injury to the patient.
- It is strongly recommended that the syringe, administration set, and PCA Module used for **epidural drug delivery** be clearly differentiated from those used for other types of administration.
- The Alaris® System can be used for epidural administration of **anesthetic and analgesic drugs**. This application is only appropriate when using anesthetics and analgesics labeled for continuous epidural administration and catheters intended specifically for epidural use. Use only standard or pre-filled, single-use, disposable syringes (with luer-lock connectors) and non-dedicated administration sets with integrated anti-siphon valves, designed for use on syringe-type PCA devices without a 'Y' connector or injection port, for epidural infusions.
 - ◆ Epidural administration of **anesthetic drugs**: Use indwelling catheters specifically indicated for short-term (96 hours or less) anesthetic epidural drug delivery.
 - ◆ Epidural administration of **analgesic drugs**: Use indwelling catheters specifically indicated for either short-term or long-term analgesic epidural drug delivery.

Dose Request Cord

WARNINGS

- Only the **patient should press** the Dose Request Cord.
- **Carefully locate the Dose Request Cord** to reduce the possibility of patient entanglement or strangulation.

Warnings and Cautions (Continued)

Guardrails® Suite MX

WARNINGS

- The **Guardrails® Suite MX** incorporates dosing limits and instrument configuration parameters based on hospital/facility protocol. The software adds a **test of reasonableness** to drug programming based on the limits defined by the hospital/facility. Qualified personnel must ensure the appropriateness of drug dosing limits, drug compatibility, and instrument performance, as part of the overall infusion. **Potential hazards** include drug interactions, inaccurate delivery rates and pressure alarms, and nuisance alarms.
- When loading a **Data Set** with the Guardrails® Suite MX, **ensure the correct profile** (for patient care area) is selected prior to starting an infusion. Failure to use the appropriate profile could cause serious consequences.

Administration Set Information

The PCA Module uses standard, single-use, disposable syringes (with luer-lock connectors) and administration sets with anti-siphon valves, designed for use on syringe-type PCA pumps.

- For specific administration set instructions and set replacement interval, reference directions for use provided with set.
- For a list of compatible syringes, see "Compatible Syringes".
- For a list of compatible administration sets, reference Set Compatibility Card (provided separately).
- Use aseptic techniques when handling sets and syringes.
- Administration sets are supplied with a sterile and nonpyrogenic fluid path for one-time use. Do not resterilize.
- Discard administration set per facility protocol.
- For IV push medication (put instrument on hold), clamp tubing above port.
- Flush port(s) per facility protocol.

Compatible Syringes

The PCA Module is calibrated and labeled for use with the following single-use disposable luer-lock syringes. Use only the syringe size and type specified on the Main Display. The full list of permitted syringe models is dependent on the PCA Module's software version. ^①

Manufacturer	20 mL	30 mL	35 mL	50 mL	60 mL
B-D Plastipak	x	x		x	x
IMS Pump Jet		x ^②			
Monoject	x		x		x
Terumo	x	x		x	x

NOTES:

- ① Syringe variability may impact occlusion pressure sensing. The variability may reduce the device's time to alarm and/or may require that a higher alarm pressure limit be programmed.
- ② Prefilled Morphine Sulfate 1 mg/mL.

Features and Displays

Features and Definitions

See the PC Unit Section of this DFU for system features and definitions.

Auto Pressure Limit Adjustment	When a bolus is delivered, pressure alarm limits are temporarily raised to maximum limit.
Auto Syringe Identification	System automatically detects syringe size and narrows down syringe selection list.
Bolus Delivery Rate	Rate at which PCA, bolus and loading doses (boluses) are infused.
Bolus Dose	Allows an additional amount of medication to be programmed once PCA infusion has begun. Current PCA infusion resumes following delivery of a bolus dose.
Continuous Dose	Basal rate dose.

Features and Displays (Continued)

Features and Definitions (Continued)

Dose Request Cord	When attached, Dose Request Cord allows a patient to self-administer a PCA dose to be delivered according to programmed PCA parameters. Dose Request Cord features an indicator light which can be configured to provide feedback to patient on requested PCA doses. Dose Request Cord is enabled in PCA only and PCA + continuous modes.
Drug Event History	Records and displays sequential device events for a typical 12 hours, subject to change upon usage and number of modules.
Drug Library	When Profiles feature is enabled, it provides a hospital-defined list of drugs and concentrations appropriate for use in as many as 10 profiles. Drug Library use automates programming steps, including drug name, drug amount and diluent volume, and activates hospital-established best-practice limits. A Data Set that includes a Drug Library is required prior to using PCA Module.
Event Logging	Event Logging records instrument operations.
Initial Value	An optional and editable starting value for PCA dose, continuous dose, lockout interval or maximum limit.
Limit	<p>A programming Limit or best-practice guideline determined by hospital/health system and entered into system's Data Set. Dose Limits can be defined by hospital/health system as Hard or Soft Limits.</p> <ul style="list-style-type: none">• A Hard Limit is a programmed Limit that cannot be overridden.• A Soft Limit is a programmed Limit that can be overridden.
Loading Dose	Allows a bolus infusion to be programmed prior to initiation of PCA infusion. May be programmed from Infusion Modes menu or applicable PCA, PCA + continuous, or continuous only programming screen prior to start of a new PCA infusion program.
Lockout Interval	Allows programming of a predetermined interval of time that must elapse between delivery of PCA doses.
Max Dose Limit (Max Accumulated Dose Limit)	<p>Optional configuration that limits total amount of drug allowed to be delivered to patient in a defined period (1, 2 or 4 hours).</p> <ul style="list-style-type: none">• Should be configured in Data Set before Drug Library is developed. Once drugs are in Profile PCA Drug Library, Max Accumulated Dose Limit cannot be changed.• Applies to all drug setups within Profile PCA Drug Library.

Features and Displays (Continued)

Features and Definitions (Continued)

Module Location Enforcement	Tamper resistant security feature that ensures PCA Module is in a tamper evident position. When enabled, PCA Module must be located to direct right of PC Unit to allow programming an infusion.
Near End of Infusion (NEOI)	Allows an alert to be configured to sound anywhere between 5 – 25% volume remaining.
NEOI Alert	Alert Time can be set to occur when 5 – 25% of VTBI remains.
Occlusion Pressure	Downstream occlusion alarm threshold can be set to low, medium, or high.
Operating Modes	<p>Four operating modes are available:</p> <ul style="list-style-type: none">• PCA only• continuous infusion• PCA + continuous infusion• loading dose only <p>All programming of infusions in each of 4 modes are completed using Drug Library as defined by hospital-established best-practice.</p>
Patient History	<p>PCA Module records and displays patient history for up to 24 hours, and may be trended to following intervals: 1-hr, 2-hr, 4-hr, 8-hr, 12-hr, 24-hr. Patient history includes following trending information:</p> <ul style="list-style-type: none">• total demands• delivered demands• total drug delivered• time and date patient history last cleared• average drug per hour• total amount of drug delivered via:<ul style="list-style-type: none">➤ PCA dose➤ continuous infusion➤ loading dose➤ bolus dose
PCA Dose	Enables a patient to self-administer a bolus infusion to be delivered at programmed lockout intervals through Dose Request Cord. When programmed in PCA+continuous mode, continuous infusion resumes following PCA dose.

Features and Displays (Continued)

Features and Definitions (Continued)

PCA Pause Protocol	An optional and hospital-configurable feature intended to align with hospital/health system's current protocol for patient monitoring during PCA therapy. When enabled, PCA infusion pauses and alarms when defined monitoring values (% SpO ₂ and/or Respiratory Rate low) for SpO ₂ and/or EtCO ₂ Modules are reached.
Pressure Limit	Downstream occlusion alarm threshold can be set to low, medium or high. Syringe variability may impact occlusion pressure sensing. Variability may reduce device's time to alarm and/or may require that a higher alarm pressure limit be programmed.
Priming	Allows a limited volume of fluid to be delivered in order to prime administration set prior to being connected to a patient or after changing a syringe. When priming, a single continuous press of PRIME soft key delivers up to 2 mL of priming/fluid.
Restore	To simplify programming, can be used to recall previous PCA programming parameters for same patient. This option is only available if patient is not new and system is powered up within 8 hours of last usage.
Security Access Level	<p>Profile-specific security access level can be configured to provide varying levels of access to device. Security access is accomplished either through use of key or a 4-digit authorization code.</p> <p>For security level information, see "Programming", "Infusion Modes", "Security Access Levels".</p>
Security Code	Four-character code assigned to allow access to PC Unit for setting bolus doses and subsequent programming changes. Ability to use profile-specific code is dependent upon configured Security Access Level.
Syringe Empty	Instrument gives an alert and stops when an empty syringe is detected.
Syringe Volume Detection	System automatically detects fluid volume in a syringe when it is inserted.
Therapies	An optional hospital-defined therapy or clinical indication for delivery of that infusion. Different Limits can be defined for same medication with different therapeutic indications.
Time Window (h)	1, 2 or 4 hours.

Features and Displays (Continued)

Operating Features, Controls, Indicators

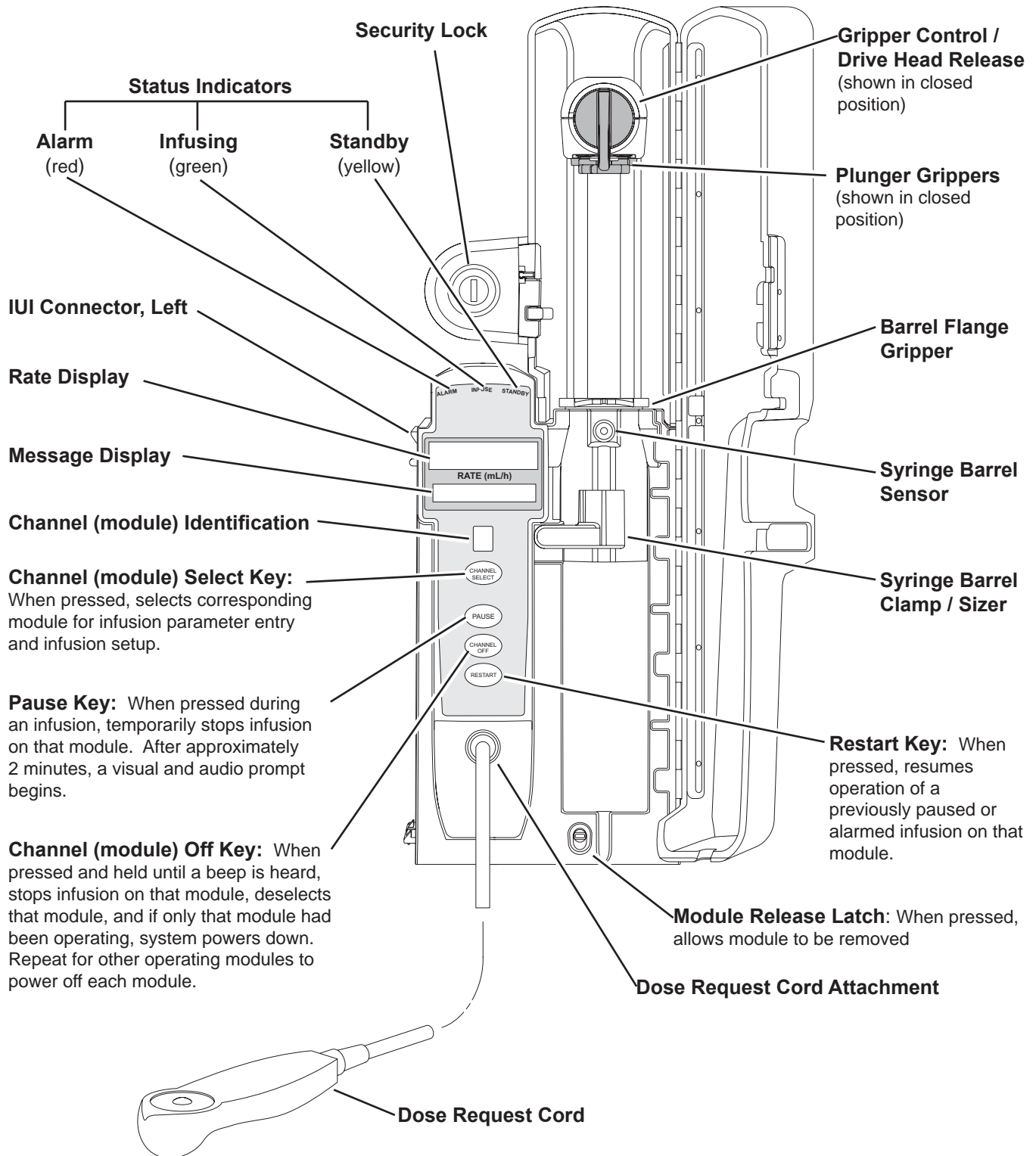

Features and Displays (Continued)

Displays

The displays illustrated throughout this document are for illustration purposes only. The display content varies, depending on configuration settings, type of administration set in use, hospital-defined Data Set uploaded using the Guardrails® Suite MX, programmed drug calculation parameters, and many other variables. Reference specific drug product labeling for information concerning appropriate administration techniques and dosages.

Configurable Settings

See the PC Unit Section of this DFU for system configurable settings.

The configuration settings are selected during Data Set development and then uploaded to the Alaris® System as part of the data.

With the Profiles feature enabled, the settings are configured independently for each profile. A hospital-defined, best-practice Data Set must be uploaded to enable the Profiles feature. Date and Time is a system setting and is the same in all profiles.

Feature	Default Setting	Options
Authorization Code	None	4 digits (0 - 9) One code applies to all profiles
Bolus Delivery Rate	150 mL/h	75 - 500 mL/h (limited by syringe size)
Bolus Dose	Enabled	Enabled - Disabled
Bolus Dose include in Max. Limit	Disabled	Enabled - Disabled
Dose Request Cord Configuration	Profile 2	Profile 1, 2, 3
Loading Dose	Enabled	Enabled - Disabled
Lockout Interval	1 - 99 minutes in 1-minute increments	Min/Max 1 - 99 minutes
Max Accumulated Dose Range	1-hour limit	Disabled; 1, 2 or 4-hour limit
Max Rate (for Continuous Dose) ^①	999 mL/h	0.1 - 99.9 mL/h in 0.1 mL/h increments; 100 - 999 mL/h in 1 mL/h increments

Configurable Settings (Continued)

Feature	Default Setting	Options
NEOI	Disabled	Enabled - Disabled
• Alert Time		5 - 25% of remaining infusion
Occlusion Pressure Set Point	High (800 mmHg)	Low (200 mmHg) Medium (500 mmHg) High (800 mmHg)
PCA Pause Protocol:		
• PCA Pause Protocol	Disabled	Enabled - Disabled
• Monitoring Module Attach Enforcement	None	Enabled - Disabled
• PCA Pause Protocol Text	PCA infusion has paused due to a decline in respiratory status. Check patient.	Editable per hospital protocol
• SpO ₂ Settings ^②		
♦ % SpO ₂ Low Limit	None	20 - 99
♦ Initial Value	None	20 - 99
• EtCO ₂ Settings ^③		
♦ Respiratory Rate Lower Limit (bpm)	None	0 - 149
♦ Initial Value	None	0 - 149
Priming	Disabled	Enabled - Disabled
Forced Module Location	Enabled	Enabled - Disabled
Security Access Level	Level 1	Level 1, 2, 3

NOTES:

- ① This configuration setting is a shared setting between the PCA Module and the Syringe Module.
- ② These values are configured in the SpO₂ Module settings within the Editor Software and can be changed by the clinician by accessing Channel Options on the PCA Module.
- ③ These values are configured in the EtCO₂ Module settings within the Editor Software and can be changed by the clinician by accessing Channel Options on the PCA Module.

Specifications and Symbols

Specifications

Bolus Dose Range	Configured according to hospital best-practice guidelines.	
Bolus Volume, Maximum after Occlusion:	<u>Occlusion Pressure Limit</u>	<u>Bolus Volume (mL)</u>
	High	0.994
	Low	0.396
	Maximum Bolus Volume specifications are based on following standard operating conditions:	
	Atmospheric Pressure:	645 - 795 mmHg
	Disposable Type:	#30883
	Humidity:	20 - 90%
	Rate:	5 mL/h
	Syringe Type:	BD 50/60 mL
	Temperature:	68 ±4° F
	Volume Collection Time:	approximately 2 minutes
Critical Volume:	Maximum over-infusion which can occur in event of a single-fault condition will not exceed 2% of nominal syringe fill volume during loading and 1% of maximum syringe travel after syringe loading.	
Delivery Units	mcg, mcg/h, mg, mg/h, mL, mL/h	
Dimensions:	4.5" W x 15.0" H x 7.5" D (exclusive of security door)	
Environmental Conditions:	<u>Operating</u>	<u>Storage/Transport</u>
Temperature Range:	41 - 104° F (5 - 40° C)	-4 -140° F (-20 - 60° C)
Relative Humidity: (Avoid prolonged exposure to relative humidity >85%)	20 - 90% Noncondensing	5 - 85% Noncondensing
Atmospheric Pressure:	525 - 4560 mmHg (700 - 6080 hPa)	375 - 760 mmHg (500 - 1013 hPa)
Equipment Orientation:	To ensure proper operation, Alaris® System must remain in an upright position.	

Specifications and Symbols (Continued)

Specifications (Continued)

Flow Rate Programming: The flow rate range is from 0.1 to 999 mL/h as follows:

<u>Flow Rates (mL)</u>	<u>Selectable Increments (mL/h)</u>
0.10 - 9.99	0.01
10 - 99.9	0.1
100 - 999	1.0

Rate Restriction by Syringe Size:	<u>Syringe Size (mL)</u>	<u>Flow Rate Range (mL/h)</u>
	50/60	0.1 - 999
	30/35	0.1 - 650
	20	0.1 - 500

Fluid Ingress Protection: IPX1, Drip Proof

Loading Dose Range: Configured according to hospital best-practice guidelines.

Max Limit Range: Configured according to hospital best-practice guidelines.

Occlusion Alarm Thresholds: Three settings:

Low
Medium
High

Operating Principle: Positive displacement

PCA Dose Range: Configured according to hospital best-practice guidelines.

Rate Accuracy: $\pm 2\%$ of full-scale plunger travel (not including syringe variation)

WARNING

Syringe size and running force, variations of back pressure, or any combination of these **may affect rate accuracy**. Factors that **can influence back pressure** are: administration set configuration, IV solution viscosity, and IV solution temperature. Back pressure may also be affected by type of catheter. See "Trumpet and Start-Up Curves" for data on how these factors influence rate accuracy.

Shock Protection: Type CF, Defibrillator Proof (PCA Module)
Type BF, Defibrillator Proof (Dose Request Cord)

Specifications and Symbols (Continued)

Specifications (Continued)

Time to Alarm, Maximum:	<u>Rate (mL/h)</u>	<u>High</u>	<u>Low</u>
	1	120 minutes	37 minutes
	5	30 minutes	7 minutes

Maximum Time to Alarm specifications are based on following standard operating conditions:

Atmospheric Pressure:	645 - 795 mmHg
Back Pressure:	0 mmHg before producing occlusion
Disposable Type:	#30883
Humidity:	20 - 90%
Syringe Type:	BD 50/60 mL
Temperature:	68 ±4° F

Weight: 5.5 lbs

Symbols

See the PC Unit Section of this DFU for system symbols.



Type CF, defibrillation-proof (PCA Module)



Type BF, defibrillation-proof (Dose Request Cord)



Manufacturer.

Single-Use



Single-Use. Do not re-use.



DEHP in fluid pathway.



No DEHP in fluid pathway.



Product is latex-free.



Approximate administration set priming volume.



Expiration date for product is identified near hour glass symbol.

Specifications and Symbols (Continued)

Symbols (Continued)



Do not use if package is damaged.



Product contains micron filter, where xx represents filter size.



Authorized representative in European Community.

Trumpet and Start-Up Curves

In this instrument, as with all infusion systems, the action of the pumping mechanism and variations in individual syringes and administration sets cause short-term fluctuations in rate accuracy. The following graphs show typical performance of the system, as follows:

- Accuracy during various time periods over which fluid delivery is measured (trumpet curves).
- Delay in onset of fluid flow when infusion commences (start-up curves).

Trumpet and start-up curves have been provided for 0.1 mL/h, 1.0 mL/h and 5.0 mL/h. Measurements for trumpet curve rates above 5.0 mL/h are also not provided, as the syringe volume is displaced in a very short time with a rate up to 999 mL/h. Accuracy, however, is assured with the design implementation.

Trumpet curves are named for their characteristic shape. They display discrete accuracy data averaged over particular time periods or "observation windows", not continuous data versus operating time.

Over long observation windows, short-term fluctuations have little effect on accuracy, as represented by the flat part of the curve. As the observation window is reduced, short-term fluctuations have greater effect, as represented

by the "mouth" of the trumpet. Knowledge of system accuracy over various observation windows may be of interest when certain drugs are being administered.

Because the clinical impact of short-term fluctuations on rate accuracy depends on the half-life of the drug being infused and on the degree of intravascular integration, the clinical effect cannot be determined from the trumpet curves alone. Knowledge of the start-up characteristics should also be considered.

The start-up curves represent continuous flow rate versus operating time for two hours from the start of the infusion. They exhibit the delay in onset of delivery due to mechanical compliance and provide a visual representation of uniformity. Trumpet curves are derived from the second hour of this data.

Under conditions of -100 mmHg, +100 mmHg, and +300 mmHg pressures, the PCA Module typically exhibits a long-term accuracy offset of approximately 0.2% or less from the mean value.

Trumpet and Start-Up Curves (Continued)

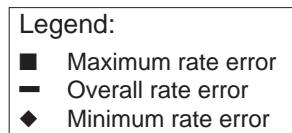
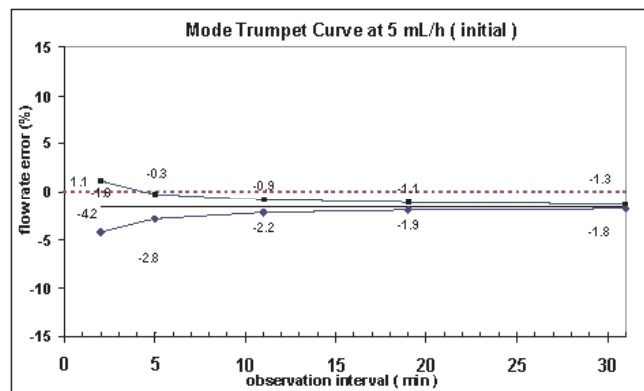
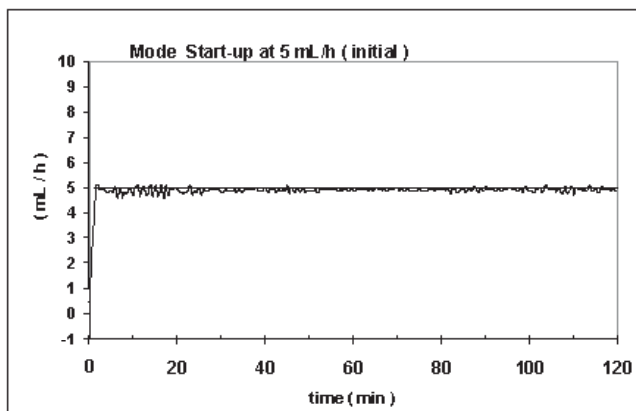
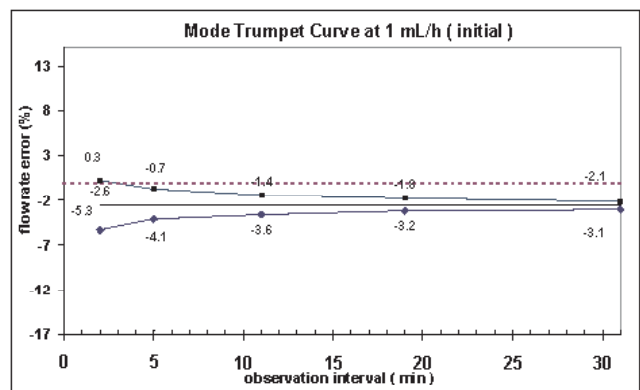
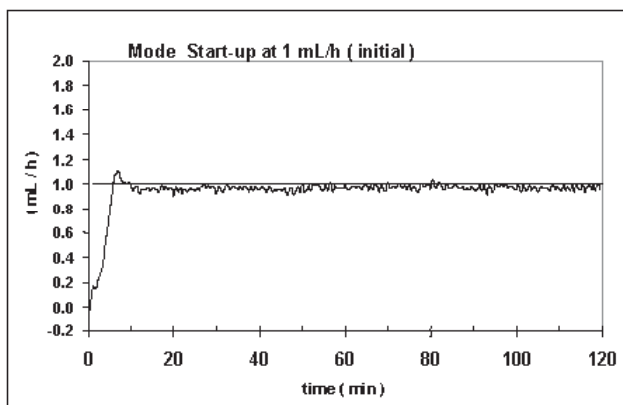
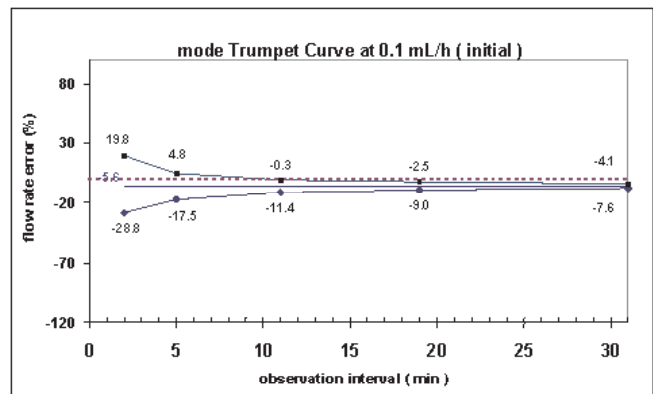
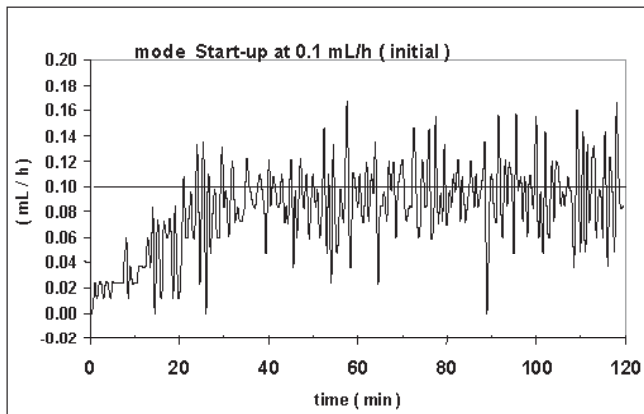

Troubleshooting and Maintenance

General

The PCA Module Technical Service Manual is available from Cardinal Health. It includes routine service schedules, interconnect diagrams, component parts lists and descriptions, test procedures, and other technical information, to assist qualified service personnel in repair and maintenance of the instrument's repairable components. Maintenance procedures are intended to be performed only by qualified personnel, using the Service Manual and System Maintenance software.

Artifacts: It is normal for an infusion device to produce nonhazardous currents when infusing electrolytes. These currents vary proportional to the infusion device flow rate. When an ECG monitoring system is not functioning under optimal conditions, these currents may appear as artifacts, simulating actual ECG readings. To determine if ECG abnormalities are caused by patient condition or the ECG equipment, place the infusion device on hold. If the ECG readings become normal, the ECG equipment requires attention. Proper setup of the ECG equipment should eliminate these artifacts. Reference the appropriate ECG monitoring system documentation for instructions on setup and maintenance.

Alarms, Errors, Messages

See the PC Unit Section of this DFU for the following system references:

- Alarms, Errors, Messages
- Audio Characteristics
- Definitions
- Radio Frequency Note

Alarms, Errors, Messages (Continued)

Definitions

Alert	A visual message to help reduce programming errors by indicating a Limit (Soft or Hard) has been exceeded. A response is required before programming can continue.
Clinical Advisory	A visual message when a designated drug is selected, to remind clinician of specific hospital/facility standards of practice when programming an IV medication. A specific Clinical Advisory and/or message can be associated with a selected drug within any of the patient care profiles. Clinical Advisories are not displayed in Anesthesia mode.

Alarms

Alarm	Meaning	Response
Attach Dose Request Cord	Dose Request Cord detached from device. Dose Request Cord required for PCA only and PCA + continuous infusion modes.	Reattach Dose Request Cord and press RESTART key.
Channel Disconnected	Module(s) disconnected while in operation or have a communication problem.	To silence alarm and clear message from screen, press CONFIRM soft key. Reattach module, if desired, ensuring it is securely "clicked" into place at Channel Release Latch. If alarm is still present, replace module with an operational instrument.
Lock Door	Door unlocked during infusion (system does not infuse with door unlocked).	Lock door and press RESTART key.
Occlusion	Increased back pressure sensed while infusing. Infusion stops on affected module.	Clear occlusion. Press RESTART key, or press CHANNEL SELECT key and then START soft key.
PCA Pause Alarm	PCA infusion has paused due to a decline in respiratory status.	Assess patient status per hospital policy. Press CONFIRM once patient status and monitoring values have been addressed. Press RESTART key per hospital policy.

Alarms, Errors, Messages (Continued)

Alarms (Continued)

Alarm	Meaning	Response
Syringe Empty	<p>Syringe is empty.</p> <p>If syringe is not empty, other possibility is: Syringe plunger travel impeded.</p>	<ul style="list-style-type: none"> ➤ Set up new infusion or press CHANNEL OFF key. ➤ Verify syringe plunger movement is unimpeded. <p>If syringe is not empty and above actions do not correct alarm, replace module with an operational instrument.</p>

Syringe Adjustment Alarms

When a syringe installation problem is detected, a visual signal is displayed. Text in the display blinks to indicate the location of the problem.

- When problem is corrected, press **CONFIRM** soft key.

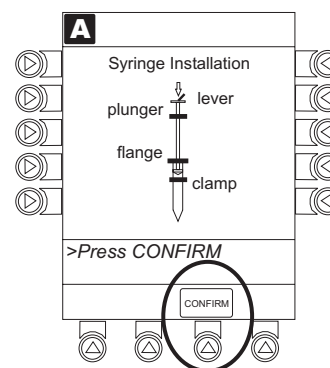

Alarm	Meaning	Response
Check Syringe	<p>Plunger grippers opened during infusion and then closed. Infusion stops on affected module.</p> <p>Syringe barrel clamp opened during infusion and then closed. Infusion stops on affected module.</p> <p>Syringe plunger not captured while in idle state. System alarms after 30 seconds, to indicate potential siphoning condition.</p>	<ul style="list-style-type: none"> ➤ Securely lock plunger grippers, press CHANNEL SELECT key, and reselect syringe. ➤ Securely lock syringe barrel clamp and press RESTART key. ➤ Check for potential siphoning. Ensure administration set clamp (roller/slide) is in closed position. Securely lock plunger grippers over syringe plunger.
Drive Not Engaged	Drive system disengaged during operation.	Open and close plunger grippers and syringe barrel clamp. Ensure syringe is properly installed.

Alarms, Errors, Messages (Continued)

Errors

Error	Meaning	Response
Channel Error	Error detected. Operation stops on affected module.	To silence alarm and continue operation of unaffected modules, press CONFIRM soft key. Replace module with an operational instrument, as needed.
Syringe Calibration Required	Error on infusing module indicating calibration is required. Infusion stops on affected module. CALIBRATE scrolls in Message Display.	To silence alarm and continue operation of unaffected modules, press CONFIRM soft key. Replace module with an operational instrument, as needed.
Syringe Driver Head Error	Noninfusing module, with plunger grippers open, senses excessive pressure being applied downward on Drive Head. OCCCLUSION scrolls in Message Display.	To silence alarm and continue normal operation, press CONFIRM soft key.

Messages

Message	Meaning	Response
Bolus Complete	Current bolus dose completed. Channel running in continuous dose if programmed.	None
Infusion Complete	Current infusion completed.	Set up a new infusion or press CHANNEL OFF key.
Load Complete	Current loading dose completed. Infusion mode menu available or programmed infusion running.	None
Max Limit Reached	Programmed maximum limit has been reached over time period specified. Infusion paused until time limit has expired.	To silence alarm, press SILENCE key. To change Max Limit , press CHANNEL SELECT , press PROGRAM soft key, and unlock door or enter Authorization Code applicable for current Security Access Level.

Alarms, Errors, Messages (Continued)

Messages (Continued)

Message	Meaning	Response
NEOI (Near End of Infusion)	Syringe almost empty.	<p>This is a timed event that can be set or changed (see "General Information", "Configurable Settings").</p> <p>To silence alarm, press SILENCE key. PCA Module remains functional and continues infusion. Green indicator light is lit and yellow light flashes. PCA Module is silent until Syringe Empty alarm sounds (see Syringe Empty alarm response).</p>
Panel Locked	Tamper Resist feature is active and a key was pressed.	If appropriate, deactivate Tamper Resist feature using Tamper Resist Control on back of PC Unit.
Panel Unlocked	Tamper Resist feature deactivated.	None.
Pause	Pause control pressed; infusion stopped.	To resume infusion, press RESTART key, or press CHANNEL SELECT key and then START soft key.
PCA Complete	Current PCA dose complete. Channel running in continuous dose if programmed.	None.
PCA Not In Secure Location	PCA Module is not in preferable location to allow locking to PC Unit. Device is not in a tamper evident position.	Detach PCA Module from current position and reattach to immediate right of PC Unit.
Syringe Not Recognized	Installed syringe of unknown type and size.	Select and confirm correct syringe type and size, and then press CONFIRM , or use a syringe type and size that system can automatically and correctly identify.

Inspection Requirements

To ensure the Alaris® System remains in good operating condition, both regular and preventive maintenance inspections are required. Reference the System Maintenance software for detailed instructions.

REGULAR INSPECTIONS

PROCEDURE	FREQUENCY
INSPECT FOR DAMAGE:	
Exterior Surfaces	Each usage
Keypad	Each usage
Seal	Each usage
Mechanical Parts	Each usage
CLEANING	As required
START-UP	Each usage

WARNING

Failure to perform these inspections may result in improper instrument operation.

CAUTION

Regular and preventive maintenance inspections should only be performed by qualified service personnel.

Alaris® SpO₂ Modules Models 8210 and 8220

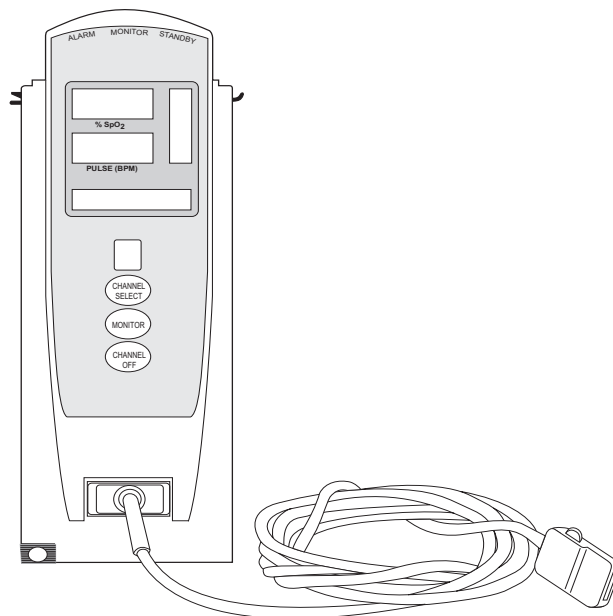

GETTING STARTED

INTRODUCTION.....	4-1
ATTACHING CABLE AND SENSOR.....	4-2

PROGRAMMING

MONITORING MODE.....	4-3
Setting Alarm Limits.....	4-4
Navigating Trend Data.....	4-5
Navigating PCA/SpO ₂ Trend Data.....	4-7
Presilencing Alarm.....	4-8
CHANNEL OPTIONS.....	4-8
Changing Limit Mode.....	4-8
Changing Pulse Beep Volume.....	4-9
Changing SatSeconds Limit (Model 8210).....	4-10
Changing Saturation Averaging Time (Model 8220).....	4-10
Changing Sensitivity Mode (Model 8220).....	4-11

GENERAL SETUP AND OPERATION

SYSTEM START-UP / SETUP.....	4-13
------------------------------	------

GENERAL INFORMATION

WARNINGS AND CAUTIONS.....	4-15
General.....	4-15
Sensors and Cables.....	4-16
CABLES AND SENSORS.....	4-17
Nelcor® Patient Cables and OxiMAX Sensors.....	4-17
Masimo® Patient Cables and Sensors.....	4-17
FEATURES AND DISPLAYS.....	4-18
Features and Definitions.....	4-18
Operating Features, Controls, Indicators.....	4-21
Displays.....	4-22
CONFIGURABLE SETTINGS.....	4-23
Models 8210 and 8220.....	4-23
Model 8210.....	4-23
Model 8220.....	4-24
SPECIFICATIONS AND SYMBOLS.....	4-24
Specifications.....	4-24
Symbols.....	4-27
MEASUREMENT ACCURACY.....	4-27

TROUBLESHOOTING AND MAINTENANCE

GENERAL.....	4-29
ALARMS AND MESSAGES.....	4-29
Alarms.....	4-29
Messages.....	4-31
INSPECTION REQUIREMENTS.....	4-32

THIS PAGE
INTENTIONALLY
LEFT BLANK

Introduction

This Section of the DFU provides SpO₂ Module (Models 8210 and 8220) instructions and information. It is used in conjunction with:

- Nellcor® and Masimo® cable and sensor instructions
- PC Unit Section of this DFU
- SpO₂ Module sensor and cable Compatibility Cards
- SpO₂ Module Technical Service Manual
- System Maintenance software (and its instructions) for Alaris® System check-in, maintenance, and wireless configuration

The SpO₂ Modules are indicated for continuous, noninvasive monitoring of functional oxygen saturation of arterial hemoglobin (SpO₂) and pulse rate measured by an SpO₂ sensor. The SpO₂ Modules and accessories are indicated for use with adult, pediatric and neonatal patients, and for patients who are well or poorly perfused in hospitals and hospital-type facilities. The Model 8220 SpO₂ Module is also indicated for use during motion and no motion conditions. Only one (1) SpO₂ Module can be connected to the Alaris® System.

The majority of user interface programming is identical for both SpO₂ Modules. If a procedure/information applies to a specific module, the following identifiers indicate the applicable model.

Model 8210:  **NELLCOR**
(8210)

Model 8220:  **MASIMO SET.**
(8220)

Cables and Sensors: See "General Information" for "Cables and Sensors" information.

Alarms and Messages: See "Troubleshooting and Maintenance" for module-specific "Alarms and Messages".

Contraindications: The SpO₂ Modules are contraindicated for use as apnea monitors.

Electromagnetic Environment: See "Appendix" Section of this DFU ("Regulations and Standards", "Compliance").

WARNING

Read all instructions, for the SpO₂ Modules and PC Unit, before using the Alaris® System.

CAUTION

Rx Only

Attaching Cable and Sensor

WARNING

Model 8210:

Use only approved OxiMAX sensors, and DOC-10 and OC-3 pulse oximetry cables.

Model 8220:

Use only approved Masimo® sensors and patient cables.

Use of sensors, transducers, cables and accessories other than those specified may cause improper SpO₂ Module performance resulting in inaccurate readings, increased emission and/or decreased immunity, and degraded electromagnetic compatibility performance of the SpO₂ Module. For a list of compatible sensors and cables, reference the Sensor and Cable Compatibility Card (provided separately).

1. Attach applicable patient cable to SpO₂ Module. Ensure secure connection and patient cable is not twisted, sliced or frayed.
2. Attach applicable sensor to patient cable. Reference sensor's directions for use for detailed instructions.

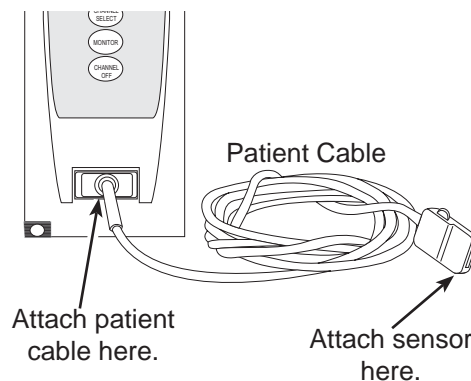

3. Attach sensor to patient. Reference sensor's directions for use for detailed instructions.

Display references throughout this procedure are for illustration purposes only.

See "General Information", "Features and Displays" and the PC Unit Section of this DFU for information about:

- Displays
- Operating Features, Controls, Indicators

The majority of user interface programming is identical for both SpO₂ Modules.

Monitoring Mode

1. Perform following steps (see PC Unit Section of this DFU, "General Setup and Operation", "Start-Up"):
 - a. Power on system.
 - b. Choose **Yes** or **No** to **New Patient?**
 - c. Confirm current profile or select a new profile.
 - d. Enter patient identifier, if required.
2. Attach patient cable and sensor (see "Getting Started").
3. Press **CHANNEL SELECT** key.
 - **SEARCHING** may appear in Channel Message display until SpO₂ and pulse readings stabilize (approximately 15 seconds).
 - If sensor is not attached to a site, **SENSOR OFF** displays.
 - To prevent screen from reverting to Main Display, press **ENTER** key within 30 seconds after **SPO2 Main** screen displays.
 - If sensor is not attached during message display, module goes into sleep mode. To begin monitoring once module is in this mode, press **MONITOR** key.
4. Ensure sensor's red LED is on.

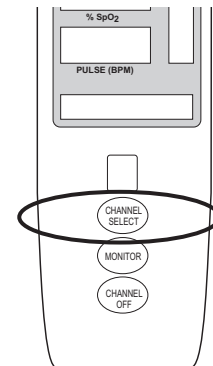

Monitoring Mode (Continued)

- To change alarm limits, see "Setting Alarm Limits" procedure.

OR

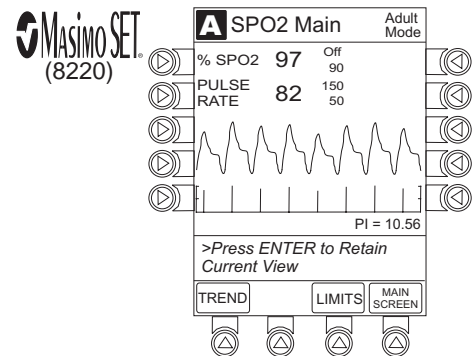
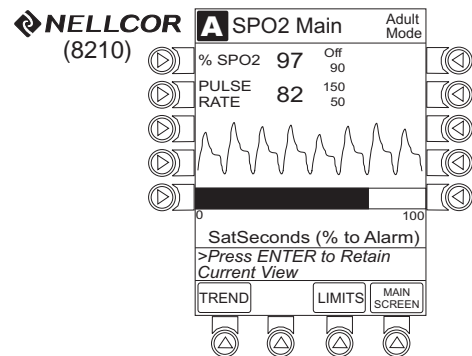

To accept settings and begin monitoring, press **ENTER** key.

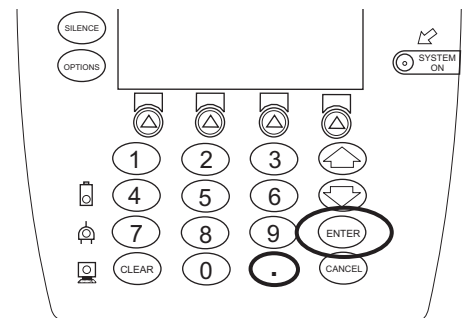

Setting Alarm Limits

- Press **LIMITS** soft key.

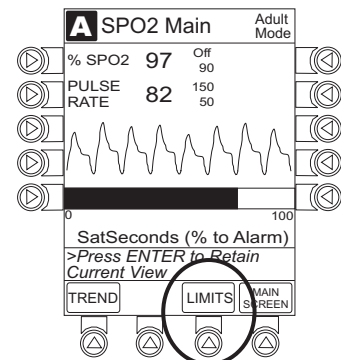

Monitoring Mode (Continued)

Setting Alarm Limits (Continued)

- To change a limit setting, press soft key next to applicable parameter.

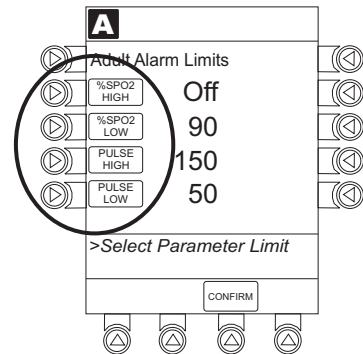

- Enter a numeric value for selected alarm limit.
 - %SPO2 HIGH** limit can be **Off** or a numeric value.
- To move to next limit, press **ENTER** key.
- To confirm alarm settings and return to **SPO2 Main** display, press **CONFIRM** soft key.
- To return to Main Display, press **MAIN SCREEN** soft key.

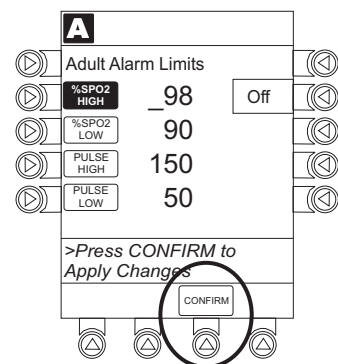

Navigating Trend Data

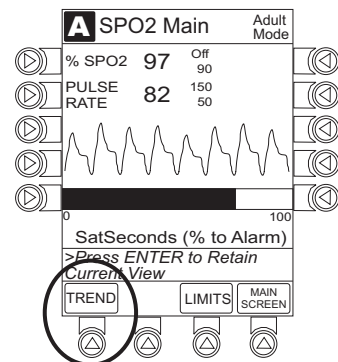

- To view **Trend Data**, press **TREND** soft key. ① ② ③



- To navigate from page to page, press **PAGE UP** and **PAGE DOWN** soft keys.

Monitoring Mode (Continued)

Navigating Trend Data (Continued)

3. To scroll data 1 row at a time, press  or  key.

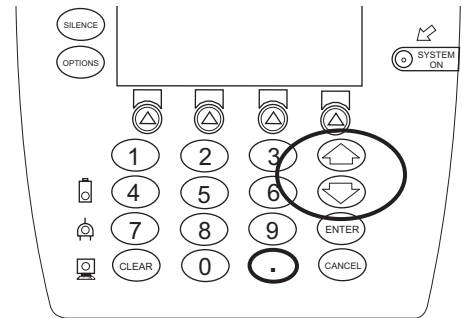

4. To change **TIME** increments for data review, move cursor to desired time period and press **ZOOM** soft key.
- New time increments display.
 - Each press of **ZOOM** soft key changes time increments.

Trend Data				09:00	
Adult Mode					
2001-07-06	SPO2	PULSE			
TIME	AVG	MAX	AVG	MAX	
	MIN	MIN	MIN	MIN	
07:01	97	100	82	150	
05:01	97	100	82	150	
03:01	97	100	82	150	
01:01	---	---	---	---	
23:01	97	100	82	150	
21:01	97	100	82	150	
		88		50	

ZOOM: 120 60 30 5 1 minutes

>Press UP/DOWN Keys to Move Cursor.

PAGE UP ZOOM SPO2 MAIN PAGE DOWN

The ZOOM soft key is circled in red.

5. To return to **SPO2 Main** display, press **SPO2 MAIN** soft key.
6. To return to Main Display, press **MAIN SCREEN** soft key.

NOTES:

- ① Tabular information is not updated while the **Trend Data** view is displayed. The tabular data is updated, using the new trend data stored in the SpO₂ Module, after leaving the **Trend Data** view. To view the latest data, return to the **Trend Data** view.
- ②  displays if an alarm limit is reached.
- ③ If no **SPO2** or **PULSE** rate values are available for the time period displayed, dashes (---) are displayed.

Monitoring Mode (Continued)

Navigating PCA / SpO₂ Trend Data

To access and view shared trend data when a PCA Module is present, perform the following steps:

1. To access option to view trend data, press **OPTIONS** key while in **SPO2 Main** display.
2. To view **Trend Data**, press **PCA/SpO₂ Trend data** soft key. ① ② ③

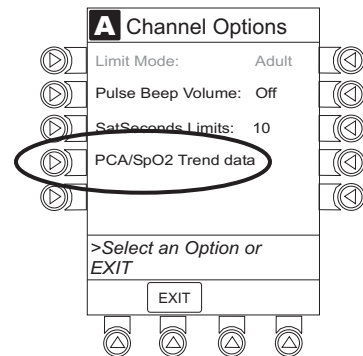

3. See "Navigating Trend Data" procedure for instructions on how to:
 - Navigate from page to page.
 - Change **TIME** increments.
 - Return to **SPO2 Main** display.
 - Return to Main Display.

A Morphine 1mg/mL 09:00

2003-06-06 TIME	TOTAL DOSE (mg)	SPO2 AVG	PULSE AVG
08:00	---	97	82 [▲]
08:01	2.55	97	82
08:02	1.2	97	82
08:03	5.01	97 [▲]	82
08:04	---	---	---
08:05	2	97	82

ZOOM: 120 60 30 5 **1** minutes

>Press UP/DOWN Keys to Move Cursor.

ZOOM SPO2 MAIN PAGE DOWN

NOTES:

- ① Tabular information is not updated while the **Trend Data** view is displayed. The tabular data is updated, using the new trend data stored in the SpO₂ Module, after leaving the **Trend Data** view. To view the latest data, return to the **Trend Data** view.
- ② [▲] displays if an alarm limit is reached.
- ③ If no **SPO2** or **PULSE** rate values are available for the time period displayed, dashes (---) are displayed.

Monitoring Mode (Continued)

Presilencing Alarm

1. To presilence alarm, press **SILENCE** key.
 - All monitoring alarms are silenced for 120 seconds. Subsequent infusion alarms are not silenced.

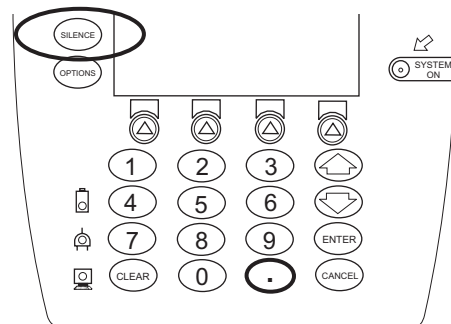

2. To cancel presilence alarm and return to alarmable mode:
 - Press **CHANNEL SELECT** key.
 - Press **CANCEL SILENCE** soft key.

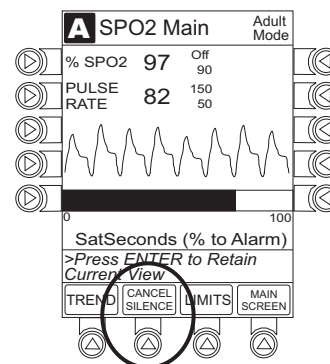

Channel Options

Changing Limit Mode

The following procedure can be performed only when the Guardrails® Suite MX is not enabled (profile option not being used for programming).

1. Press **Limit Mode** soft key.

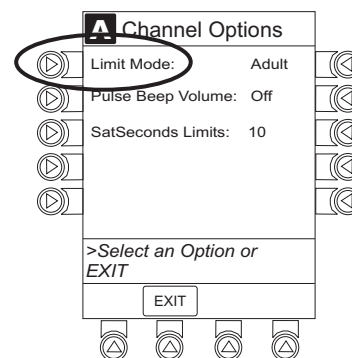

Channel Options (Continued)

Changing Limit Mode (Continued)

- To change **Limit Mode Setup**, press applicable soft key.

OR

To leave **Limit Mode Setup** unchanged and return to **SPO2 Main** display, press **EXIT** soft key.

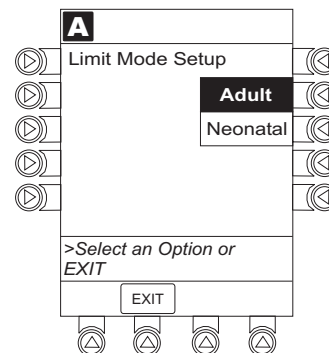

Changing Pulse Beep Volume

- Press **Pulse Beep Volume** soft key.

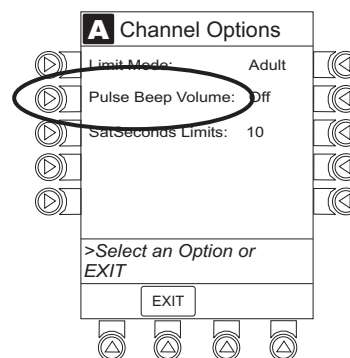

- To test or change:
 - To test volume level (when not attached to patient), press **Test** soft key. ^①
 - To increase volume, press **Louder** soft key until desired volume level is attained (1, 2 or 3).
 - To decrease volume, press **Softer** soft key until desired volume level is attained.
 - To turn off pulse beep, press **Off** soft key.
- To return to **SPO2 Main** display, press **CONFIRM** soft key.

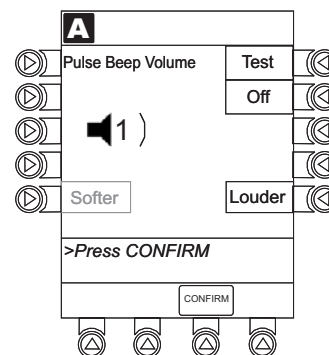

NOTE:

- ^① The pulse beep must be on to test the volume level. To turn pulse beep on, press the **Louder** soft key and adjust as needed (steps 2b and 2c).

Channel Options (Continued)

Changing SatSeconds Limit



NELLCOR
(8210)

1. Press **SatSeconds Limits** soft key.

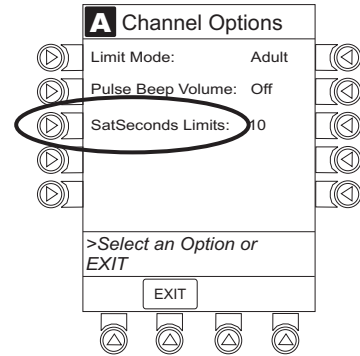

2. To change **SatSeconds**, press applicable soft key. Selectable **Increase** and **Decrease** options are **10, 25, 50** and **100** seconds.
3. To return **SPO2 Main** display, press **CONFIRM** soft key.

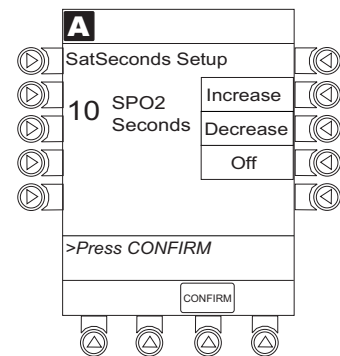

Changing Saturation Averaging Time



MASIMO SET.
(8220)

1. Press **Saturation Averaging Time** soft key.

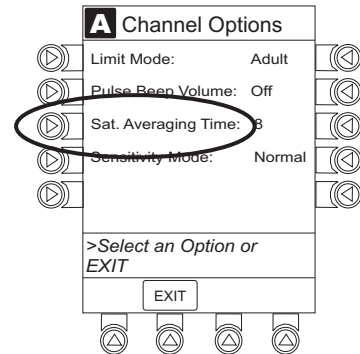

Channel Options (Continued)

Changing Saturation Averaging Time (Continued) →

Masimo SET
(8220)

- To change **Saturation Averaging Time**, press applicable soft key. Selectable options are **2**, **4**, **8**, **10**, **12**, **14** and **16** seconds.
 - FAST SAT** is enabled when **2** or **4** seconds is selected.
- To return **SPO2 Main** display, press **CONFIRM** soft key.

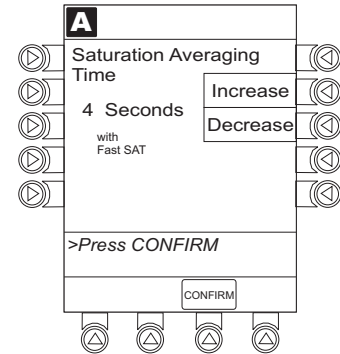

Changing Sensitivity Mode →

Masimo SET
(8220)

- Press **Sensitivity Mode** soft key.
- To change **Sensitivity Mode**, press applicable soft key. ^①
 - Normal**: Normal patient monitoring.
 - Maximum**: Improved low perfusion performance.

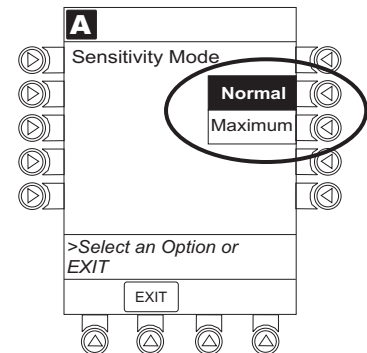
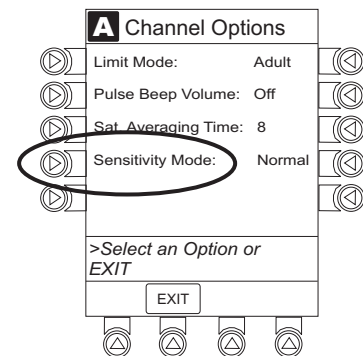

NOTE:

- ^① The sensitivity mode displays on the **SPO2 Main** display only when **Maximum** is selected.

THIS PAGE
INTENTIONALLY
LEFT BLANK

General Setup and Operation

System Start-Up / Setup

See the PC Unit Section of this DFU, "General Setup and Operation", for various system start-up and setup procedures.

THIS PAGE
INTENTIONALLY
LEFT BLANK

Warnings and Cautions

General

WARNINGS

- The SpO₂ Module is **not to be used as an apnea monitor**.
- **Pulse oximetry readings and pulse signal** can be affected by certain ambient conditions, sensor application errors and certain patient conditions.
- The SpO₂ Module is intended only as an **adjunct in patient assessment**. It must be used in conjunction with clinical signs and symptoms.
- The SpO₂ Module should be considered an **early warning device**. As a trend towards patient deoxygenation is indicated, blood samples should be analyzed by a laboratory CO-Oximeter to completely understand the patient's condition.
- **Interfering Substances:** Carboxyhemoglobin and methemoglobin may erroneously increase readings. The level of increase is approximately equal to the amount of carboxyhemoglobin present. Dyes, or any substance containing dyes, that change usual arterial pigmentation may cause erroneous readings.
- The SpO₂ Module is **not rated for defibrillation use**. Disconnect the sensor from the patient or patient cable from the module prior to defibrillation.
- **Do not lift** the SpO₂ Module by the cable because it may disconnect from the instrument, causing it to drop on the patient. Do not place the SpO₂ Module in any position that may cause it to fall onto the patient.
- **Respond immediately to system alarms;** patient monitoring may cease under certain alarm conditions.

Warnings and Cautions (Continued)

Sensors and Cables

WARNINGS

- **Inspect the SpO₂ sensor site regularly** to ensure correct sensor positioning, application and site integrity. Tissue damage could occur over prolonged time periods, depending on the patient profile (such as neonates) and method of application. Reference the sensor instructions for additional information.
- Do not use a sensor, cable or connector that **appears damaged**. Do not use a sensor with **exposed optical components**.
- The sensor **disconnect error message** and associated alarm indicate the sensor is either disconnected or the wiring is faulty. Check the sensor connection and, if necessary, replace the sensor.
- **Model 8210:**
 - **Use only approved OxiMAX sensors, and DOC-10 and OC-3 pulse oximetry cables.**
- **Model 8220:**
 - **Use only approved Masimo® sensors and patient cables.**
 - Use of sensors, transducers, cables and accessories other than those specified may cause improper SpO₂ Module performance resulting in inaccurate readings, increased emission and/or decreased immunity, and degraded electromagnetic compatibility performance of the SpO₂ Module. For a list of compatible sensors and cables, reference the Sensor and Cable Compatibility Card (provided separately).
- **Carefully route patient cabling** to reduce the possibility of patient entanglement or strangulation.
- Before use, **read the sensor directions for use**, including all warnings, cautions and instructions.

CAUTION

Do not immerse or dampen the sensor or cable. Clean per manufacturer's instructions.

Cables and Sensors

Nellcor® Patient Cables and OxiMAX Sensors



The Nellcor® DOC-10 and OC-3 patient cables interface the SpO₂ Module with the patient sensors.

When selecting a sensor, consider the patient's weight, the adequacy of perfusion, the available sensor sites and the duration of monitoring. Use only OxiMAX sensors. Select an appropriate sensor, apply it as directed, and observe all warnings and cautions presented in the directions for use accompanying the sensor.

For a list of compatible sensors and cables, reference the Sensor and Cable Compatibility Card (provided separately).

Masimo® Patient Cables and Sensors



Reusable patient cables of various lengths are available. All cables that display the Masimo® SET® logo are designed to work with an SpO₂ Module displaying the Masimo® SET® logo.

When selecting a sensor, consider the patient's weight, the adequacy of perfusion, the available sensor sites and the duration of monitoring. Use only Masimo® SET® sensors. Select an appropriate sensor, apply it as directed, and observe all warnings and cautions presented in the directions for use accompanying the sensor.

For a list of compatible sensors and cables, reference the Sensor and Cable Compatibility Card (provided separately).

Features and Displays

Features and Definitions

See the PC Unit Section of this DFU for system features and definitions.

Models 8210 and 8220

% SpO₂ Alarm Limits	Upper and lower saturation limits for %SpO ₂ alarm may be adjusted by clinician.
% SpO₂ Display	Functional arterial hemoglobin oxygen saturation is displayed in units of percentage SpO ₂ .
Limit Mode	Configurable mode that can be set to display either adult or neonatal monitoring mode. (See "Configurable Settings" for additional configurable features.)
Pleth Waveform	Plethysmographic (pleth) waveform is a graphic representation of changes in extremity blood volume during events of cardiac cycle.
Pulse Beat Volume	Sound of each pulse beep may be configured to be off or to a volume level of 1, 2 or 3.
Pulse Rate	Displayed in beats per minute (bpm).
Pulse Rate Alarm Limits	Upper and lower pulse rate alarm limits may be adjusted by clinician.
Trend Data	Tabular display of %SpO ₂ and pulse rate. Display shows average high and low values, and alarm conditions for time period displayed. Up to 24 hours of data is stored.

Features and Displays (Continued)

Features and Definitions (Continued)

Model 8210



SatSeconds

SatSeconds limits controls time %SpO₂ level may fall outside alarm limits before an audible alarm sounds. Method of calculation is as follows:

Number of percentage points %SpO₂ falls outside of alarm limit is multiplied by number of seconds %SpO₂ level remains outside that limit.

Points x Seconds = SatSeconds

Points = %SpO₂ percentage points outside of limit

Seconds = number of seconds %SpO₂ remains at that point outside of limit

Saturation levels may fluctuate rather than remain steady for a period of several seconds. Often, %SpO₂ levels may fluctuate above and below alarm limit, reentering nonalarm range several times. During such fluctuations, SpO₂ Module integrates number of %SpO₂ points, both positive and negative, until either SatSeconds limit (SatSeconds time setting) is reached or %SpO₂ level returns to within a normal range and remains there.

SatSeconds "Safety Net" is for patients with saturation levels having frequent excursions below limit but not staying below limit long enough for SatSeconds time setting to be reached. When 3 or more limit violations occur within 60 seconds, an alarm sounds, even if SatSeconds time setting has not been reached.

SatSeconds Alarm Management Technology

With SatSeconds Alarm Management Technology, upper and lower alarm limits are set in the same way as with traditional alarm management. A SatSeconds limit can be set to allow monitoring of %SpO₂ below selected low alarm limit for a period of time before an audible alarm sounds.

Features and Displays (Continued)

Features and Definitions (Continued)

Model 8220



Fast SAT

When Fast SAT is enabled and there is 1 data point that is significantly different from a previous data point, averaging is disregarded and most recent data point is displayed. For example, if readings were 97%, 96%, 95% and 85%, displayed saturation level would be 85%.

PI

Perfusion Index (PI) is a scaled numeric value derived from magnitude of pulsations displayed on plethysmographic (pleth) waveform. It is calculated as a percentage of pulsatile signal to nonpulsatile signal. PI is used to find best perfused site for sensor placement (larger the PI, stronger the perfusion). Operating range is 0.02 to 20. Desired number is greater than 1 or as large as possible.

Saturation Averaging Time

Averaging time can be set to 2, 4, 8, 10, 12, 14 or 16 seconds.

Sensitivity Mode

Sensitivity mode, normal or maximum, of current monitoring configuration is displayed in options mode. Normal setting is used for normal patient monitoring purposes. Maximum setting is used for improved low perfusion performance.

SET® Technology

Signal Extraction Technology® (SET®) uses adaptive filters to separate arterial signal from nonarterial noise. SET® provides for accurate readings under extreme conditions (such as low perfusion and motion).

Signal I.Q.™ Feature

A visual indication of pulsation at sensor site. Vertical bar height indicates quality of measured signal. Signal I.Q.™ feature is related to proper sensor application, adequate arterial signal and intensity of motion. Use Signal I.Q.™ feature to verify optimal sensor placement.

Features and Displays (Continued)

Operating Features, Controls, Indicators

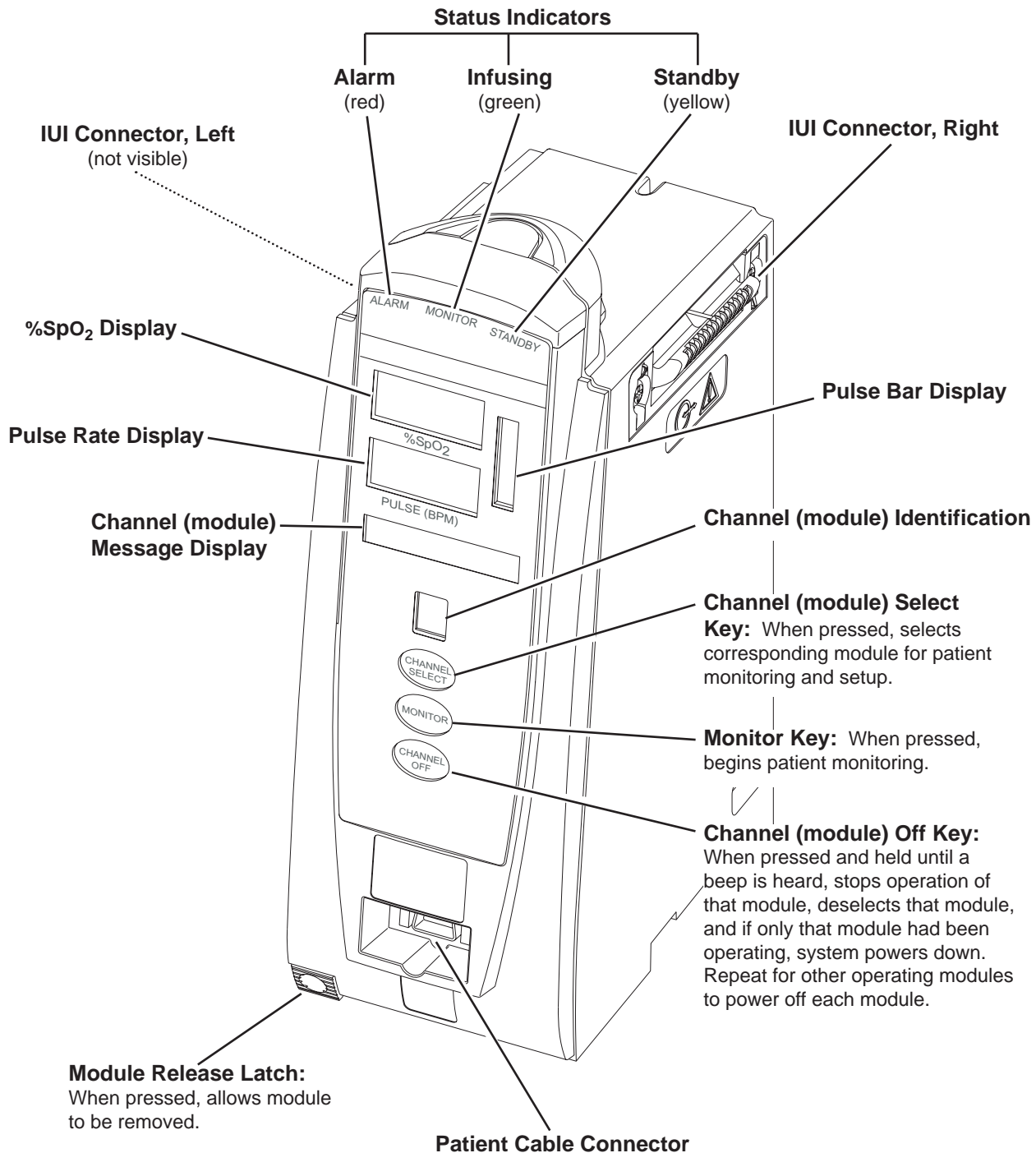

Features and Displays (Continued)

Displays

The displays illustrated throughout this document are for illustration purposes only. The display content varies, depending on configuration settings, hospital-defined Data Set uploaded using the Guardrails® Suite MX, programmed parameters, and many other variables.

Main Display

See the PC Unit Section of this DFU.

SPO2 Main Display

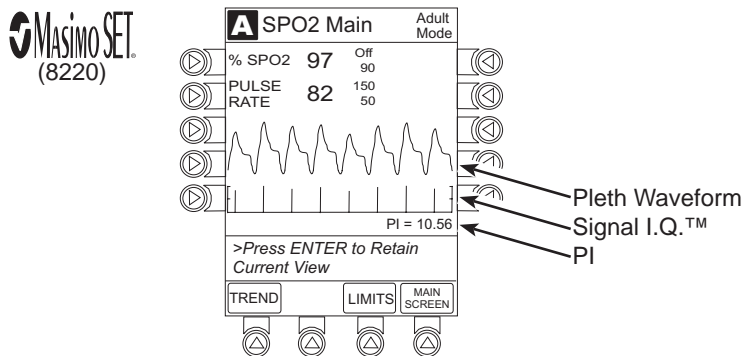
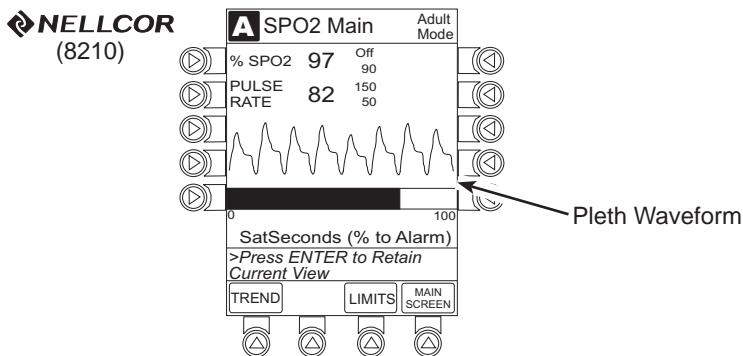

Configurable Settings

See the PC Unit Section of this DFU for system configurable settings.

If the configuration settings need to be changed from the **Factory default** settings, reference the applicable Technical Service Manual or contact Cardinal Health Technical Support, for technical, troubleshooting, and preventive maintenance information.

With the Profiles feature enabled, the settings are configured independently for each profile. A hospital-defined, best-practice Data Set must be uploaded to enable the Profiles feature. Date and Time is a system setting and is the same in all profiles.

Models 8210 and 8220

Feature	Default Setting	Options
Limit Mode	Adult	Adult, Neonatal
Pulse Beep Volume	1	1, 2, 3, Off
Pulse Rate Alarm Limit, High	Adult Mode: 120 bpm Neonatal Mode: 200 bpm	31 - 240 bpm
Pulse Rate Alarm Limit, Low	Adult Mode: 50 bpm Neonatal Mode: 100 bpm	30 - 239 bpm
SpO ₂ Alarm Limit, High	Adult: Off Neonatal: 95%	21 - 100%, Off
SpO ₂ Alarm Limit, Low	Adult: 90% Neonatal: 80%	20 - 99%

Model 8210



Feature	Default Setting	Options
SatSeconds	Off	10, 25, 50, 100 seconds; Off

Configurable Settings (Continued)

Model 8220



Feature	Default Setting	Options
Saturation Averaging Time (display update period)	8 seconds	2, 4, 8, 10, 12, 14, 16 seconds
Sensitivity Mode	Normal	Normal, Maximum

Specifications and Symbols

Specifications

Models 8210 and 8220

Alarms: Audible and visual alarms for high and low saturation and pulse rate, sensor condition, system failure and low battery conditions.

Alarm Limits:	<u>Low</u>	<u>High</u>
Pulse Rate:	30 - 239 bpm	31 - 240 bpm
SpO ₂	20 - 99%	21 - 100%

Dimensions: 3.3" W x 8.9" H x 5.5" D
(8.4 cm W x 22.6 cm H x 14 cm D)

Environmental Conditions:	<u>Operating</u>	<u>Storage/Transport</u>
Temperature Range:	41 - 104° F (5 - 40° C)	-4 - 140° F (-20 - 60° C)
Relative Humidity:	20 - 90% noncondensing	5 - 85% noncondensing
Atmospheric Pressure:	525 - 4560 mmHg (700 - 6080 hPa)	375 - 760 mmHg (500 - 1013 hPa)

Fluid Ingress Protection: IPX1, Drip Proof

Mode of Operation: Continuous

Shock Protection: Type BF

Weight: 2 lbs (0.91 kg)

Specifications and Symbols (Continued)

Specifications (Continued)

Model 8210



Accuracy Tolerance:	<u>Low Perfusion</u> ^①	<u>Adult</u> ^②	<u>Neonate</u> ^②
Pulse Rate:	20 - 250 bpm ±3 digits	20 - 250 bpm ±3 digits	20 - 250 bpm ±3 digits
Functional Saturation:	70 - 100% ±2 digits	70 - 100% ±2 digits	70 - 100% ±3 digits
Display Update Period:	2.25 seconds		
Measurement Range:			
Perfusion	0.03 - 20%		
Pulse Rate	20 - 250 bpm		
SpO ₂	1 - 100%		
Pulse Amplitude Display:	Visual indicators for pulse signals represent proportional pulse amplitude strength.		
Sensor:	Emitted light wavelength range is within 500 - 1000 nm. Output power does not exceed 15 mw.		

Model 8220



Accuracy and Motion Tolerance:	<u>Low Perfusion</u> ^③	<u>Motion</u> ^{④ ⑤}	<u>No Motion</u> ^⑥	<u>Resolution</u>
Pulse Rate:	25 - 240 bpm ±3 digits Adults, Pediatrics, Neonates	25 - 240 bpm ±5 digits Adults, Pediatrics, Neonates	25 - 240 bpm ±3 digits Adults, Pediatrics, Neonates	1 bpm
Saturation:	70 - 100% Adults, Pediatrics: ±2 digits; Neonates: ±3 digits	70 - 100% ±3 digits Adults, Pediatrics, Neonates	70 - 100% Adults, Pediatrics: ±2 digits; Neonates: ±3 digits	1% SpO ₂
Display Update Period:	Approximately 1 second.			

Specifications and Symbols (Continued)

Specifications (Continued)

Model 8220 (Continued)



Measurement Range:

Perfusion	0.02 - 20%
Pulse Rate	25 - 240 bpm
SpO ₂	1 - 100%

Pulse Amplitude Display: Proportional to height of I.Q. signal.

Sensor: Emitted light wavelength range is within 500 - 1000 nm. Output power does not exceed 1 mw.

NOTES:

- ① Specification applies to monitor performance.
- ② Adult specifications are shown for OxiMAX MAX-A and MAX-N sensors. Neonate specifications are shown for OxiMAX MAX-N sensors. Saturation accuracy varies by sensor type.
- ③ Masimo® Board performance has been validated for low perfusion accuracy in bench-top testing against a BIO-TEK simulator and a Masimo® simulator.
- ④ Masimo® Board performance has been validated for motion accuracy in human blood studies on healthy adult volunteers in induced hypoxia studies, while performing rubbing and tapping motions at 2 - 4 Hz at an amplitude of 1 - 2 cm and a nonrepetitive range of 70 - 100% SpO₂ against a laboratory co-oximeter and ECG monitor. This variation equals plus or minus one standard deviation. Plus or minus one standard deviation encompasses 68% of the population.
- ⑤ Masimo® Board performance with Masimo® LNOP® Neo and Neo Pt sensors has been validated for neonatal motion accuracy in human blood studies on neonates, while moving the neonate's foot at 2 - 4 Hz at an amplitude of 1 - 2 cm against a laboratory co-oximeter and ECG monitor. This variation equals plus or minus one standard deviation. Plus or minus one standard deviation encompasses 68% of the population.
- ⑥ Masimo® Board performance has been validated for no-motion accuracy in human blood studies on healthy adult volunteers in induced hypoxia studies, in the range of 70 - 100% SpO₂ against a laboratory co-oximeter and ECG monitor. This variation equals plus or minus one standard deviation. Plus or minus one standard deviation encompasses 68% of the population.

Specifications and Symbols (Continued)

Symbols

See the PC Unit Section of this DFU for system symbols.



Silenced alarm.



Type BF equipment.

Measurement Accuracy

If the accuracy of any measurement does not seem reasonable, first check the patient's vital signs by alternate means and then check the SpO₂ Module to ensure it is functioning properly.

An inaccurate measurement may be caused by:

- Incorrect sensor application or use.
- Significant levels of dysfunctional hemoglobins (such as carboxyhemoglobin or methemoglobin).
- Intravascular dyes (such as indocyanine green or methylene blue).
- Exposure to excessive illumination; such as, a surgical lamp (especially one with a xenon light source), bilirubin lamp, fluorescent light, infrared heating lamp or direct sunlight. ^①
- Prolonged and/or excessive patient movement.
- Venous pulsations.
- Sensor placed on an extremity with a blood pressure cuff, arterial catheter, intravascular line or other causes of insufficient perfusion.
- Nail aberrations, nail polish, fungus, etc. Remove nail polish and/or move sensor to an unaffected site.
- Placement is too close to electrosurgery equipment.
- Defibrillation.

Measurement Accuracy (Continued)

The loss of a pulse signal can occur in any of the following situations:

- Sensor is too tight.
- Exposure to excessive illumination; such as, a surgical lamp (especially one with a xenon light source), bilirubin lamp, fluorescent light, infrared heating lamp or direct sunlight.
- Sensor placed on an extremity with a blood pressure cuff, arterial catheter, intravascular line or other causes of insufficient perfusion.
- Patient has hypotension, severe vasoconstriction, severe anemia or hypothermia, is in cardiac arrest or is in shock.
- There is an arterial occlusion proximal to sensor.
- Placement is too close to electrosurgery equipment.

NOTE:

- ① Exposure to excessive illumination can be corrected by covering the sensor with a dark or opaque material.

Troubleshooting and Maintenance

General

The SpO₂ Module Technical Service Manual is available from Cardinal Health. It includes routine service schedules, interconnect diagrams, component parts lists and descriptions, test procedures, and other technical information, to assist qualified service personnel in repair and maintenance of the instrument's repairable components. Maintenance procedures are intended to be performed only by qualified personnel, using the Service Manual and System Maintenance software.

Alarms and Messages

See the PC Unit Section of this DFU for the following system references:

Alarms, Errors, Messages
Audio Characteristics
Definitions
Radio Frequency Note

Alarms

Models 8210 and 8220

Alarm	Meaning	Response
Bad Sensor	Broken, unknown or nonsystem sensor or patient cable attached.	Check sensor and patient cable. Confirm correct sensor and patient cable are chosen.
Check Sensor - Electrical or Optical Interference	External interference on sensor.	Check sensor. Identify source of external interference if other than sensor.
High Pulse Rate Alarm	High pulse rate alarm limit has been exceeded.	Assess patient's condition. Confirm correct alarm limit values are selected.
High SpO ₂ Alarm	High SpO ₂ alarm limit has been exceeded.	Assess patient's condition. Confirm correct alarm limit values are selected.

Alarms and Messages (Continued)

Alarms (Continued)

Models 8210 and 8220 (Continued)

Alarm	Meaning	Response
Low Pulse Rate Alarm	Low pulse rate alarm limit has been exceeded.	Assess patient's condition. Confirm correct alarm limit values are selected.
Low SpO ₂ Alarm	Low SpO ₂ alarm limit has been exceeded.	Assess patient's condition. Confirm correct alarm limit values are selected.
No Sensor	Sensor not properly attached to patient cable or patient cable not properly attached to SpO ₂ Module.	Attach sensor to patient cable or attach patient cable to SpO ₂ Module.
No Signal	Failure to find a patient signal after 30 seconds of searching.	Check sensor. Confirm correct sensor placement.
Remove Module (Max=1)	More than 1 SpO ₂ Module attached.	Remove additional SpO ₂ Module.
Sensor Off	Sensor not properly attached to patient.	Reattach sensor to patient.

Model 8210



Alarm	Meaning	Response
Check Sensor - High Pulse Amplitude	Artifact interfering with pulse reading.	Check sensor - relocate sensor to a site with less artifact interference.
Check Sensor - Excessive Ambient Light	Light interference on sensor.	Check sensor. Remove or reduce lighting. Cover or reposition sensor.
Check Sensor - Motion Interference	Patient's motion has inhibited monitoring.	Check sensor. Move sensor to a site with less motion.
Check Sensor - No signal	Sensor not properly attached to patient cable or patient cable not properly attached to SpO ₂ Module.	Attach sensor to patient cable or attach patient cable to SpO ₂ Module.

Alarms and Messages (Continued)

Alarms (Continued)

Model 8210 (Continued)

 **NELLCOR**
(8210)

Alarm	Meaning	Response
Check Sensor - Weak Pulse	Patient's low perfusion has inhibited monitoring.	Check sensor. Move sensor to a better perfused site.
Check Sensor - Weak Signal	Low quality of signal being measured.	Check sensor. Confirm correct sensor placement. Move sensor to a better perfused site.

Model 8220

 **MASIMO SET.**
(8220)

Alarm	Meaning	Response
Check Sensor - Light	Light interference on sensor.	Check sensor. Remove or reduce lighting. Cover or reposition sensor.
Check Sensor - Low Perfusion	Patient's low perfusion has inhibited monitoring.	Check sensor. Move sensor to a better perfused site.
Check Sensor - Low Signal I.Q.	Low signal quality being measured.	Check sensor. Confirm correct sensor placement. Move sensor to a better perfused site.

Messages

Model 8210

 **NELLCOR**
(8210)

Message	Meaning	Response
Check Sensor - Electrical or Optical Interference	External interference on sensor.	Check sensor. Identify source of external interference if other than sensor.
Check Sensor - High Pulse Amplitude	Artifact interfering with pulse reading.	Check sensor. Relocate sensor to a site with less artifact interference.
Check Sensor - Excessive Ambient Light	Light interference on sensor.	Check sensor. Remove or reduce lighting. Cover or reposition sensor.

Alarms and Messages (Continued)

Messages (Continued)

Model 8210 (Continued)



Message	Meaning	Response
Check Sensor - Motion Interference	Patient's motion has inhibited monitoring.	Check sensor. Move sensor to a site with less motion.
Check Sensor - Weak Pulse	Patient's low perfusion has inhibited monitoring.	Check sensor. Move sensor to a better perfused site.
Check Sensor - Weak Signal	Low quality of signal being measured.	Check sensor. Confirm correct sensor placement. Move sensor to a better perfused site.

Model 8220



Message	Meaning	Response
Check Sensor - Low Perfusion	Patient's low perfusion has inhibited monitoring.	Check sensor. Move sensor to a better perfused site.
Check Sensor - Low Signal I.Q.	Low signal quality being measured.	Check sensor. Confirm correct sensor placement. Move sensor to a better perfused site.

Inspection Requirements

To ensure the Alaris® System remains in good operating condition, both regular and preventive maintenance inspections are required. Reference the System Maintenance software for detailed instructions.

REGULAR INSPECTIONS

PROCEDURE	FREQUENCY
INSPECT FOR DAMAGE:	
Case	Each usage
IUI Connector	Each usage
Keypad	Each usage
CLEANING	As required
START-UP	Each usage

WARNING

Failure to perform these inspections may result in improper instrument operation.

CAUTION

Regular and preventive maintenance inspections should only be performed by qualified service personnel.

Alaris® EtCO₂ Module Model 8300

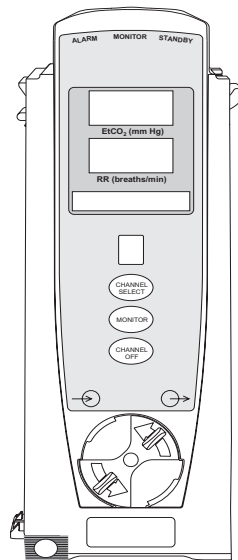

GETTING STARTED

INTRODUCTION.....	5-1
CONNECTING MICROSTREAM® DISPOSABLE	5-2
ATTACHING GAS SCAVENGING SYSTEM	5-3

PROGRAMMING

MONITORING MODE.....	5-5
Setting Alarm Limits.....	5-6
Navigating Trend Data.....	5-7
Navigating PCA/EtCO ₂ Trend Data	5-8
Presilencing Alarm	5-9
CHANNEL OPTIONS	5-9
Changing Limit Mode.....	5-9
Changing Waveform Height.....	5-10
Changing Waveform Time Scale	5-11

GENERAL SETUP AND OPERATION

SYSTEM START-UP / SETUP.....	5-13
------------------------------	------

GENERAL INFORMATION

WARNINGS AND CAUTIONS.....	5-15
General.....	5-15
Microstream® Disposable.....	5-15
MICROSTREAM® DISPOSABLE	5-16
FEATURES AND DISPLAYS.....	5-17
Features and Definitions.....	5-17
Operating Features, Controls, Indicators	5-18
Displays.....	5-19
CONFIGURABLE SETTINGS.....	5-19
SPECIFICATIONS AND SYMBOLS.....	5-20
Specifications.....	5-20
Symbols	5-22
MEASUREMENT ACCURACY	5-22
WAVEFORM ANALYSIS.....	5-23
PRINCIPLE OF OPERATION.....	5-25

TROUBLESHOOTING AND MAINTENANCE

GENERAL.....	5-27
ALARMS AND MESSAGES	5-27
Definitions	5-27
Audio Characteristics.....	5-28
Alarms.....	5-28
Messages.....	5-29
INSPECTION REQUIREMENTS.....	5-30

THIS PAGE
INTENTIONALLY
LEFT BLANK

Introduction

This Section of the DFU provides EtCO₂ Module (Model 8300) instructions and information. It is used in conjunction with:

- EtCO₂ Module Technical Service Manual
- Microstream® Disposable Compatibility Card
- Oridion's Microstream® disposable instructions
- PC Unit Section of this DFU
- System Maintenance software (and its instructions) for Alaris® System check-in, maintenance, and wireless configuration

The EtCO₂ Module is a capnograph indicated for continuous, noninvasive monitoring of end tidal carbon dioxide (EtCO₂), fractional inspired carbon dioxide (FiCO₂) and respiratory rate (RR). The EtCO₂ Module and disposables are indicated for use with intubated and nonintubated adult, pediatric and neonatal patients. It is not intended for direct connection to ventilator or breathing systems. Only one (1) EtCO₂ Module can be connected to the Alaris® System.

The EtCO₂ Module is used with Oridion's patented Microstream® Disposables/circuits for sidestream capnography.

Microstream® Disposable: See "General Information" for "Microstream® Disposable" Information.

Alarms and Messages: See "Troubleshooting and Maintenance" for module-specific alarms and messages.

Contraindications: None known.

Electromagnetic Environment: See "Appendix" Section of this DFU ("Regulations and Standards", "Compliance").

WARNING

Read all instructions, for both the EtCO₂ Module and PC Unit, before using the Alaris® System.

CAUTION

Rx Only

Connecting Microstream® Disposable

1. Open gas inlet/outlet door by turning door counterclockwise until gas inlet is clearly visible. Hold in open position. ①

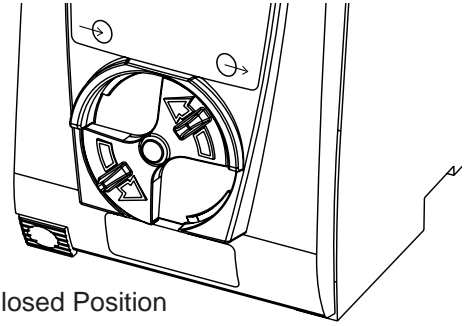

Closed Position

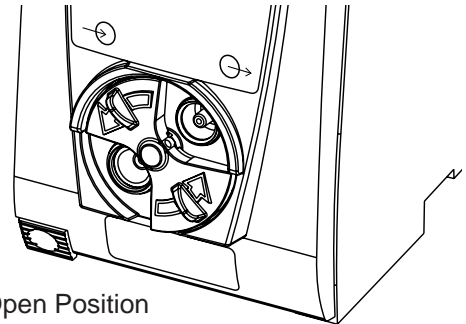

Open Position

2. Connect Microstream® Disposable:
 - a. Press brightly colored end of disposable into gas inlet.
 - b. Turn it clockwise until tightly secured to EtCO₂ Module.

WARNING

Use only Microstream® Disposables. Use of a disposable other than those specified may cause improper EtCO₂ Module performance, resulting in inaccurate readings. For a list of compatible disposables, reference the Microstream® Disposable Compatibility Card (provided separately).

Connecting Microstream® Disposable (Continued)

3. Release door.
4. Connect Microstream® Disposable to patient. Connection site and manner are dependent on patient intubation status and type of Microstream® Disposable being used (reference disposable's directions for use).

NOTE:

- ① The gas inlet is located on the lower left corner of the instrument and is marked with a gas inlet symbol (↻).

Attaching Gas Scavenging System

In the presence of high oxygen or anesthesia concentrations, it may be necessary to connect a gas scavenging system to the EtCO₂ Module.

1. Open gas inlet/outlet door by turning door counterclockwise until gas outlet is clearly visible. Hold in open position. ①
2. Secure gas scavenger system tubing to EtCO₂ Module by firmly pushing tubing into fitting on gas outlet.

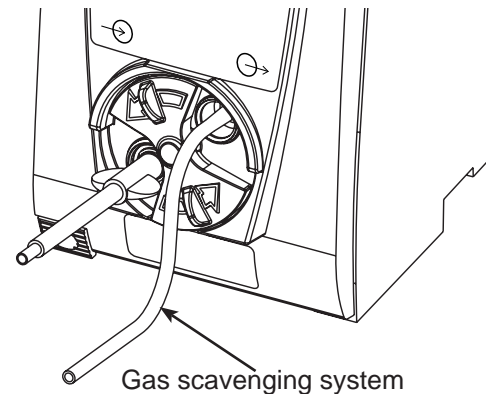

3. Release door.

NOTE:

- ① The gas outlet is located on the lower right corner of the instrument and is marked with a gas outlet symbol (↻).

THIS PAGE
INTENTIONALLY
LEFT BLANK

Display references throughout this procedure are for illustration purposes only.

See "General Information", "Features and Displays" and PC Unit Section of this DFU for information about:

- Displays
- Operating Features, Controls, Indicators

Monitoring Mode

1. Perform following steps (see PC Unit Section of this DFU, "General Setup and Operation", "Start-Up"):
 - a. Power on system.
 - b. Choose **Yes** or **No** to **New Patient?**
 - c. Confirm current profile or select a new profile.
 - d. Enter patient identifier, if required.
2. Connect Microstream® Disposable (see "Getting Started").
3. Press **CHANNEL SELECT** key.
 - **SENSOR WARMING** and then **SEARCHING** appear in Channel Message display until EtCO₂ and respiratory rate readings stabilize (up to 60 seconds).
4. To change settings, see "Setting Alarm Limits" procedure.

OR

-- Continued on Next Page --

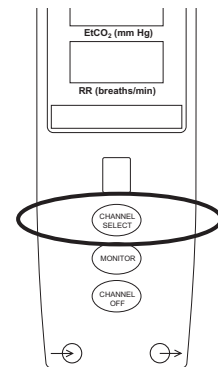

Monitoring Mode (Continued)

To accept settings and begin monitoring, press **ENTER** key.

- **ETCO2 Main** screen displays following information: ①
 Capnography waveform (scale adjustable).
 EtCO₂ value, as well as minimum and maximum EtCO₂ alarm limits.
 Limit Mode (Adult or Neonatal).
 Respiratory rate (RR, breaths/min), as well as minimum and maximum RR alarm limits.

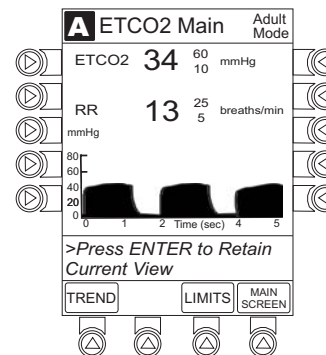

NOTE:

- ① PC Unit display response time is approximately ½ second longer than the EtCO₂ Module response time.

Setting Alarm Limits

1. Press **LIMITS** soft key.
2. To change a limit setting, press soft key next to applicable parameter.
3. Enter a numeric value for selected alarm limit.
4. To move to next limit, press **ENTER** key.
5. To confirm alarm settings and return to **ETCO2 Main** display, press **CONFIRM** soft key.
6. To return to Main Display, press **MAIN SCREEN** soft key.

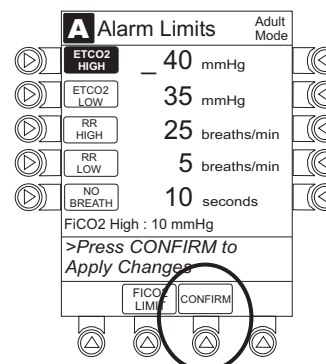
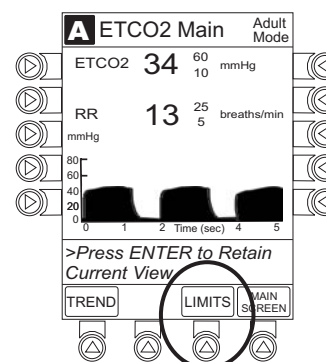

Monitoring Mode (Continued)

Navigating Trend Data

- To view Trend Data, press **TREND** soft key. ① ②

Following information displays:

- TIME** period for data review.
- Average **ETCO2** with high and low values.
- Average respiratory rate (**RR**) with high and low values.
- Alarm icon (⚠) with **Fi** in **TIME** column, to indicate high FiCO_2 alarm limit has been exceeded.
- Alarm icon (⚠) to indicate an alarm limit has been exceeded.
- Alarm icon (⚠) in **RR** column, to indicate a no breath alarm limit has been triggered.

2001-07-06		ETCO2		RR		09:00	
TIME	AVG	MAX	MIN	AVG	MAX	MIN	
22:58 Fi ⚠	40	47	38	13	26	11	⚠
22:28 Fi ⚠	40	44	39	12	19	11	⚠
21:58	41	45	39	13	20	11	
21:28	41	45	34	11	14	10	
20:58	---	---	---	---	---	---	
20:28	39	44	37	12	14	11	

ZOOM: 120 60 30 5 1 minutes

>Press UP/DOWN Keys to Move Cursor.

PAGE UP ZOOM ETCO2 MAIN PAGE DOWN

- To navigate from page to page, press **PAGE UP** and **PAGE DOWN** soft keys.
- To scroll data 1 row at a time, press \uparrow or \downarrow key.

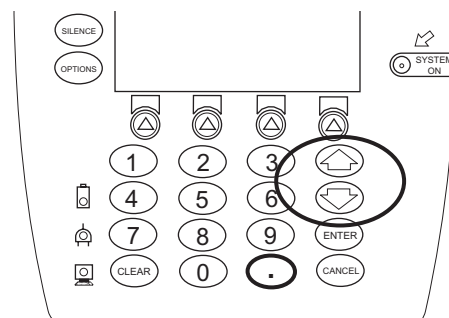

- To change **TIME** increments for data review, move cursor to desired time period and press **ZOOM** soft key.

- New time increments display.
- Each press of **ZOOM** soft key changes time increments.

2001-07-06		ETCO2		RR		09:00	
TIME	AVG	MAX	MIN	AVG	MAX	MIN	
22:28 Fi ⚠	40	44	39	12	16	11	
21:58 Fi ⚠	41	45	39	13	20	11	
21:28	41	45	34	11	14	10	
20:58	---	---	---	---	---	---	
20:28	39	44	37	12	14	11	
19:58	39	44	37	12	14	11	

ZOOM: 120 60 30 5 1 minutes

>Press UP/DOWN Keys to Move Cursor.

PAGE UP ZOOM ETCO2 MAIN PAGE DOWN

- To return to **ETCO2 Main** display, press **ETCO2 MAIN** soft key.
- To return to Main Display, press **MAIN SCREEN** soft key.

Monitoring Mode (Continued)

Navigating Trend Data (Continued)

NOTES:

- ① Tabular information is not updated while the **Trend Data** view is displayed. The tabular data is updated, using the new trend data stored in the EtCO₂ Module, after leaving the Trend Data view. To view the latest data, return to the **Trend Data** view.
- ② If no EtCO₂ or respiratory rate values are available for the time period displayed, dashes (---) are displayed.

Navigating PCA / EtCO₂ Trend Data

To access and view shared trend data when a PCA Module is present, perform the following steps.

1. To view **ETCO2 Main** display, press **CHANNEL SELECT** key.
2. To access option to view trend data, press **OPTIONS** key.
3. To view **Trend Data**, press **PCA/EtCO2 Trend data** soft key.

Following information displays:

- **TIME** period for data review.
 - Average **ETCO2**.
 - Average respiratory rate (**RR**).
 - Alarm icon (▲).
 - **TOTAL DOSE** of medication infused through PCA Module (includes continuous infusion, loading dose, bolus, and PCA dose).
4. See "Navigating Trend Data" procedure for instructions on how to:
 - Navigate from page to page.
 - Change **TIME** increments.
 - Return to **ETCO2 MAIN** display.
 - Return to Main Display.

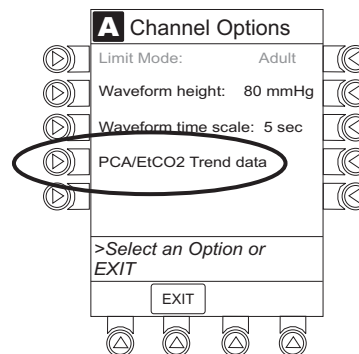

TIME	TOTAL DOSE (mg)	ETCO2 AVG	RR AVG
08:01	---	40	13 ▲
08:02	2.55	40	12
08:03	1.2	41	13
08:04	5.01	41 ▲	11
08:05	---	---	---
08:06	2	39	12

Monitoring Mode (Continued)

Presilencing Alarm

1. To presilence alarm, press **SILENCE** key.
 - All monitoring alarms are silenced for 120 seconds. Subsequent infusion alarms are not silenced.

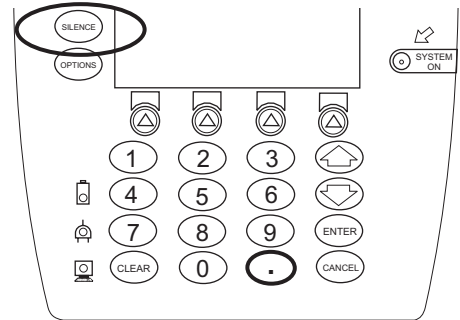

2. To cancel presilence alarm and return to alarmable mode:
 - Press **CHANNEL SELECT** key.
 - Press **CANCEL SILENCE** soft key.

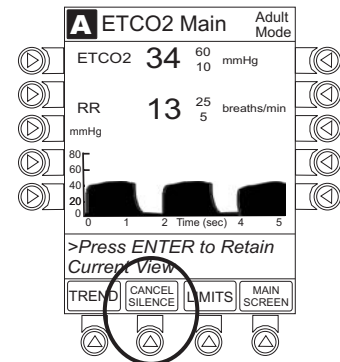

Channel Options

Changing Limit Mode

The following procedure can be performed only when the Guardrails® Suite MX is not enabled (profile option not being used for programming).

1. Press **Limit Mode** soft key.

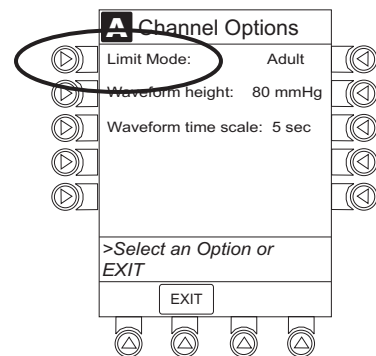

Channel Options (Continued)

Changing Limit Mode (Continued)

2. To change **Limit Mode Setup**, press applicable soft key.

OR

To leave **Limit Mode Setup** unchanged and return to **ETCO2 Main** display, press **EXIT** soft key.

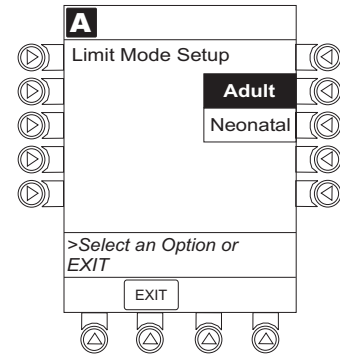

Changing Waveform Height

1. Press **Waveform height** soft key.

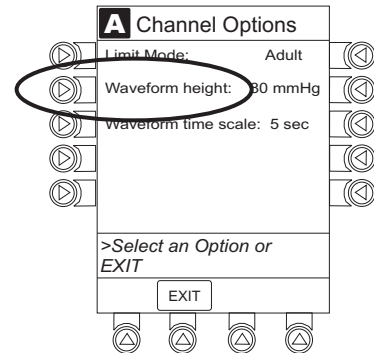

2. To change **Waveform Height**, select applicable range limit.

- **60 mmHg**: Displays a waveform for EtCO₂ values within 0 – 60 mmHg range. If EtCO₂ value exceeds that range, **Waveform Out of Range; Adjust Scaling** message displays until waveform falls back into range or 0 – 99 mmHg option is selected.
- **99 mmHg**: Displays a waveform for full EtCO₂ value range, 0 – 99 mmHg.

3. To return to **ETCO2 Main** display, press **EXIT** soft key.

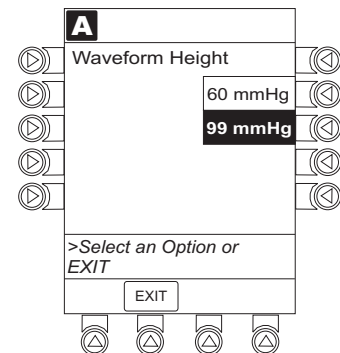

Channel Options (Continued)

Changing Waveform Time Scale

1. Press **Waveform time scale** soft key.

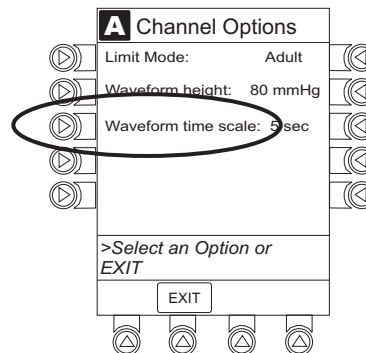

2. To change **Waveform Time Scale**, select applicable time scale.

OR

To leave **Waveform Time Scale** unchanged and return to **ETCO₂ Main** display, press **EXIT** soft key.

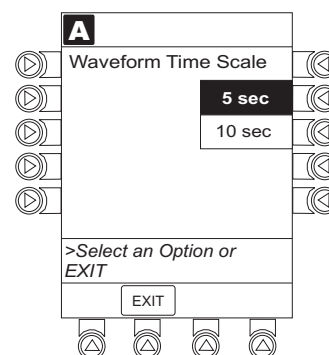

THIS PAGE
INTENTIONALLY
LEFT BLANK

General Setup and Operation

System Start-Up / Setup

See the PC Unit Section of this DFU, "General Setup and Operation", for various system start-up and setup procedures.

THIS PAGE
INTENTIONALLY
LEFT BLANK

Warnings and Cautions

General

WARNINGS

- **EtCO₂ and respiratory rate readings** can be affected by certain ambient environmental and patient conditions.
- The EtCO₂ Module is **not to be used as an apnea monitor**.
- The EtCO₂ Module is intended only as an **adjunct in patient assessment**. It must be used in conjunction with clinical signs and symptoms.
- If uncertain about **measurement accuracy**, assess patient's condition and vital signs by alternate means, then ensure EtCO₂ Module is functioning correctly.
- **Do not lift** the EtCO₂ Module by Microstream® Disposable because it may disconnect from the instrument, causing it to drop on the patient. Do not place the EtCO₂ Module in any position that may cause it to fall onto the patient.
- Do not use the EtCO₂ Module or Microstream® Disposable inside a **hyperbaric chamber**.
- **Respond immediately to system alarms**; patient monitoring may cease under certain alarm conditions.

Microstream® Disposable

WARNINGS

- Do not use a connector or Microstream® Disposable that **appears damaged**.
- The Microstream® Disposable **disconnect error message** and associated alarm indicate the Microstream® Disposable is disconnected. Check the Microstream® Disposable connection and, if necessary, replace the Microstream® Disposable.
- **Use only Microstream® Disposables**. Use of a disposable other than those specified may cause improper EtCO₂ Module performance, resulting in inaccurate readings. For a list of compatible disposables, reference the Microstream® Disposable Compatibility Card (provided separately).

Warnings and Cautions (Continued)

Microstream® Disposable (Continued)

WARNINGS

- Before use, read **Microstream® Disposable directions for use**, including all warnings, cautions and instructions.
- **Carefully locate the patient Microstream® Disposable** to reduce the possibility of patient entanglement or strangulation.

CAUTIONS

- **Do not immerse or dampen** the Microstream® Disposable.
- The Microstream® Disposables are **designed for single patient use** and are not to be reprocessed. Do not attempt to disinfect or flush the disposable as the EtCO₂ Module can be damaged.

Microstream® Disposable

When selecting a Microstream® Disposable, consider the patient's weight, condition and intubation status. For more information on Microstream® Disposables, contact Oridion at <http://www.oridion.com> or 1-888-ORIDION.

For a list of compatible disposables, reference the Sensor and Cable Compatibility Card (provided separately).

Features and Displays

Features and Definitions

See the PC Unit Section of this DFU for system features and definitions.

BPM	Breaths per minute.
Capnography Waveform	Real-time graphical display of CO ₂ concentration throughout respiration.
Data Display	Waveforms, trended data, and numerical values are displayed.
EtCO₂	CO ₂ concentration in mmHg at end of exhalation.
FiCO₂	Fractional-inspired CO ₂ ; CO ₂ concentration present during inhalation.
Limit Mode	Configurable mode that can be set to display either adult or neonatal monitoring mode. (See "Configurable Settings" for additional configurable features.)
Microstream® Disposable	Oridion's line of Microstream® Disposables are available for neonatal, pediatric and adult patients. Patients may be intubated or nonintubated.
Programmable Alarm Limits	Alarm limits for EtCO ₂ , FiCO ₂ , respiration rates and No Breath time periods are programmable.
Respiratory Rate	Patient's respiratory rate in breaths per minute (breaths/minute).
Trend Data	Tabular display of EtCO ₂ and respiratory rate. Display shows average, high and low values and alarm conditions for time period displayed. Up to 24 hours of data is stored.

Features and Displays (Continued)

Operating Features, Controls, Indicators

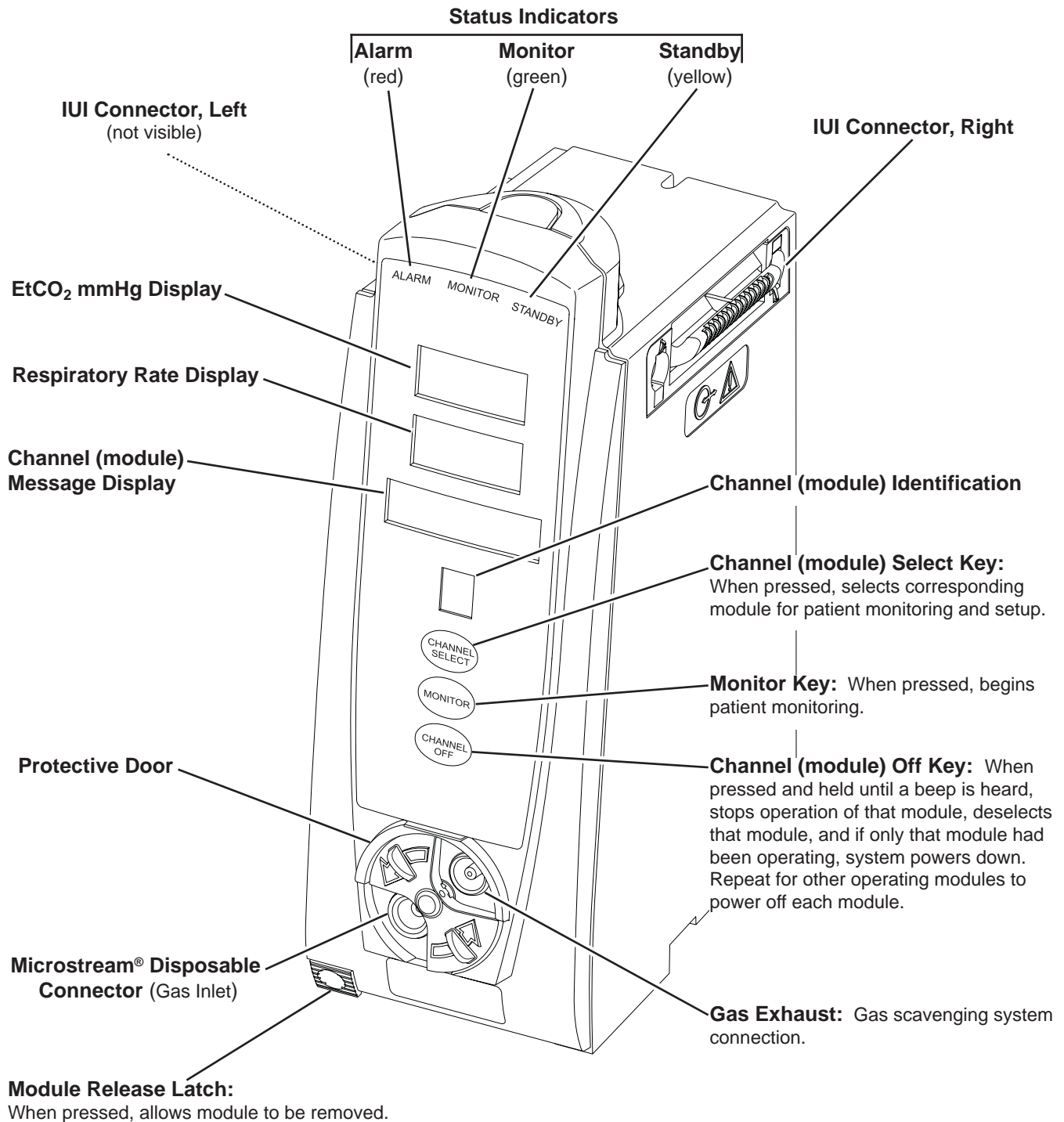

Features and Displays (Continued)

Displays

The displays illustrated throughout this document are for illustration purposes only. The display content varies, depending on configuration settings, type of disposable in use, hospital-defined Data Set uploaded using the Guardrails® Suite MX, programmed parameters, and many other variables.

Main Display

See the PC Unit Section of this DFU.

Configurable Settings

See the PC Unit Section of this DFU for system configurable settings.

If the configuration settings need to be changed from the **Factory default** settings, reference the applicable Technical Service Manual or contact Cardinal Health Technical Support, for technical, troubleshooting, and preventive maintenance information.

With the Profiles feature enabled, the settings are configured independently for each profile. A hospital-defined, best-practice Data Set must be uploaded to enable the Profiles feature. Date and Time is a system setting and is the same in all profiles.

Feature	Default Setting	Options
EtCO ₂ Alarm Limit, High	Adult: 60 mmHg Neonatal: 60 mmHg	5 - 99 mmHg
EtCO ₂ Alarm Limit, Low	Adult: 10 mmHg Neonatal: 10 mmHg	0 - 98 mmHg
FiCO ₂ Alarm Limit, High	Adult: 8 mmHg Neonatal: 8 mmHg	2 - 99 mmHg
Limit Mode	Adult	Adult or Neonatal
No Breath Alarm	Adult: 30 seconds Neonatal: 20 seconds	10 - 60 seconds
Respiratory Rate Alarm Limit, High	Adult Mode: 35 bpm Neonatal Mode: 150 bpm	1 - 150 bpm
Respiratory Rate Alarm Limit, Low	Adult Mode: 6 bpm Neonatal Mode: 12 bpm	0 - 149 bpm

Specifications and Symbols

Specifications

Accuracy:

EtCO₂ Readings:

CO ₂ Partial Pressure (at sea level)	Accuracy
0 - 38 mmHg	±2 mmHg
39 - 99 mmHg	± (5% of reading + 0.08% for every 1 mmHg above 38 mmHg)

Above 55° C module temperature, ±1 mmHg or 2.5% (whichever is greater), has to be added to tolerance of accuracy specifications

Respiration Rate:

Measured in range of 0 - 150 bpm with following accuracy:

0 - 70 bpm: ±1 bpm
 71 - 120 bpm: ±2 bpm
 121 - 150 bpm: ±3 bpm

Alarm Limits:

	<u>Low</u>	<u>High</u>
EtCO ₂ :	0 - 98 mmHg	5 - 99 mmHg
FiCO ₂ :	N/A	2 - 99 mmHg
No Breath:	10 - 60 sec	N/A
Respiration Rate:	0 - 149 breaths/min	1 - 150 breaths/min

Alarms:

Audible and visual alarms for high and low EtCO₂ and respiratory rate, high FiCO₂, Microstream® Disposable condition, system failure, no breath, and low battery conditions.

Barometric Pressure:

EtCO₂ Module is equipped with automatic barometric pressure compensation and fully complies with EN 864/1997 standards. There are no quantitative effects of barometric pressure for this device.

CO₂ Range:

Measures and reports partial pressures of CO₂ in the range of 0 - 99 mmHg at sea level. EtCO₂ and FiCO₂ values are calculated for all valid breaths.

Dimensions:

3.3" W x 8.9" H x 5.5" D
 (8.4 cm W x 22.6 cm H x 14 cm D)

Specifications and Symbols (Continued)

Specifications (Continued)

Environmental Conditions:	<u>Operating</u>	<u>Storage/Transport</u>
Altitude:	-380 - 4570 m (-1250 - 15,000 ft)	-380 - 4570 m (-1250 - 15,000 ft)
Atmospheric Pressure:	525 - 795 mmHg (700 - 1060 hPa)	375 - 760 mmHg (500 - 1013 hPa)
Relative Humidity:	20 - 90% Noncondensing	5 - 85% Noncondensing
Sound Pressure:	34.9 db	N/A
Temperature Range:	41 - 104° F (5 - 40° C)	-4 - 140° F (-20 - 60° C)
Flow Rate:	Nominally 50 mL/min -7.5 +15 mL/min	
Fluid Ingress Protection:	IPX1, Drip Proof	
Frequency Response:	EtCO ₂ accuracy applies for breath rates of up to 80 bpm. For maintaining accuracy for respiration rates above 80 bpm, accuracy complies with EN 864/ISO 9918 (4 mmHg or ±12% of reading, whichever is greater) for EtCO ₂ values exceeding 18 mmHg. To achieve specified accuracies for breath rates above 60 bpm, Microstream® neonatal airway adapter M1996A must be used.	
Gas Interference:	Following liquid anesthetics have been tested and were found to have no effect: Desflurane Enflurane Halothane Isoflurane Sevoflurane	
Internal Power Source:	Operating time (fully charged): 5.5 hours	
Measurement Range:		
EtCO ₂ :	0 - 99 mmHg	
FiCO ₂ :	0 - 99 mmHg	
Respiratory Rate:	0 - 150 bpm	
Mode of Operation:	Continuous	
Shock Protection:	Type BF, Defibrillator Proof	

Specifications and Symbols (Continued)

Specifications (Continued)

System Response Time:	EtCO ₂ Module response: 2.9 seconds typical (includes rise time of 190 msec maximum and delay time of 2.7 seconds typical). PC Unit display response: approximately ½ second longer than EtCO ₂ Module response.
Warm-Up Time:	30 seconds typical
Weight:	2.5 lbs (0.91 kg)

Symbols

See the PC Unit Section of this DFU for system symbols.



Type BF defibrillation-proof equipment.



Gas inlet.



Gas outlet.



Silenced alarm.



Displays in Trend Data screen to identify an exceeded alarm limit.



Displays in Trend Data screen to identify an exceeded no breath alarm limit.

Measurement Accuracy

The EtCO₂ Module has been designed and manufactured to exacting standards and should perform well within given environmental and performance standards. There may be certain conditions under which an inaccurate measurement or the loss of respiratory rate signal may occur. Examples of these conditions are as follows:

WARNINGS

- If uncertain about **measurement accuracy**, assess patient's condition and vital signs by alternate means, then ensure EtCO₂ Module is functioning correctly.
- **Leaks or internal venting** of sampled gas may affect accuracy.

Measurement Accuracy (Continued)

An inaccurate EtCO₂ measurement may be caused by:

- Incorrect disposable application or use.
- Microstream® Disposable disconnected or not securely connected to EtCO₂ Module.
- Airway connection clogged, twisted, or leaking.
- Placement too close to electrosurgery equipment.
- Mechanically ventilated patient breathes spontaneously.

Loss of a respiratory rate signal can occur in any of the following situations:

- Incorrect disposable application or use.
- Microstream® Disposable disconnected or not securely connected to EtCO₂ Module.
- Airway connection clogged, twisted, or leaking.
- Patient not breathing.
- Placement too close to electrosurgery equipment.

Waveform Analysis

The EtCO₂ Module provides the option to display EtCO₂ readings as a waveform. The following graph is an example of a normal waveform (normal ventilation, 35 - 45 mmHg). ^①

- A - B:** baseline period of no CO₂; end of inhalation
- B - C:** rapid rise in CO₂
- C - D:** alveolar plateau
- D:** end of expiration; end tidal CO₂ (EtCO₂)
- D - E:** inhalation

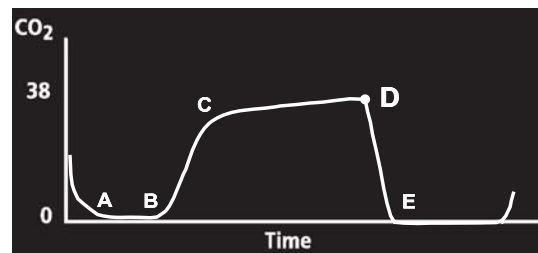

Waveforms can be used to troubleshoot problems with equipment or monitor configuration, as well as to monitor a patient's clinical status. The following graphs are examples of common problems identifiable through waveform analysis. These are examples only and do not represent all potential abnormal waveforms. Abnormal waveforms are not always associated with alarms.

Waveform Analysis (Continued)

Waveform

Possible Causes

Hypoventilation



- overmedication

Hyperventilation



- respiratory distress

Partial Airway Obstruction



- relaxation of upper airway
- head position

Hypoventilation with Shallow Breathing

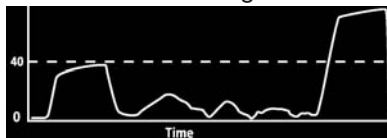

- medication effect
- low tidal volume

No Breath Detected

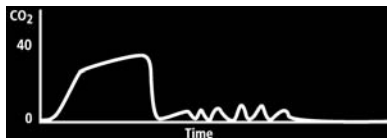

- apnea
- very shallow breathing
- overmedication
- displaced cannula

NOTE:

- ① In the event the EtCO₂ value is above the waveform display range, the top of the waveform will be clipped. Numerical EtCO₂ values continue to be displayed on both the EtCO₂ Module and PC Unit.

Principle of Operation

The EtCO₂ Module uses Oridion's patented Microstream[®] nondispersive infrared (NDIR) spectroscopy to continuously measure the amount of CO₂ during every breath, the amount of CO₂ present at the end of exhalation (EtCO₂) and during inhalation (FiCO₂), and the Respiratory Rate. The EtCO₂ Module is a side stream capnograph.

The Microstream[®] Disposables deliver a sample of the inhaled and exhaled gases from the ventilator disposable or directly from the patient (via an oral/nasal cannula) into the monitor for CO₂ measurement. Moisture and patient secretions are extracted from the sample by the Microstream[®] inline filter while maintaining the shape of the CO₂ waveform.

The 50 mL/min sampling flow rate reduces liquid and secretion accumulation, decreasing the risk of obstruction in the sample pathway in humid ICU environments. The small sample size eliminates the need for water traps and prevents excess fluid accumulation.

The EtCO₂ Module draws a gas sample through a microsample cell (15 microliters). This extremely small volume is quickly flushed, allowing for a rise time of approximately 190 ms and accurate CO₂ readings, even at high respiration rates.

The Microbeam IR source illuminates the microsample cell and the reference channel. This proprietary IR light source generates only the specific wavelengths characteristic of the CO₂ absorption spectrum. The IR light that passes through the microsample cell and the IR light that passes through the reference channel are measured by IR detectors.

The microcomputer in the EtCO₂ Module calculates the CO₂ concentration by comparing the signals from both channels.

No operator intervention is required for routine moisture or condensate.

All Microstream[®] Disposables contain an inline hydrophobic filter to extract condensate and/or patient secretions while maintaining measurement and waveform integrity. For humid conditions within the operating parameters of the EtCO₂ Module and Microstream[®] Disposables, humidity has no quantitative effect on the CO₂ concentration, given the small 50 mL/min sample size rate. In high humidity environments or extended monitoring periods (24 - 72 hours), only Microstream[®] Disposables designed for those instances should be used.

Principle of Operation (Continued)

In the event of humidity or condensate outside the EtCO₂ Module's operating specifications, the EtCO₂ Module will present a "Remove Blocked Disposable" message.

Due to the relatively small sampling size needed for EtCO₂ readings, partial pressure does not affect the ability of the EtCO₂ Module to measure EtCO₂, as long as the 50 mL/min rate can be achieved.

Microstream® Disposables are single-use, disposables which must be changed with each use. The manufacturer's sample flow, 50 mL/min, does not affect the disposable's life; however, humidity and specific patient conditions may shorten the effective life of the disposables. Microstream® Disposables are rated for up to 24 hours and 72 hours use, depending on the specific Microstream® Disposable.

The EtCO₂ Module provides readings in compliance with BTPS (body temperature, pressure, saturation) standards.^① There is no affect on accuracy due to cyclic pressure up to 10 kPa.

NOTE:

- ① BTPS (body temperature, pressure, saturation assumed 37° C, 47 mmHg) calculations are made according to:

$$PCO_2 = FCO_2 \times (Pb - 47)$$

Where:

FCO₂ is fractional concentration of CO₂ in dry gas and

FCO₂ = % CO₂/100.

Pb is ambient pressure.

PCO₂ is partial pressure of CO₂ at BTPS.

Troubleshooting and Maintenance

General

The EtCO₂ Module Technical Service Manual is available from Cardinal Health. It includes routine service schedules, interconnect diagrams, component parts lists and descriptions, test procedures, and other technical information, to assist qualified service personnel in repair and maintenance of the instrument's repairable components. Maintenance procedures are intended to be performed only by qualified personnel, using the Service Manual and System Maintenance software.

Alarms and Messages

See the PC Unit Section of this DFU for the following system references:

Alarms, Errors, Messages
Audio Characteristics
Definitions
Radio Frequency Note

Definitions

Calibration Check A technical procedure, outlined in Technical Service Manual, to verify instrument calibration. When instrument reaches operating hour requirement (4000 hours or 1 year, whichever comes first), "Calibration Check Required" message appears at each system power up until calibration check is performed. Once check is completed, message disappears and internal clock resets.

Alarms and Messages (Continued)

Audio Characteristics

Type	Sound	Notes
EtCO ₂ Alarm (HIGH PRIORITY)	A sequence of 5 beeps	Variable volume; can be silenced for 2 minutes.
EtCO ₂ Alarm (LOW PRIORITY)	One long beep approximately every 4 seconds	Variable volume; can be silenced for 2 minutes.
EtCO ₂ Error (Hardware Detected)	A single alarm tone volume	Fixed maximum decibel volume; cannot be silenced.
EtCO ₂ Error (Software Detected)	Pairs of long beeps	Fixed maximum decibel volume; can be silenced for 2 minutes.

Alarms

High Priority Alarm	Meaning	Response
CHANNEL ERROR	Hardware failure detected by software.	To silence alarm and continue operation of unaffected instrument, press CONFIRM soft key. Replace with operational instrument, as needed.
DISPOSABLE DISCONNECTED	Microstream® Disposable removed from instrument during monitoring mode.	Attach Microstream® Disposable to instrument.
HIGH ETCO2	EtCO ₂ value is above specified limit.	Assess patient condition. Confirm correct alarm limit values are selected.
HIGH FICO2	FiCO ₂ value is above specified limit.	Assess patient condition. Confirm correct alarm limit values are selected.
HIGH RR	Respiratory rate is above specified limit.	Assess patient condition. Confirm correct alarm limit values are selected.
LOW ETCO2	EtCO ₂ value is below specified limit.	Assess patient condition. Confirm correct alarm limit values are selected.

Alarms and Messages (Continued)

Alarms (Continued)

High Priority Alarm	Meaning	Response
LOW RR	Respiratory rate is below specified limit.	Assess patient condition. Confirm correct alarm limit values are selected.
NO BREATH DETECTED	No breath detected for a specified period of time.	Assess patient condition. Check Microstream® Disposable. Confirm correct disposable is chosen and correct disposable placement.
Low Priority Alarm		
Disconnect Occluded Disposable	Purging operation failed	Check Microstream® Disposable. Obtain a new Microstream® Disposable. Attach Microstream® Disposable to patient and module.

Messages

Message	Meaning	Response
Autozero (in progress)	EtCO ₂ Module performs a baseline by sampling CO ₂ present in ambient air.	Wait for instrument to complete its auto-zeroing function. After auto-zero cycle is complete, instrument begins measurement again. No user intervention is required.
Clearing Disposable	Microstream® Disposable blocked.	Check Microstream® Disposable. Wait for purging to complete.
Disposable Disconnected	No Microstream® Disposable present and instrument not in monitoring mode.	Attach Microstream® Disposable to patient and instrument to begin monitoring.
Patient Not Detected	Monitor or Channel Select key pressed and patient not detected.	Assess patient condition. Check disposable.

Inspection Requirements

To ensure the Alaris® System remains in good operating condition, both regular and preventive maintenance inspections are required. Reference the System Maintenance software for detailed instructions.

REGULAR INSPECTIONS

PROCEDURE	FREQUENCY
INSPECT FOR DAMAGE:	
Case	Each usage
IUI Connector	Each usage
Keypad	Each usage
CLEANING	As required
START-UP	Each usage

WARNING

Failure to perform these inspections may result in improper instrument operation.

CAUTION

Regular and preventive maintenance inspections should only be performed by qualified service personnel.

Alaris® Auto-ID Module Model 8600

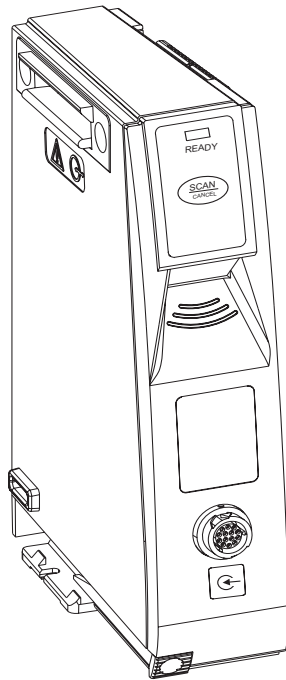

GETTING STARTED

INTRODUCTION.....	6-1
-------------------	-----

PROGRAMMING

PATIENT IDENTIFICATION	6-3
New Patient	6-3
While Infusion is in Progress	6-4
AUTHORIZED USER MODE	6-5
PRIMARY INFUSION	6-6
SECONDARY INFUSION	6-7

GENERAL SETUP AND OPERATION

SYSTEM START-UP / SETUP.....	6-9
------------------------------	-----

GENERAL INFORMATION

WARNINGS AND CAUTIONS	6-11
HAND-HELD SCANNER.....	6-12
FEATURES.....	6-12
Features and Definitions.....	6-12
Operating Features, Controls, Indicators	6-13
CONFIGURABLE SETTINGS	6-14
SPECIFICATIONS AND SYMBOLS.....	6-14
Specifications	6-14
Symbology	6-16
Symbols	6-16

TROUBLESHOOTING AND MAINTENANCE

GENERAL.....	6-17
ALARMS, ERRORS, MESSAGES.....	6-17
INSPECTION REQUIREMENTS.....	6-17

THIS PAGE
INTENTIONALLY
LEFT BLANK

Introduction

This Section of the DFU provides Auto-ID Module (Model 8600) instructions and information. It is used in conjunction with:

- Auto-ID Module Technical Service Manual
- Module-specific Sections of this DFU
- PC Unit Section of this DFU
- System Maintenance software (and its instructions) for Alaris® System check-in, maintenance, and wireless configuration

The addition of the Auto-ID Module to the Alaris® System combines Guardrails® Suite MX with dose limit technology and bar code technology to provide a new level of medication safety. The Auto-ID Module contains an internal bar code image scanner and supports the external scanner supplied by Cardinal Health. Scanning a bar-coded patient identification band automatically captures the patient ID, making it available for association with CQI event logs as well as for verifying the right patient. In addition, using the scanner allows an IV solution drug and concentration to be automatically selected from the Drug Library. Scanned solution containers can be used for Pump, Syringe and PCA infusions. Only one (1) Auto-ID Module can be connected to the Alaris® System but it can be added as a fifth module.

The Alaris® System with the Auto-ID Module is intended to provide trained healthcare caregivers a way to automate infusion parameter input, thereby decreasing the number of manual steps necessary to enter infusion data. All data entry and infusion parameter validation is performed by the trained healthcare professional according to a physician's order.

Electromagnetic Environment: See "Appendix" Section of this DFU ("Regulations and Standards", "Compliance").

WARNING

Read all instructions, for both the Auto-ID Module and PC Unit, before using the Alaris® System.

CAUTION

Rx Only

THIS PAGE
INTENTIONALLY
LEFT BLANK

Patient Identification

Associating the PC Unit with a patient provides a means of identifying the module(s) that will deliver IV medications to that particular patient.

New Patient ^④

To associate the PC Unit with a new patient ID:

1. Attach hand-held scanner to connection port on Auto-ID Module. Ensure secure circuit connection.
2. Power on PC Unit.
3. To select **New Patient?**, press **Yes** soft key.
4. To accept current profile, press **Yes** soft key.

OR

To proceed to profile selection screen, press **No** soft key.

5. To accept profile selection, press **CONFIRM** soft key.
 - **Patient ID Entry** screen appears. ^①
 - Green **READY** LED illuminates, indicating system is ready to scan.

WARNING

Use only the hand-held external scanner supplied by Cardinal Health. Using other accessories may result in **increased emissions or decreased immunity** of the Alaris[®] System.

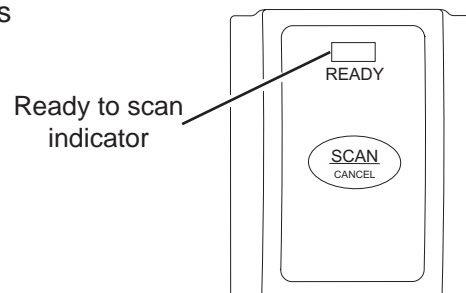

Patient Identification (Continued)

New Patient ^④ (Continued)

6. To scan bar code on patient identification band, press scan trigger on hand-held scanner. ^{② ③}
 - If scan is successful, an audible tone sounds and patient ID appears on Main Display.
 - If profile is configured in Authorized User Mode, **PANEL LOCKED** screen appears.
7. To unlock panel, clinician's ID must be scanned.

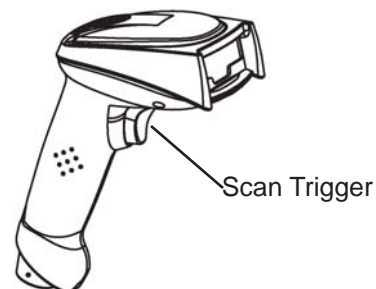

NOTES:

- ① Automatic display of **Patient ID Entry** screen should be enabled in the System Configuration settings.
- ② If the patient ID is not entered at this time, it can still be entered later.
- ③ Patient ID may be entered manually using the PC Unit keypad (see PC Unit Section of this DFU).
- ④ When a questionable bar code is scanned at the main screen and the panel is unlocked, a prompt to confirm the type of bar code scanned appears. This occurs whether the Authorized User Mode is enabled or disabled.

While Infusion is in Progress

To associate the PC Unit with a patient ID when patient ID screen is not shown:

1. Attach hand-held scanner to connection port on Auto-ID Module. Ensure secure circuit connection.
2. To scan bar code on patient identification band, press scan trigger on hand-held scanner. ^①
 - If scan is successful, an audible tone sounds and patient ID appears on Main Display.

NOTE:

- ① Patient ID may be entered manually using the PC Unit keypad (see PC Unit Section of this DFU).

CAUTIONS

- **CLASS 1 LED PRODUCT:** Do not stare into the beam or allow beam to strike patient's face.
- **Always verify** that information displayed on the PC Unit matches scanned data.

CAUTIONS

- **CLASS 1 LED PRODUCT:** Do not stare into the beam or allow beam to strike patient's face.
- **Always verify** that information displayed on the PC Unit matches scanned data.

Authorized User Mode ^① ^② ^③ ^④

Authorized User Mode is a feature that combines the PC Unit tamper resist feature with the Auto-ID application. This feature is designed to ensure that only clinicians with a bar code on their ID badge can program the Alaris® System.

When this feature is enabled, the PC Unit automatically enables tamper resist mode upon power on and 5 minutes after programming is completed. To unlock the keypad, the user must scan their ID badge or use the **OPTIONS** menu to manually input their ID number.

To power on the PC Unit with Authorized User Mode enabled:

1. Power on system and associate patient ID (see "Patient Identification" procedure).
 - Upon successful entry of patient ID, PC Unit automatically enables tamper resist feature.
2. To disable tamper resist, press **SCAN** key and scan clinician ID badge.
3. Program infusion.
 - When no keys have been pressed on PC Unit for a five-minute period, tamper resist mode is automatically enabled.

NOTES:

- ① In a very low battery condition, with less than 5 minutes of battery time remaining, the scanner is disabled. In this situation, disable tamper resist by pressing the Tamper Resist Switch on the back of the PC Unit for 2 seconds.
- ② The Authorized User Mode is only enabled if the feature is enabled in the selected profile and if there is an Auto-ID Module attached to the PC Unit.
- ③ If the system is configured to do so, it is possible to disable the Authorized User Mode without scanning a clinician's ID; press and hold the Tamper Resist Switch (on back of PC Unit) for 3 - 4 seconds.
- ④ When a questionable bar code is scanned at the main screen and the panel is unlocked, a prompt to confirm the type of bar code scanned appears. This occurs whether the Authorized User Mode is enabled or disabled.

Primary Infusion

Utilizing the Auto-ID Module to scan IV medication containers provides the ability to verify the right medication and concentration, and enhances safety through the use of the Guardrails® Suite MX. It compares the medication identifier from the IV container bar code with the medication identifier from the Drug Library. If the patient ID is in the IV container bar code, the system also verifies the right patient.

When the green **READY** LED illuminates, the system is ready to scan.

1. To scan bar code on IV container, press **SCAN/CANCEL** key on Auto-ID Module or scan trigger on hand-held scanner.
2. Press **CHANNEL SELECT** key on appropriate module. ①
3. Program infusion (see applicable module-specific Section of this DFU). ②

CAUTIONS

- **CLASS 1 LED PRODUCT:** Do not stare into the beam or allow beam to strike patient's face.
- **Always verify** that information displayed on the PC Unit matches scanned data.

NOTES:

- ① The Alaris® System determines if the module selected is appropriate for the scanned medication type. If the selection is not appropriate (for example, a bag was scanned but a PCA Module was selected), a pop-up warning displays with a request to **CONFIRM** the message, and the scan is cancelled.
- ② If a continuous Guardrails® infusion is running, the system checks to verify scanned and infusing medication and concentration are the same. If not, an error message displays with a request to **CONFIRM** the message, and the scan is cancelled.

Secondary Infusion

To start a secondary infusion while a primary infusion is in progress:

1. To scan bar code on IV container, press **SCAN/CANCEL** key on Auto-ID Module or scan trigger on hand-held scanner.
2. Press **CHANNEL SELECT** key on appropriate module.
 - Primary infusion parameters display.
3. Press **SECONDARY** soft key.
4. Program secondary infusion (see Pump Module Section of this DFU).

CAUTIONS

- **CLASS 1 LED PRODUCT:** Do not stare into the beam or allow beam to strike patient's face.
- **Always verify** that information displayed on the PC Unit matches scanned data.

THIS PAGE
INTENTIONALLY
LEFT BLANK

General Setup and Operation

System Start-Up / Setup

See the PC Unit Section of this DFU, "General Setup and Operation", for various system start-up and setup procedures.

THIS PAGE
INTENTIONALLY
LEFT BLANK

Warnings and Cautions

WARNINGS

- Do not open the hand-held scanner case. If the case is opened, an electrical shock hazard and possible exposure to **potentially hazardous LED light** exists which can result in serious personal injury and product damage.
- Carefully locate the hand-held scanner to reduce the possibility of patient **entanglement or strangulation**.
- Use only the hand-held external scanner supplied by Cardinal Health. Using other accessories may result in **increased emissions or decreased immunity** of the Alaris® System.

CAUTION

Class 1 LED devices are safe under reasonably foreseeable conditions of operation, including the use of optical instruments for intrabeam viewing. To **avoid potential harm**, avoid looking into the beam or allowing the beam to strike the patient's face.

Hand-Held Scanner

The hand-held external scanner supplied by Cardinal Health is the only hand-held scanner approved for use with the Auto-ID Module.

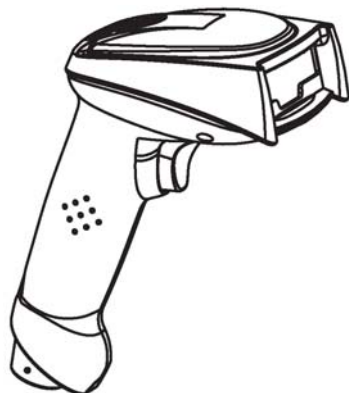

WARNINGS

- Do not open the hand-held scanner case. If the case is opened, an electrical shock hazard and possible exposure to **potentially hazardous LED light** exists which can result in serious personal injury and product damage.
- Use only the hand-held external scanner supplied by Cardinal Health. Using other accessories may result in **increased emissions or decreased immunity** of the Alaris® System.

CAUTION

CLASS 1 LED PRODUCT: Do not stare into the beam or allow beam to strike patient's face.

Features

Features and Definitions

See the PC Unit Section of this DFU for system features and definitions.

Audible Scan Indicator	Provides audible confirmation of a successful scan.
Bar Code	A machine-readable label used for automatic identification. Automatic identification (Auto-ID) is the broad term given to a host of technologies used to help machines identify objects and is often coupled with automatic data capture. These technologies include bar codes, smart cards, voice recognition, some biometric technologies (for example, retinal scans), optical character recognition and others.
Built-In Optical Scan Engine	Employs technology similar to a digital camera to read bar codes. Allows use of two-dimensional bar codes.

Features (Continued)

Features and Definitions (Continued)

Hand-Held Scanner with Optical Scan Engine

Allows scanning of patient ID, and of IV containers that have already been hung on IV pole.

Light Emitting Diode (LED)

Bar code scanner uses an array of high intensity LEDs to illuminate bar code image. (See "Specifications".)

Two-Dimensional Bar Code

Can contain more information and is more easily read by Auto-ID Module; for example, patient ID and drug ID can be in same bar code.

Operating Features, Controls, Indicators

IUI Connector, Left

IUI Connector, Right
(not visible)

READY Indicator: Green LED illuminates to provide visual confirmation that module or hand-held scanner is ready to scan.

SCAN/CANCEL Key: When initially pressed, scanning by embedded scanner is initiated. Subsequent press cancels scan.

Image Scanning Window

Hand-held external scanner connection port.

Module Release Latch:
When pressed, allows module to be removed.

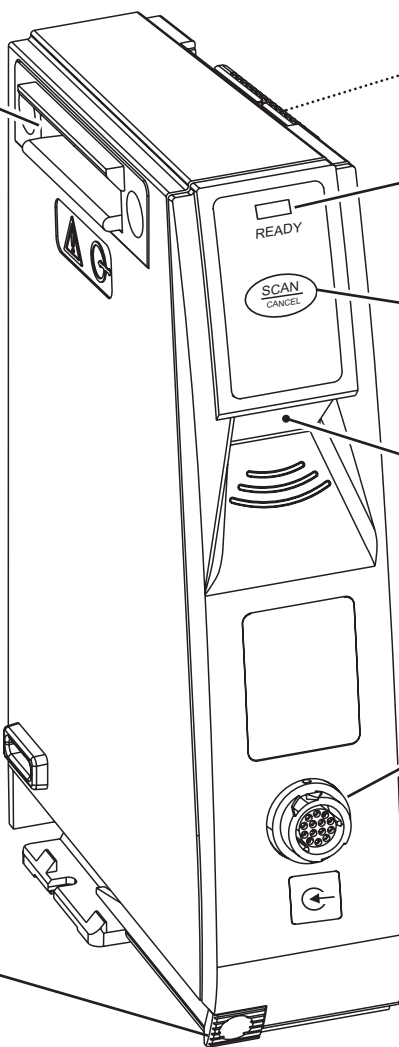

Configurable Settings

See the PC Unit Section of this DFU for system configurable settings.

If the configuration settings need to be changed from the **Factory default** settings, reference the applicable Technical Service Manual or contact Cardinal Health Technical Support, for technical, troubleshooting, and preventive maintenance information.

With the Profiles feature enabled, the settings are configured independently for each profile. A hospital-defined, best-practice Data Set must be uploaded to enable the Profiles feature. Date and Time is a system setting and is the same in all profiles.

Specifications and Symbols

Specifications

Auto-ID Module and Hand-Held Scanner

Environmental Conditions:	<u>Operating</u>	<u>Storage/Transport</u>
Atmospheric Pressure:	525 - 4560 mmHg (700 - 6080 hPa)	375 - 760 mmHg (500 - 1013 hPa)
Relative Humidity:	20 - 90% Noncondensing	5 - 85% Noncondensing
Temperature Range:	41 - 104° F (5 - 40° C)	-4 - 140° F (-20 - 60° C)
LED Light:	CLASS 1 LED PRODUCT	
Aiming LED:	523 nm, cw, 0.412 mW average radiant power	
Illumination LED:	635 nm, cw, 2.226 mW average radiant power	

Specifications and Symbols (Continued)

Specifications (Continued)

Auto-ID Module

Dimensions:	2.0" W x 7.25" H x 5.0" D (5.1 cm W x 19.8 cm H x 12.7 cm D)
Electronic Memory:	System configuration parameters stored in volatile memory are retained for at least 6 months by PC Unit internal backup lithium battery. Module-specific Auto-ID parameters are stored for 8 hours by PC Unit when system is turned off. After 8 hours of continuous off time, or if module is changed, system automatically purges module-specific information
Fluid Ingress Protection:	IPX1, Drip Proof
Mode of Operation:	Continuous
Shock Protection:	Type BF
Weight:	1 ±0.1 lb (436.5 ±43.65 g)

Hand-Held Scanner

Dimensions:	3.25" W x 7.25" H x 4.25" L (8.3 cm W x 18.4 cm H x 10.8 cm L)
Housing:	UL 94V0 flammability rating
Weight:	6.5 oz (178 g)

Specifications and Symbols (Continued)

Symbology

The Auto-ID Module and hand-held scanner read printed bar codes which are within the bar code print quality guidelines specified by ANSI X 3.182, CEN EN 1635, and ISO/IEC 15416 international standards. Some manufacturer-applied bar codes on IV bags are not compliant with these quality standards and may not be readable with the Auto-ID Module and hand-held scanner.

The Auto-ID Module and hand-held scanner can decode the following symbologies:

Aztec Code	Code 49	QR Code
Codabar	Code 93 and 93i	RSS-14
Codablock F	Data Matrix	RSS Expanded
Code 128	EAN-8	RSS Limited
Code 16K	EAN/JAN-13	TCIF Linked Code 39 (TLC39)
Code 2 of 5	EAN/UCC Composite	Trioptic Code
Code 32 Pharmaceutical (PARAF)	MicroPDF417	UCC/EAN-128
Code 39	PDF417	

Symbols

See the PC Unit Section of this DFU for system symbols.



Input. Hand-held connection point.

Troubleshooting and Maintenance

General

Alaris® System Technical Service Manuals are available from Cardinal Health. They include routine service schedules, interconnect diagrams, component parts lists and descriptions, test procedures, and other technical information, to assist qualified service personnel in repair and maintenance. Maintenance procedures are intended to be performed only by qualified personnel, using the Service Manual and System Maintenance software.

Alarms, Errors, Messages

See the PC Unit Section of this DFU for the following system references:

Alarms, Errors, Messages
Audio Characteristics
Definitions
Radio Frequency Note

Inspection Requirements

To ensure the system remains in good operating condition, both regular and preventive maintenance inspections are required. Reference the System Maintenance software for detailed instructions.

REGULAR INSPECTIONS

<u>PROCEDURE</u>	<u>FREQUENCY</u>
INSPECT FOR DAMAGE:	
Exterior Surfaces	Each usage
Keypad	Each usage
Mechanical Parts	Each usage
Seal	Each usage
CLEANING	As required
START-UP	Each usage

WARNING

Failure to perform these inspections may result in improper instrument operation.

CAUTION

Regular and preventive maintenance inspections should only be performed by qualified service personnel.

Nurse Call Accessory Model 8010

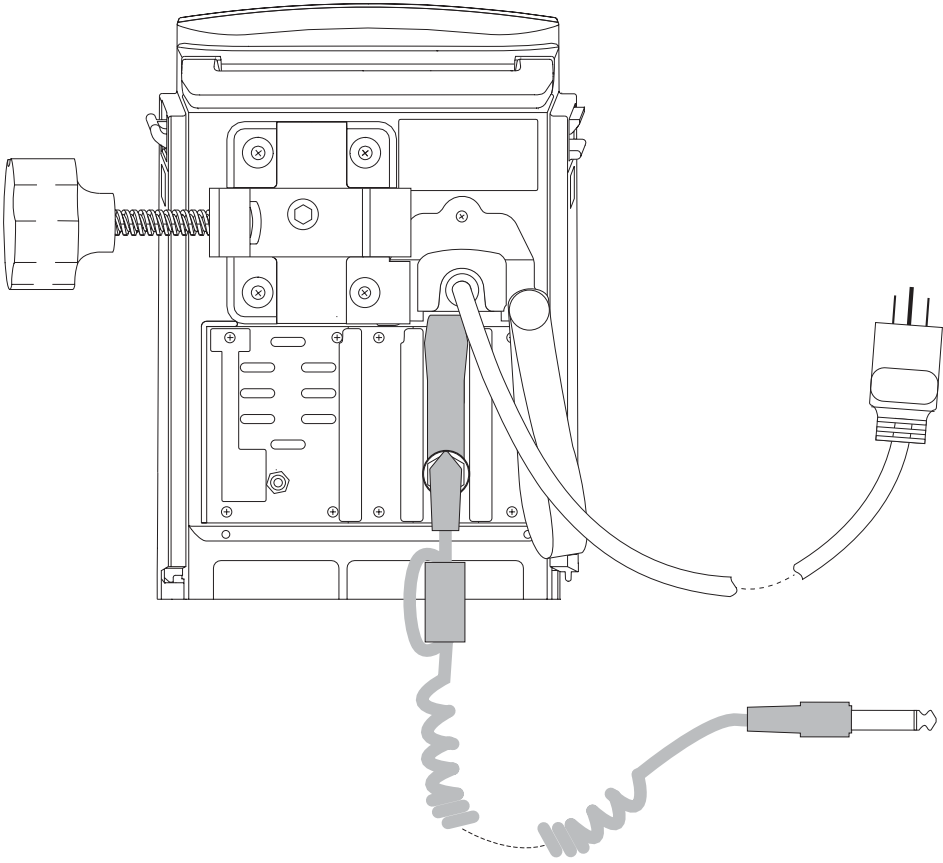

- INTRODUCTION**..... 7-1

- GENERAL INFORMATION**
 - WARNINGS AND CAUTIONS..... 7-3
 - NURSE CALL JACK AND CABLE 7-4
 - Nurse Call Location 7-4
 - Nurse Call Cable Connected..... 7-4
 - SPECIFICATIONS..... 7-5

- TROUBLESHOOTING AND MAINTENANCE**
 - GENERAL..... 7-7
 - ALARMS, ERRORS, MESSAGES..... 7-7

THIS PAGE
INTENTIONALLY
LEFT BLANK

This Section of the DFU provides Nurse Call Accessory (Model 8010) instructions and information. It is used in conjunction with:

- Module-specific Sections of this DFU
- PC Unit Section of this DFU
- Communications Interface (CI) Board Accessory Section of this DFU (if a Nurse Call and CI Combination Board Accessory is installed) ^①

The Nurse Call Accessory is an optional board installed in the PC Unit. It allows a nurse call system to be alerted when there is a significant alarm condition to the system. A contact closure routes the nurse call signal to the hospital-supplied nurse call system, and can either light a room light or send a signal/message to a console at the nurse station. A hospital-supplied cable is used to connect the Nurse Call Accessory to the hospital's nurse call jack within the patient's room. The wiring from the room to the nurse station is also hospital-supplied.

The Nurse Call Accessory uses a standard ¼" phone jack located on the rear panel of the PC Unit. A cover for the jack opening is supplied with the Nurse Call Accessory. The cover, used when the nurse call is not connected, prevents unwanted fluids and dust from entering the PC Unit.

The PC Unit is autoconfigurable and detects the presence of the nurse call option. It cannot, however, detect whether or not the nurse call cable is connected; therefore, it is important that the operation of the nurse call system be tested before each use by causing an alarm and verifying actuation of the nurse call remote alarm indication. To test the system, a module must be attached. See the applicable module-specific Section of this DFU for alarm conditions.

NOTE:

- ① The Communications Interface (CI) Board Accessory can be used in conjunction with a Nurse Call Accessory only if a Nurse Call and CI Combination Board Accessory is installed.

WARNING

Read all instructions, including those for the PC Unit and attached module(s), before using the Alaris® System.

THIS PAGE
INTENTIONALLY
LEFT BLANK

Warnings and Cautions

WARNINGS

- The nurse call feature should not be used as the primary source of alarm notification. The **audible and visual alarms** of the Alaris® System, used in conjunction with clinical signs and symptoms, are the primary sources providing notification that an alarm condition exists.
- **Before each use**, ensure the nurse call cable is fully inserted into the jack, and test the operation of the nurse call system by causing an alarm and verifying proper nurse call operation.

CAUTIONS

- To assure **compliance with Electromagnetic Compatibility** Standards (IEC 60601-1-2), the nurse call option must only be used with a properly configured hospital interface cable assembly. The approved hospital nurse call interface cable consists of an MCM Electronics 24-660 cable with an attached Fair-Rite Suppressor Core Assembly. The Fair-Rite part is included with the Nurse Call Accessory. Reference the cable assembly instructions, included with the Nurse Call Accessory, for additional information.
- **When moving the PC Unit**, ensure the nurse call cable is disconnected from the nurse call jack on the PC Unit and the fluid seal covers the jack opening.
- **Carefully route cabling** to reduce the possibility of entanglement that could result in a tripping hazard.

Nurse Call Jack and Cable

Nurse Call Location

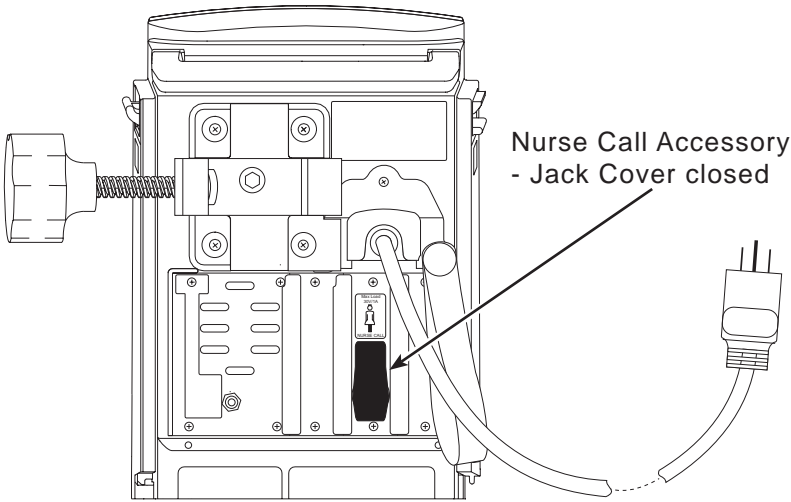

CAUTION

To prevent fluid contamination/ingress, always **close the Jack Cover** when the Nurse Call option is not in use.

Nurse Call Cable Connected

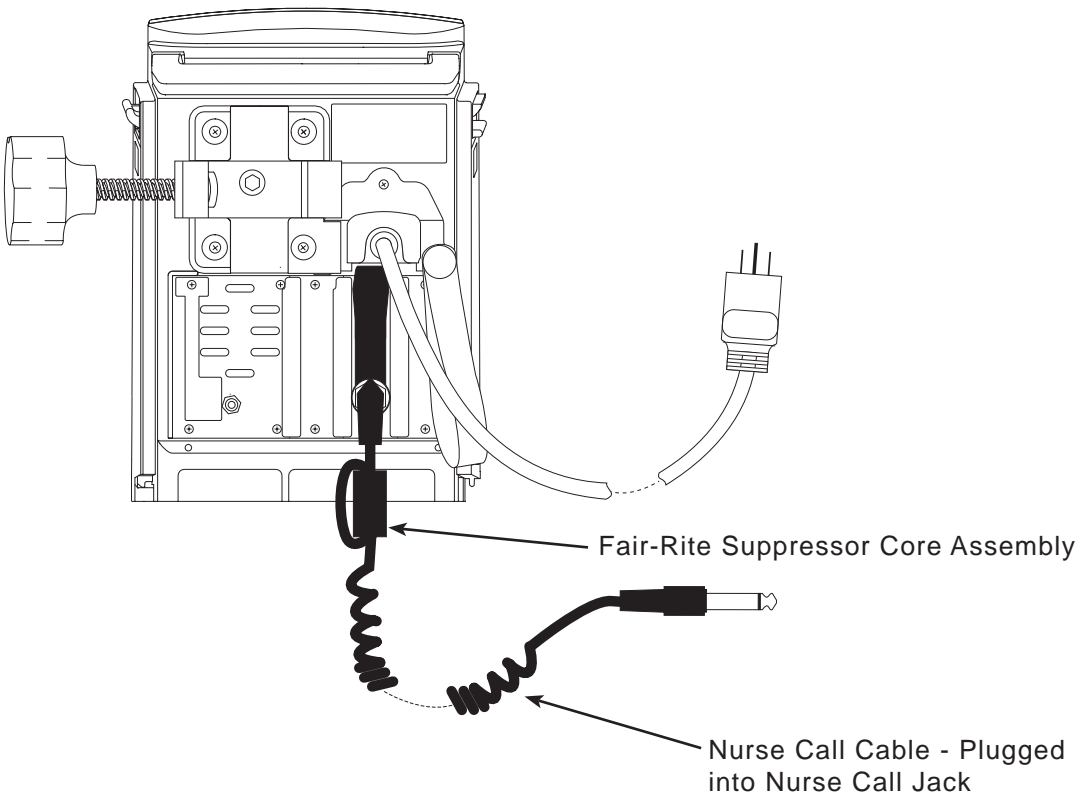

Specifications

Contact Closure Rating:	30 VDC maximum at 1A maximum
Drip Proof Protection:	To ensure Alaris® System fluid ingress rating, Nurse Call jack is covered/ sealed when not in use.
Isolation:	Nurse Call contacts are isolated from chassis up to 500 VAC.
User Accessible Connector:	¼" phone jack

THIS PAGE
INTENTIONALLY
LEFT BLANK

Troubleshooting and Maintenance

General

Alaris® System Technical Service Manuals are available from Cardinal Health. They include routine service schedules, interconnect diagrams, component parts lists and descriptions, test procedures, and other technical information, to assist qualified service personnel in repair and maintenance. Maintenance procedures are intended to be performed only by qualified personnel, using the Service Manual and System Maintenance software.

Alarms, Errors, Messages

See the PC Unit Section of this DFU for the following system references:

- Alarms, Errors, Messages
- Audio Characteristics
- Definitions
- Radio Frequency Note

Communications Interface (CI) Board Accessory Model 8012

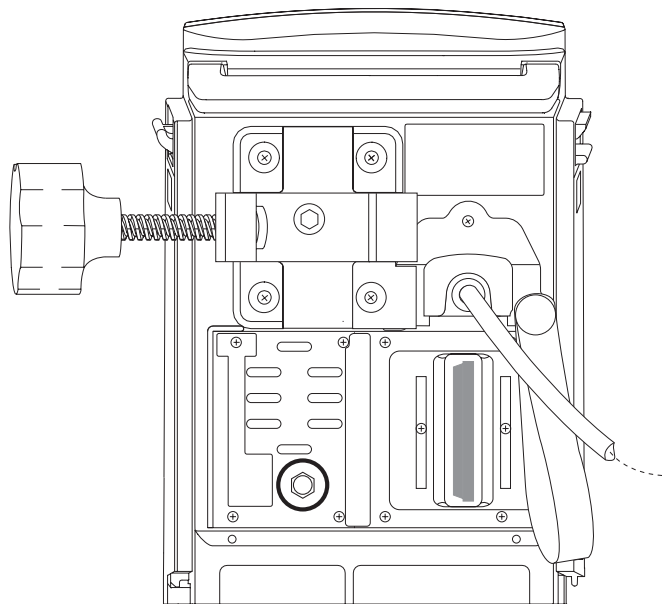

Table of Contents

INTRODUCTION	8-1
GENERAL INFORMATION	
CI BOARD ACCESSORY AND CI BOARD LED	8-3
WIRELESS NETWORK INDICATOR	8-3
TROUBLESHOOTING AND MAINTENANCE	
GENERAL.....	8-5
CI BOARD AND ALARIS® SERVER CONNECTIONS	8-5
ALARMS, ERRORS, MESSAGES.....	8-5

THIS PAGE
INTENTIONALLY
LEFT BLANK

This Section of the DFU provides Communications Interface Board Accessory ("CI Board") instructions and information. It is used in conjunction with:

- Module-specific Sections of this DFU
- Nurse Call Accessory Section of this DFU (if a Nurse Call and CI Combination Board Accessory is installed) ^①
- PC Unit Section of this DFU

The CI Board is intended to be used with an IEEE 802.11b/g 2.4 GHz wireless network. Once installed in the PC Unit, the CI Board provides wireless communication capability between the Alaris[®] System, Alaris[®] Server and Mobile Systems Manager.

Combined use of the Alaris[®] System, CI Board, Auto-ID Module, and Alaris[®] Server:

- Reduces number of manual steps needed to program an infusion (by providing information obtained from Alaris[®] Server). All data entry and validation of infusion parameters are performed, according to a physician's order, by a trained healthcare professional.
- Is integrated into a facility's existing network infrastructure.

When enabled, the Alaris[®] Server allows the exchange of information between the Alaris[®] Server and the Alaris[®] System. The PC Unit can be operated manually or in concert with the information exchanged with the Alaris[®] Server. If communication with the wireless network is interrupted (for example, out of range), the Alaris[®] System can be used, as intended, in the manual mode.

The Mobile Systems Manager does not utilize existing wireless infrastructure. It is intended to be used as a not-fully-functional substitution for the full Systems Manager in hospitals/facilities that do not have wireless communications installed. It can also be used in hospitals/facilities using the full Systems Manager but where wireless coverage is poor.

NOTE:

- ① The Communications Interface (CI) Board Accessory can be used in conjunction with a Nurse Call Accessory only if a Nurse Call and CI Combination Board Accessory is installed.

WARNING

Read all instructions, including those for the PC Unit and attached module(s), before using the Alaris[®] System.

CAUTION

Due to the **intermittent nature of a wireless environment**, some data could be lost if a connection cannot be established or is lost. The Alaris[®] Server and CI Board are designed to minimize these incidents but cannot eliminate them.

THIS PAGE
INTENTIONALLY
LEFT BLANK

CI Board Accessory and CI Board LED

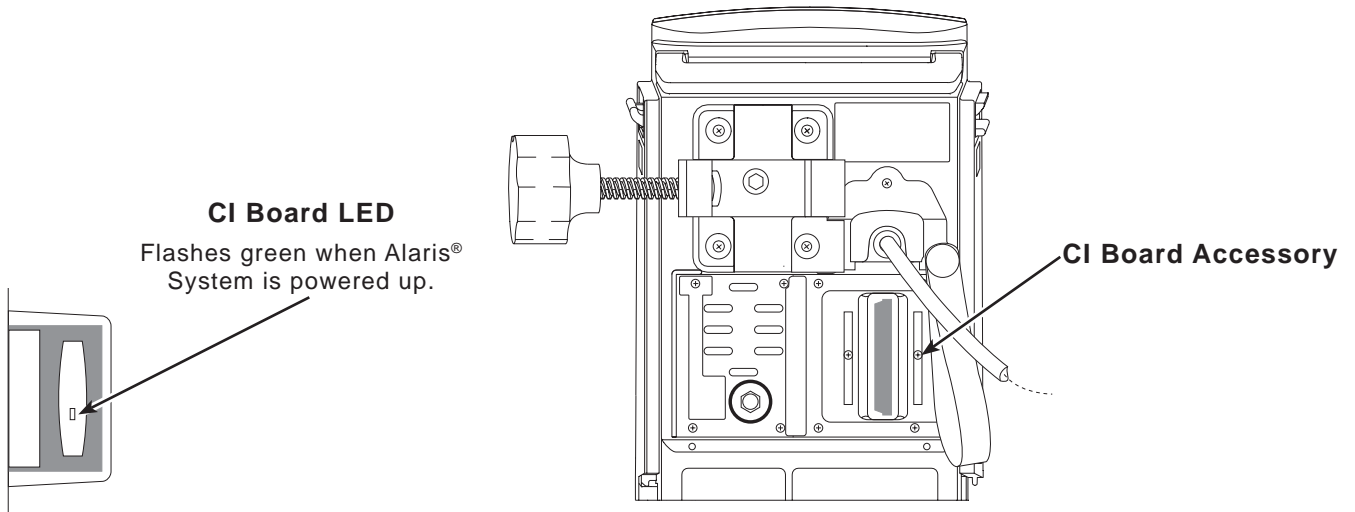

WIRELESS NETWORK INDICATOR

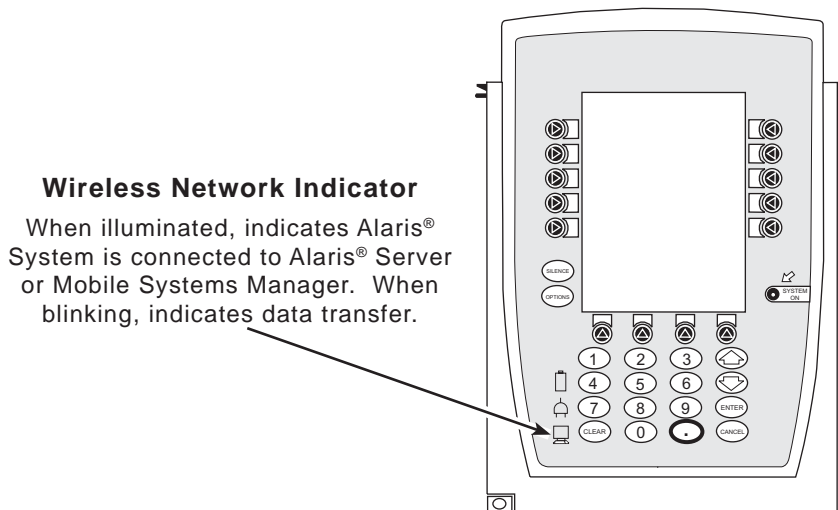

THIS PAGE
INTENTIONALLY
LEFT BLANK

Troubleshooting and Maintenance

General

Alaris® System Technical Service Manuals are available from Cardinal Health. They include routine service schedules, interconnect diagrams, component parts lists and descriptions, test procedures, and other technical information, to assist qualified service personnel in repair and maintenance. Maintenance procedures are intended to be performed only by qualified personnel, using the Service Manual and System Maintenance software.

CI Board and Alaris® Server Connections

When an Alaris® Server or Mobile Systems Manager connection is made, the Wireless Network Indicator on the PC Unit lights up. If connection to the Alaris® Server is interrupted, the indicator light is extinguished. Some of the causes for a communications failure include:

- Alaris® Server computer not running
- wireless connection access point down
- local interference
- PC Unit moved outside coverage area
- CI Board damaged

If an interruption to the Alaris® Server connection continues, the facility's information technology department should be informed.

Alarms, Errors, Messages

See the PC Unit Section of this DFU for the following system references:

Alarms, Errors, Messages
Audio Characteristics
Definitions
Radio Frequency Note

Appendix

Maintenance Regulations and Standards

Cleaning

DO NOT USE:

- solutions containing phosphoric acid (Foamy Q&A) ^①, aromatic solvents (such as naphtha, paint thinner), chlorinated solvents ^① (such as Trichloroethane, MEK, Toluene), ammonia, acetone, benzene, xylene or alcohol, other than as specified below.
- hard or pointed objects to clean any part of instrument.

All recommended solutions must be diluted per the manufacturer's recommendation. Acceptable cleaning solutions are:

2% Glutaraldehyde in water
2% Phenols in water (O-Syl 1:128, Pheno-Cen 1:256, Vesphene)
10% bleach solution (1 part bleach to 9 parts water)
70% Isopropyl Alcohol
CaviCide
Compublend II
Envirocide
Hydrogen Peroxide 3%
Mild detergent (such as Manu-Klenz)
Quaternaries 1:256 and 1:512
Sani-Cloth HB
Sani-Cloth Plus
Super Sani-Cloth
Warm water
WEX-CIDE

1. Keep instrument upright and do not allow any part of instrument to become saturated with or submersed in fluid during cleaning operation.
2. Use a soft cloth dampened with warm water and a mild nonabrasive cleaning solution to clean all exposed surfaces. A soft-bristled brush may be used to clean hard to reach and narrow areas. For sanitizing or antibacterial treatment, use 10% bleach solution and water.
3. Use a soft cloth dampened with water to rinse off cleaning solution.

WARNING

To prevent an **electrical hazard**:

- Turn the instrument off and unplug the power cord from AC power before cleaning.
- Do not spray fluids directly onto the instrument or into the IUI connectors.
- Do not steam autoclave, EtO sterilize, immerse the instrument in fluids, or allow fluids to enter the instrument case.

CAUTION

The **solutions/solvents** identified as NOT to be used can damage the surfaces of the instrument.

Cleaning (Continued)

4. Allow instrument to dry before returning to use. Dry time is dependent on temperature, humidity and area ventilation.

NOTE:

- ① Excluding 10% bleach solution in water.

WARNING

Do not use compressed air to dry the instrument; this could force fluid into the instrument.

Service Information

If the instrument shows evidence of damage in transit, notify the carrier's agent immediately. Do not return damaged equipment to the factory before the carrier's agent has authorized repairs.

If the instrument fails to respond as described in this document and the cause cannot be determined, do not use the instrument. Contact qualified Cardinal Health service personnel.

If it is necessary to return the instrument for service, obtain a return authorization number prior to shipment. Carefully package the instrument (preferably in the original packaging), reference the return authorization information, and return it to the appropriate service or distribution center. Cardinal Health does not assume any responsibility for loss of, or damage to, returned instruments while in transit.

WARNINGS

- The instrument case should only be opened by qualified personnel using **proper grounding techniques**. Prior to performing maintenance, disconnect attached module from the Alaris® System and the PC Unit from AC power.
- During servicing, an instrument's **configuration settings** might be reset to the factory defaults. Qualified hospital/facility personnel are responsible for checking in the instrument and ensuring the current hospital-approved Data Set is loaded.

Technical Support

Technical support, service information, applications, and manuals may be obtained by contacting a Cardinal Health representative.

When submitting any request for service, include:

- model number
- a description of difficulty experienced
- instrument settings
- administration set/lot number
- solution(s) used
- message displayed at time of difficulty

WARRANTY

Cardinal Health warrants that:

- A. Each new Alaris® System product is free from defects in material and workmanship under normal use and service for a period of one (1) year from the date of delivery by Cardinal Health to the original purchaser.
- B. The battery and each new accessory is free from defects in material and workmanship under normal use and service for a period of ninety (90) days from the date of delivery by Cardinal Health to the original purchaser.

If any product requires service during the applicable warranty period, the purchaser should communicate directly with Cardinal Health to determine the appropriate repair facility. Except as provided otherwise in this warranty, repair or replacement will be carried out at Cardinal Health's expense. The product requiring service should be returned promptly, properly packaged and postage prepaid by purchaser. Loss or damage in return shipment to the repair facility shall be at purchaser's risk.

In no event shall Cardinal Health be liable for any incidental, indirect or consequential damages in connection with the purchase or use of any Alaris® System product. This warranty shall apply solely to the original purchaser. This warranty shall not apply to any subsequent owner or holder of the product. Furthermore, this warranty shall not apply to, and Cardinal Health shall not be responsible for, any loss or damage arising in connection with the purchase or use of any Alaris® System product which has been:

1. repaired by anyone other than an authorized Cardinal Health Service Representative;
2. altered in any way so as to affect, in Cardinal Health's judgment, the product's stability or reliability;
3. subjected to misuse or negligence or accident, or which has had the product's serial or lot number altered, effaced or removed; or
4. improperly maintained or used in any manner other than in accordance with the written instructions furnished by Cardinal Health.

This warranty is in lieu of all other warranties, express or implied, and of all other obligations or liabilities of Cardinal Health, and Cardinal Health does not give or grant, directly or indirectly, the authority to any representative or other person to assume on behalf of Cardinal Health any other liability in connection with the sale or use of Alaris® System products.

CARDINAL HEALTH DISCLAIMS ALL OTHER WARRANTIES, EXPRESS OR IMPLIED, INCLUDING ANY WARRANTY OF MERCHANTABILITY OR OF FITNESS FOR A PARTICULAR PURPOSE OR APPLICATION.

See packing inserts for international warranty, if applicable.

Compliance

Electromagnetic Environment

Alaris® System

This system complies with part 18 of the FCC Rules. Operation is subject to the following 2 conditions:

- This system may not cause harmful interference.
- This system must accept any interference received, including interference that may cause undesired operation.

The digital apparatus does not exceed the Class B limits for radio noise emissions from digital apparatus set out in the radio interference regulations of the Canadian Department of Communications (DOC).

Le present appareil numerique n'emet pas de bruits radioelectriques depassant les limites applicables aux appareils numeriques de la Classe B prescrites dans le reglement sur le brouillage radioelectrique edicte par le Ministere des Communications du Canada.

This system has been tested and found to comply with the limits for a Class B digital device, pursuant to Part 18 of the FCC Rules. These limits are designed to provide reasonable protection against harmful interference when the system is operated in a commercial environment. This system generates, uses, and can radiate radio frequency energy. If it is not installed and used in accordance with the applicable directions for use, it may cause harmful interference to radio communications. Operation of this system in a residential area is likely to cause harmful interference, in which case the user is required to correct the interference at their own expense.

The authority to operate this system is conditioned by the requirement that no modifications are made to the system unless the changes or modifications are expressly approved by Cardinal Health, Inc.

This Class B digital apparatus meets all requirements of the Canadian Interference-Causing Equipment Regulation.

Cet appareil numerique de la Classe B respecte toutes les exigences du Reglement sur le materiel brouilleur du Canada.

CAUTION

Any **changes or modifications** not expressly approved by the personnel responsible for compliance could void the user's authority to operate the system.

Compliance

Electromagnetic Environment (Continued)

Alaris® System (Continued)

The Alaris® System may include an RF transmitter, as designated by the icon on the rear of the system. It operates on a 2400 - 2483.5 MHz frequency with a maximum radiated power of 100 mW. The registration numbers are:

Canada: 1549104431A

United States (FCC): H9PLA4137

The type LA-4137 radio card, if provided, is manufactured by Symbol Technologies, Inc., Holtsville, N.Y., 11742.

Tables: The Alaris® System is intended for use in the electromagnetic environments specified in the following tables.

Table 1
Electromagnetic Emissions

Emissions Test	Compliance	Electromagnetic Environment - Guidance
CISPR 11 RF Emissions	Group 1	<p>Alaris® System uses RF energy only for its internal function in normal product offering. If optional low power wireless network card (RF transmitter) is installed, following icon appears on product. Reference network card's directions for use for further information.</p> <div style="text-align: center;">  </div> <p>RF emissions are very low and are not likely to cause interference with nearby electronic equipment.</p>
CISPR 11 RF Emissions	Class B	Alaris® System is suitable for use in all establishments, including domestic establishments and those directly connected to a public low-voltage power supply network that supplies buildings used for domestic purposes.
IEC 61000-3-2 Harmonic Emissions	Class A	
IEC 61000-3-2 Voltage Fluctuations Flicker Emissions	Complies	

Compliance (Continued)

Electromagnetic Environment (Continued)

Alaris® System (Continued)

Table 2
Electromagnetic Immunity

Emissions Test	IEC 60601-1-2 Test Level	Compliance Level	Electromagnetic Environment - Guidance
IEC 61000-4-2 Electrostatic Discharge (ESD)	±6 kV contact ±8 kV air	±8 kV contact ^① ±15 kV air ^①	Floors should be wood, concrete, or ceramic tile. If floors are covered with synthetic material, relative humidity should be at least 30%. If connector testing exemption is used, following ESD sensitivity symbol appears adjacent to each connector. " - Do Not Touch" 
IEC 61000-4-4 Electrical Fast Transient, Burst (EFT) ^②	±2 kV for power supply lines ±1 kV for input/output lines	±2 kV for power supply lines ±1 kV for input/output lines	Mains power quality should be that of a typical commercial or hospital environment.
IEC 61000-4-5 Power Line Surge ^②	±1 kV differential mode ±2 kV common mode	±1 kV differential mode ±2 kV common mode	Mains power quality should be that of a typical commercial or hospital environment.
IEC 61000-4-8 Power Frequency Magnetic Field (50/60 Hz)	3 A/m	400 A/m 50 Hz ^① 400 A/m 60 Hz ^①	Power frequency magnetic fields should be at levels characteristic of a typical location in a typical commercial or hospital environment.

-- Continued Next Page --

Compliance (Continued)

Electromagnetic Environment (Continued)

Alaris® System (Continued)

Table 2 (Continued)
Electromagnetic Immunity

Emissions Test	IEC 60601-1-2 Test Level ^③	Compliance Level ^③	Electromagnetic Environment - Guidance
IEC 61000-4-11 Voltage Dips, Short Interruptions, and Voltage Variations ^②	<5% U_T (>95% dip in U_T) for 0.5 cycle	<5% U_T (>95% dip in U_T) for 0.5 cycle	Mains power quality should be that of a typical commercial or hospital environment. If continued operation of Alaris® System is required during power mains interruptions, it is recommended that Alaris® System be powered from an uninterruptible power supply or a battery. Alaris® System does employ an internal short duration battery.
	40% U_T (60% dip in U_T) for 5 cycles	40% U_T (60% dip in U_T) for 5 cycles	
	70% U_T (30% dip in U_T) for 25 cycles	70% U_T (30% dip in U_T) for 25 cycles	
	<5% U_T (>95% dip in U_T) for 5 sec	<5% U_T (>95% dip in U_T) for 5 sec	

Compliance (Continued)

Electromagnetic Environment (Continued)

Alaris® System (Continued)

Table 3
Electromagnetic Immunity - Life Support Equipment

Immunity Test	IEC 60601-1-2 Test Level	Compliance Level ^①	Electromagnetic Environment - Guidance ^{④ ⑤}
IEC 61000-4-6 Conducted RF IEC 61000-4-3 Radiated RF	3 Vrms 150 kHz - 80 MHz 3 V/m 80 MHz - 2.5 GHz	10 Vrms 10 V/m	Portable and mobile RF communications equipment should be used no closer to Alaris® System (including cables) than recommended separation distance calculated from equation applicable to frequency of transmitter. Recommended Separation Distance $d = \left[\frac{12}{V_2} \right] \sqrt{P}$ $d = \left[\frac{12}{E_1} \right] \sqrt{P} \quad 80 \text{ MHz} - 800 \text{ MHz}$ $d = \left[\frac{12}{E_1} \right] \sqrt{P} \quad 80 \text{ MHz} - 2.5 \text{ GHz}$ <p>d = recommended separation distance in meters (m). ^⑥</p> <p>P = maximum output power rating of transmitter in watts (W) according to transmitter manufacturer.</p> <p>Field strengths from fixed RF transmitters, as determined by an electromagnetic site survey, should be less than compliance level in each frequency range. ^{⑦ ⑧}</p> <p>Interference may occur in vicinity of equipment marked with following symbol:</p> <div style="text-align: center;">  </div>

Compliance (Continued)

Electromagnetic Environment (Continued)

Alaris® System (Continued)

Table 4 ^④ ^⑤ ^⑥ ^⑨

Recommended Separation Distances

Reduce the potential for electromagnetic interference by maintaining a minimum distance between portable and mobile RF communications equipment (transmitters) and the Alaris® System as recommended in this table, based on the maximum output power of the communications equipment.

For transmitters rated at a maximum output power not listed in this table, the recommended separation distance (d) in meters (m) can be determined using the equation applicable to the frequency of the transmitter, where P is the maximum output power rating of the transmitter in watts (W) based on the transmitter manufacturer.

Rated Maximum Output Power of Transmitter (W)	Separation Distance Based on Transmitter Frequency (m)			
	150 kHz - 80 MHz Outside ISM Bands	150 kHz - 80 MHz In ISM Bands	80 MHz - 800 MHz	800 MHz - 2.5 GHz
	$d = \frac{3.5}{V_1} \sqrt{P}$	$d = \frac{12}{V_2} \sqrt{P}$	$d = \frac{12}{E_1} \sqrt{P}$	$d = \frac{23}{E_1} \sqrt{P}$
0.01	0.04	0.12	0.12	0.23
0.1	0.12	0.38	0.38	0.73
1	0.35	1.2	1.2	2.3
10	1.11	3.8	3.8	7.3
100	3.5	12	12	23

Compliance (Continued)

Electromagnetic Environment (Continued)

Alaris® System (Continued)

NOTES:

- ① Compliance levels raised by IEC 60601-2-24.
- ② Performed at the minimum and maximum rated input voltage.
- ③ U_T is the AC mains voltage prior to application of the test level.
- ④ At 80 MHz and 800 MHz, the higher frequency range applies.
- ⑤ These guidelines may not apply in all situations. Electromagnetic propagation is affected by absorption and reflection from structures, objects and people.
- ⑥ The compliance levels in the ISM frequency bands between 150 kHz and 80 MHz, and in the frequency range 80 MHz - 2.5 GHz, are intended to decrease the likelihood that mobile/portable communications equipment could cause interference if inadvertently brought into patient areas. For this reason, an additional factor of 10/3 is used in calculating the recommended separation distance for transmitters in these frequency ranges.
- ⑦ Field strengths from fixed transmitters [such as base stations for radio (cellular/cordless) telephones and mobile radios, amateur radio, AM/FM radio broadcast, TV broadcast] cannot be predicted theoretically with accuracy. To assess the electromagnetic environment due to fixed RF transmitters, an electromagnetic site survey should be considered. If the measured field strength in the location in which the Alaris® System is used exceeds the applicable RF compliance level, the Alaris® System should be observed to verify normal operation. If abnormal performance is observed, additional measures may be necessary, such as reorienting or relocating the Alaris® System.
- ⑧ Over the frequency range 150 kHz - 80 MHz, field strengths should be less than [V.] V/m.
- ⑨ The ISM (Industrial, Scientific and Medical) bands between 150 kHz and 80 MHz are 6.765 - 6.795 MHz, 13.553 - 13.567 MHz, 26.957 - 27.283 MHz, and 40.66 - 40.70 MHz.

Communications Interface Board Accessory

The CI Board contains a radio frequency IEEE 802.11b, wireless, local-area network interface (RF card). The RF card allows the Alaris® System to communicate with the Alaris® Server connected to the hospital information system. The RF card is compliant with the rules and regulations in the locations where the CI Board is sold, and is labeled as required.

The United States Federal Communications Commission (FCC) and Canadian Department of Communications (DOC) identification numbers are visible through the CI Board's clear plastic cover. If an international country approval stamp is required, it is placed adjacent to the identification numbers in the area provided.

Compliance (Continued)

Electromagnetic Environment (Continued)

Communications Interface Board Accessory (Continued)

The Class B digital device limits are designed to provide reasonable protection against harmful interference when the device is operated as intended. This device generates, uses, and can radiate radio frequency energy. If it is not installed and used in accordance with the applicable directions for use, it may cause harmful interference to radio communications. Operation of this device in a residential area is likely to cause harmful interference, in which case the user is required to correct the interference at their own expense. There is, however, no guarantee that interference will not occur in a particular installation.

If the device does cause harmful interference to radio or television reception (determined by powering system off and on), one or more of the following corrective actions should be taken:

- Reorient or relocate receiving antenna.
- Increase separation distance between system and receiver.
- Connect system into an outlet on a circuit different from that to which receiver is connected.

This Class B digital device meets the requirements of the Canadian Interference Causing Equipment Regulations.

Cet appareil numérique de la Classe B respecte toutes les exigences du Règlement sur le Matériel Brouilleur du Canada.

This Class B digital device meets the requirements of the International community.

Compliance (Continued)

Federal Aviation Regulations

The following Alaris® products have received a Statement of Compliance with Federal Aviation Regulations for use as a "Portable Electronic Device Aboard Aircraft". This is pursuant to the FAA Advisory Circular No. 91-21-1A and attested by an FAA Designated Engineering Representative with an FAA form 8110-3, "Statement of compliance with the Federal Aviation Regulations".

PC Unit
Pump Module
Syringe Module

Standards

The Alaris® System has been assessed and complies with the following standards:

PC Unit and overall System: UL 60601–1, CAN/CSA C22.2 No. 601.1–M90, IEC 60601–1

Auto-ID Module: IEC 60825–1 (LEDs used in Auto-ID Module are not regulated by FDA in the United States; however, they are classified as a CLASS 1 LED PRODUCT in other countries under this standard.)

Communications Interface Board Accessory: Class B digital device limits pursuant to Parts 15 (RF Devices and Computing Devices) and 18 (Medical Devices) of the FCC Rules and Regulations. To comply with FCC and Industry Canada exposure requirements, the CI Board is approved for operation when there is more than 20 cm between the antenna and the user's or patient's body.

EtCO₂ Module: ISO 9918, ASTM F 1456-01, ASTM F 1463, EN 475, EN 864

PCA, Pump and Syringe Modules: IEC 60601-2-24, ANSI/AAMI ID:26

SpO₂ Module: EN 865

Trademarks

Alaris®, Guardrails® and SmartSite® are registered trademarks of Cardinal Health, Inc. or one of its subsidiaries. LNOP®, Masimo®, SET®, Signal Extraction Technology® and Signal I.Q.™ are trademarks of Masimo Corporation. Nellcor® is a registered trademark of Nellcor Puritan Bennett, Inc. Microstream® is a trademark of Oridion Medical 1987 Ltd. All other trademarks belong to their respective owners.

